

GTV

LIGHTING

LIGHTING

P R O D U C T S



KATALOG | CATALOGUE | КАТАЛОГ | КАТАЛОГ



GTV
LIGHTING

GTV Poland to międzynarodowy producent i jedna z czołowych firm na polskim rynku oświetlenia. Oferuje pełną gamę produktów - od źródeł światła po przeznaczone dla konkretnej inwestycji rozwiązania oświetleniowe. Portfolio - jedno z bardziej kompletnych na rynku - obejmuje kilka tysięcy produktów w kilkudziesięciu grupach produktowych. GTV Poland to nowoczesna i profesjonalnie zarządzana firma, a jednocześnie zaufany partner biznesowy dla kontrahentów na całym świecie.

PL

GTV Poland is an international producer and one of the leaders in the Polish lighting market. The Company offers a complete range of products - from light sources to those designed for specific investment lighting solutions. The Portfolio - one of the most extensive in the market - is comprised of thousands of products in several dozen product groups. GTV Poland is a modern company with professional management and, at the same time, a reliable worldwide business partner.

EN

GTV Poland - это международный производитель и одна из ведущих компаний на польском рынке освещения. Компания предлагает полный спектр продуктов - от источников света по предназначенное для конкретной инвестиции комплексное освещение. Портфолио - одно из самых полных на рынке - включает в себя несколько тысяч продуктов, в нескольких десятках группах продукции. GTV Poland - это современная и профессионально управляемая компания, одновременно она является надежным деловым партнером для подрядчиков по всему миру.

RU

GTV Poland - це міжнародний виробник і одна з провідних компаній на польському ринку освітлення. Фірма пропонує повний спектр освітлювального обладнання - від світлодіодних лампочок, до продуктів, призначених для конкретних інвестиційних проектів. Портфоліо - одно з найбагатших на ринку - включає в себе декілька тисяч продуктів, в десятках продуктивних групах. GTV Poland це сучасна і професійно керована компанія, одночасно вона є надійним діловим партнером для клієнтів по всьому світу.

UK

**ŹRÓDŁA ŚWIATŁA
 LIGHT SOURCES
 ИСТОЧНИКИ СВЕТА
 ДЖЕРЕЛА СВІТЛА**

Źródła Światła LED LED light sources Светодиодные источники света Світлодіодні джерела світла.....	22
---	----

Świetlówki LED typu T8 LED light sources T8 Светодиодные лампы типа T8 Світлодіодні лампи типу T8.....	60
---	----

**OPRAWY TECHNICZNE I PRZEMYSŁOWE
 TECHNICAL AND INDUSTRIAL FIXTURES
 ТЕХНИЧЕСКИЕ И ПРОМЫШЛЕННЫЕ СВЕТИЛЬНИКИ
 ТЕХНІЧНІ ТА ПРОМИСЛОВІ СВЕТИЛЬНИКИ**

Panele i oprawy LED LED panels and fixtures Светодиодные панели Світлодіодні панелі.....	65
---	----

Oprawy przemysłowe LED Industrial LED fixtures Светодиодные промышленные светильники Світлодіодні промислові світильники.....	76
--	----

Plafoniere i oprawy kanałowe LED LED ceiling and bulkhead fixtures Потолочные светильники и светильники ЖКХ Світлодіодні світильники та світильники ЖКХ.....	86
---	----

Oprawy LED typu downlight LED downlights Светильники типа downlight Світильники типу downlight.....	104
--	-----

Naświetlacze LED LED Floodlights Светодиодные прожекторы Світлодіодні прожекторы.....	126
--	-----

Oprawy LED typu high bay High bay LED luminaires Светодиодные High bay светильники Світлодіодні high bay світильники.....	132
--	-----

Oprawy uliczne i parkowe LED Street and park LED luminaires Светодиодные уличные и парковые светильники Світлодіодні вуличні та паркові світильники.....	138
---	-----

Oprawy awaryjne LED LED emergency light fixtures Аварийные светильники Аварійні світильники.....	142
---	-----

Oprawy rastrowe, kloszowe Louvre fixtures Растровые светильники Растрові світильники.....	146
--	-----

Oprawy przemysłowe Industrial fixtures Промышленные светильники Промислові світильники.....	150
--	-----

Plafoniere i oprawy kanałowe Ceiling and bulkhead fixtures ЖКХ светильники ЖКГ світильники.....	154
--	-----

**OPRAWY DEKORACYJNE
 DECORATIVE FIXTURES
 ДЕКОРАТИВНЫЕ СВЕТИЛЬНИКИ
 ДЕКОРАТИВНІ СВЕТИЛЬНИКИ**

Oprawy sufitowe Ceiling fixtures Потолочные светильники Стельові світильники.....	169
--	-----

Oprawy punktowe Spot light fixtures Точечные светильники Точкові світильники.....	220
--	-----

Oprawy ogrodowe i elewacyjne Garden and wall fixtures Садовые и фасадные светильники Садові та фасадні світильники.....	248
--	-----

Lampki Desk lamps Настольные лампы Лампи настільні.....	294
--	-----

SYSTEMY SZYNOWE TRACK SYSTEMS ТРЕКОВЫЕ СИСТЕМЫ ОСВЕЩЕНИЯ ТРЕКОВІ СИСТЕМИ ОСВІТЛЕННЯ	314
--	------------

Systemy szynowe 1 fazowe 1-phase rail systems 1-фазовые трековые системы 1-фазові трекові системи.....	317
---	-----

Reflektory LED Spot lights LED Трековые светильники Трекові світильники.....	318
---	-----

Szynoprzewody Rails Шинопроводы Шинопроводы.....	322
---	-----

Systemy szynowe 3 fazowe 3-phase rail systems 3-фазовые трековые системы 3-фазові трекові системи.....	325
---	-----

Reflektory LED Spot lights LED Трековые светильники Трекові світильники.....	326
---	-----

Szynoprzewody Track systems Шинопровод Шинопрвід.....	338
--	-----

OSPRZĘT ELEKTROINSTALACYJNY INSTALLATION FITTINGS ЭЛЕКТРОУСТАНОВОЧНЫЕ ИЗДЕЛИЯ ЕЛЕКТРОМОНТАЖНІ ВИРОБИ.....	352
--	------------

Osprzęt elektroinstalacyjny Installation fittings Электроустановочные изделия Електромонтажні вироби.....	355
--	-----

OŚWIETLENIE MEBLOWE / PROFILE LED FURNITURE LIGHTING / LED PROFILES ОСВЕЩЕНИЕ МЕБЕЛИ / ПРОФИЛИ ДЛЯ СВЕТОДИОДНЫХ ЛЕНТ ОСВІТЛЕННЯ МЕБЛІВ / ПРОФІЛЬ ДЛЯ СВІТЛОДІОДНОЇ СТРИЧКИ.....	398
--	------------

Taśmy LED / Profile LED LED strips / LED profiles Светодиодные ленты / Профили LED Стрічки led / Профілі led.....	401
--	-----

Oprawy LED LED fixtures Светодиодные светильники Світлодіодні світильники.....	438
---	-----

Aksesoria Accessories Аксессуары Акcesуари.....	446
--	-----

Gniazda meblowe Power sockets Удлинитель Подовжувачі.....	475
--	-----



Źródła światła
Light sources
Источники света
Джерела світла

 NEW	 NEW	 NEW	 NEW		 NEW
LD-SMGC30B-30 26	LD-C35FLE4M-30 26	LD-SMDC37-80 26	LD-SMGC30L-30 27	LD-SMC37L-80 27	LD-C35FLE4M-30L 27
 NEW	 NEW	 NEW	 NEW	 NEW	
LD-SMC37L-10 28	LD-SMGB45B-30 28	LD-SMB45B-80 28	LD-G45FLE4M-30 29	LD-SMB45B-10 29	LD-E14S2WE0-40 30
		 NEW	 NEW	 NEW	 NEW
LD-E14P35WE-30 30	LD-R5060W-30 30	LD-C35FLE4-30 31	LD-C35FLE4-30L 31	LD-G45FLE4-30 31	LD-C35FP4-18 32
 NEW	 NEW				
LD-C35FP4-18L 32	LD-G45FP4-18 32	LD-PC2A60-8W 33	LD-PC3A60-10W 33	LD-PC2A60-12 33	LD-PC3A60-15W 34
			 NEW		
LD-PC3A65-18W 34	LD-PC4A65-20W 34	LD-PC2A60-6W 35	LD-A60FLE8M-30 35	LD-R6380W-30 35	LD-PC2A60RGBW 37
				 NEW	 NEW
LD-A60CZ3-10W 37	LD-A60CM3-10W 37	LD-SPCA60-10W 39	LD-DC24A60-12 39	LD-SMGC30C-60 39	LD-SMGB45C-60 41

	 NEW	 NEW	 NEW		 NEW
LD-SMBD45-80 41	LD-G45FLE2EM-30 41	LD-G45FLE2EM-40 42	LD-SMBD45-10 42	LD-120G14W-32 42	LD-ALF100-27W 43
 NEW	 NEW	 NEW	 NEW	 NEW	 NEW
LD-A60FLE8-30 44	LD-G95FLE8-30 44	LD-G125FLE8-30 44	LD-ST64FLE6-30 45	LD-ST64FVE4-30 46	LD-G95FEV4-30 46
 NEW	 NEW	 NEW	 NEW	 NEW	 NEW
LD-G125FEV4-30 46	LD-A60FP8-18 48	LD-G95FP8-18 48	LD-G125FP8-18 48	LD-ST64FP4-18 49	LD-G93WE25-30 50
					 NEW
LD-G93W25-32 50	LD-G9PE35W-30 50	LD-G9P67W0-30 51	LD-G9P95W0-30 51	LD-SPCGU10-7W 51	LD-NGU10P-1W 52
				 NEW	
LD-SZ1510-30 52	LD-PC6010-30 52	LD-SM1210-10 53	LD-SZ5010-30 53	LD-SZ30W10-30 53	LD-J7806WE-40 54
			 NEW	 NEW	 NEW
LD-J7805WCE-40 54	LD-J11810WE-40 54	LD-J11809WCE-40 55	LD-ES111WW13W40-10 56	LD-ES111WW13W40-00 56	LD-AR111WW13W40-10 56
 NEW					
LD-ES111WW11W25A0 57	LD-SM4016-30 57	LD-SM4016-30 57	LD-G4S115-32 58	LD-G4P30W-30 58	LD-G4018W-30 58

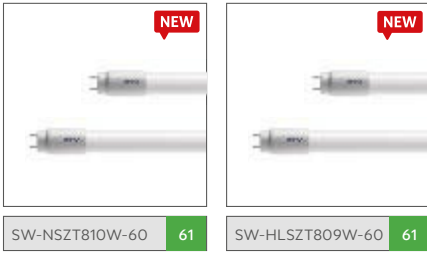

SW-NSZT810W-60 61

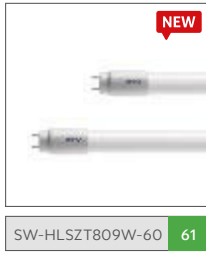

SW-HLSZT809W-60 61



Опрavy техничные и промышленные
Technical and industrial fixtures
Технические и промышленные светильники
Технічні та промислові світильники

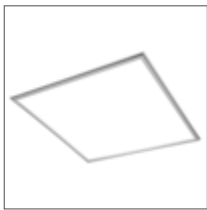

LD-AKO4060-NB 66



LD-SOL36W40-NB 66



LD-MOD4060-NB 68



LD-MOD4060-NB 68

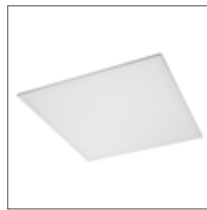

LD-GL40060-NB 69

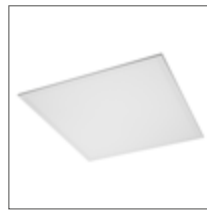

LD-GL40060UGR-NB 70



LD-MA24063-NB 70



LD-KNG45060-NB 72



LD-ARG30W60-NB 72



LD-DE40062-NB 73



LD-DE40062UGR-NB 73



LK-PANELX4-00 74



ZM-PANELSC-00 74



ZM-PANELSU-00 74



RM-DE625X625-00 75



LD-BERGA50W-30 77



LD-BETISD50W-30 77



LD-LUNAR60-40 78



LD-BESTA40W-30 78



LD-XARO18W-30 80



LD-HR2X18W12-30 80



LD-OMNO60-30B 81



LD-OMN120B-75M 81



LD-LUM120-30P 82



LD-HER60W12-NB 82



LD-LNG24WB-NB 83



LD-ZFPL24W06-NB 83





























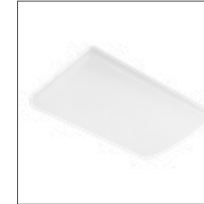











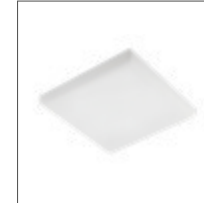

LD-OLL20W-CB 84







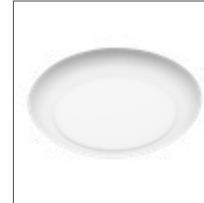















LD-ONT120-36 84



LD-ONTEND-00 85

		 NEW			 NEW
LD-BES24WOK-30 87	LD-BES24WKW-30 87	LD-STARS24W-NB 88	LD-MOON12W-NB 88	LD-FEN20W-NW-00 90	LD-SATU12W-NW-00 90
	 NEW				
LD-SATU12WM-NB 91	LD-ATOL32W-NW-10 91	LD-TOK22W-40 92	LD-TOK16WP-40 92	LD-TOK16WD-40 93	LD-OSA16WD-40 93
 NEW	 NEW	 NEW			
LD-ASTID13-NW-00 95	LD-ASTR12W-NW-00 95	LD-ASTR12WM-NW 96	LD-LOG16W-LED 96	LD-MCR12W-NB 97	OS-ITL12W-LED 98
					
OS-ITL12WKW-LED 98	LD-KALU10OK-40 99	LD-KALU10OW-40 99	LD-TWI10WOK-40 100	LD-TWI10WOW-40 100	LD-DELOR6WC-NB 102
					
LD-DELOW6WC-NB 102	LD-KD08WOV-NB 103	LD-KD08WOK-NB 103	LD-SRW12WOK-NB 105	LD-SRW12WKW-NB 105	LD-ORN07W-CBP 106
 NEW			 NEW		
LD-ORN07W-CBP-10 106	LD-ORW03W-CBP 107	LD-ORW03W-NBP4 107	LD-ORW07W-CBP-10 108	LD-MAN07W-CBP 108	LD-MAW03W-CBP 109
	 NEW	 NEW			
LD-MAW03W-CBP4 109	LD-MAN07W-CBP-10 110	LD-MAW07W-CBP-10 110	LD-MZ12WOK-NB 111	LD-MZ12WKW-NB 111	LD-LSNO06W-NB 112

					
LD-LSNK06W-NB 112	LD-LSW003W-NB 114	LD-LSWK03W-NB 114	LD-SMBOK07W-21 115	LD-SMBKW07W-21 115	LD-BLROK18W-61 116
					 NEW
LD-BLRKW18W-61 116	LD-TWN09W-CB 118	LD-TW09W-CB 118	LD-VLROK0538-CB 120	LD-VLRKW0538-CB 120	LD-VLROK0738-CCT 121
 NEW					 NEW
LD-VLRKW0738-CCT 121	LD-DNV15W-NB 122	LD-ARZ18W-CCT 122	LD-KAR18W-CCT 124	LD-ARC15W-NB 125	LD-VIPERS30W-40 127
					
LD-VIPERS30W-40 127	LD-INEXT10W-64 128	LD-INEXT30WP-64 128	LD-ILUXC10W-64 130	LD-ILUXC100W-64 130	LD-ALCX10W-64 131
					
LD-OXCX10W-64 131	LD-TK100W-40 133	SO-TK060DE-00 133	LD-HB150W-40 134	RF-HB150W-40 134	LD-KAN150W-NB 136
					
LD-DAL100W-NB 136	LD-PARK3L30W-40 139	SA1 139	LD-IND60W-40 140	LD-STEL080W-40 140	LD-SAHER1-DUO 143
			 NEW		
LD-TERNO1-00 143	OA-SALED1-08 144	LD-CORSO1-00 144	LD-OGLA3W-00 145	LD-OMAH33-00 145	OS-OSL1120S-00 147



OS-OSL2120S-00 147



OS-LE150NJ-01 148



LD-OZE218-00 151



LD-OZE218-01 151



LD-HAG136-30 152



LD-HEL136B-30 152



LD-HAG236KL-ME 153



OS-HERZW1-00 153



OS-PLCRKM-00 155



OS-PLCRKZ-00 155



OS-PLCZMI-00 156



OS-PLCZOO-00 156



OS-IBBL060-00 157



OS-IBKR060-00 157



OS-RING01-00 158



OS-KACROO-00 158



OS-KAY060-00 160



OS-KAM060-00 160



OS-KAN527-24 163



OS-KAG508-10 163



LT-LC6WT3-60 163



LT-LK3WBL-60 164



LT-LKSZ3W-60 164



LT-LB6WT2-60 164



LT-LB8WT6-60 165



LT-LB3WT4-60 165































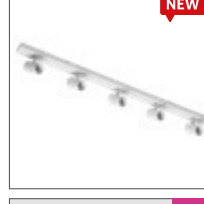

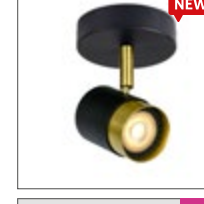
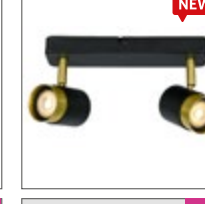
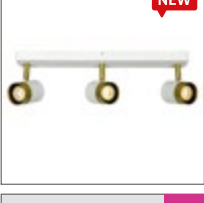





























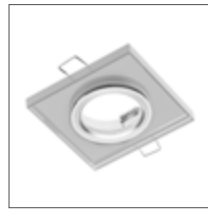



















LT-LA8WT2-60 165



Опrawy dekoracyjne
Decorative fixtures
Декоративные светильники
Декоративні світильники

LD-OME50WNB-10-A 170	LD-OME30WNB-10-L 170	LD-OME30WNB-10-T 170	LK-OMEGA-OP 170	LD-LUN40WNB-10-A 172	RM-LUNA120-10 172
LD-LIV40WNB-10 173	LD-VIL42WUDB-NB 173	LD-FRT36WB-NB 174	LD-JAS15W-40 174	LD-ZIT600W-01 175	LD-PRM10WB-NB 175
LD-BNC8WKB-NB 176	LD-BNC8WOB-NB 176	LD-BNCC8WOB-NB 178	LD-BNCC8WKB-NB 178	LD-BNCC16WOB2-NB 179	LD-BNC15WKB-NB 180
LD-BNC15WOB-NB 180	LD-SRA08WB-NB 182	LD-SRA18WB-NB 182	LD-ATM15WBP-NB 184	LD-ATM20WBK-NB 184	OS-TENGU10-10 186
OS-TENGU10KW-10 186	OS-AERD20W-10 188	OS-LAG20W-10 189	OS-TRES320W-00 189	OS-AVB8090OK1-10 190	OS-AVB8090KW1-10 190
OS-AVB80160OK2-10 192	OS-AVB80160KW2-10 192	OS-SEN5081OKCZ 194	OS-SEN5091KW 194	OS-SEN5087OKCZ-10 196	OS-SEN5097KW-10 196

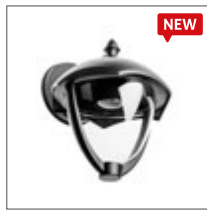
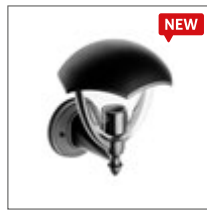
					
OS-SENAQ5087OKB 197	OS-SEND5083OKB 197	OS-RST80125OK1-10 198	OS-RST8080KW1-10 198	OS-ARIQK-11 200	OS-ARIKW-11 200
					
OS-DRAGO14-10 201	OS-BLND50W1-10 202	OS-BLND50W2-10 203	OS-BLND50W3-10 203	OS-FRG20W2-10 204	OS-FRG20W2-10-MINI 204
					
OS-SAN20WOK1B-10 205	OS-SAN20WOK2B-10 205	OS-REN20WKW1-10 206	OS-REN20WKW2-10 206	OS-VEN20W01-00 207	OS-VEN20W02-00 207
					
OS-VEN20W03-00 208	OS-VEN20W04-00 208	OS-VEN20W05-00 209	OS-VEN20WOK4-00 209	OS-ORI-GU10-00 210	OS-ORI-2GU10-00 210
					
OS-ORI-3GU10-00 211	OS-LUP-GU10-00 212	OS-LUP-2GU10-00 212	OS-SAKES111-10 213	OS-SAKES111KW-10 213	OP-PIREN1-00 214
					
OP-PIREN2-00 214	OS-ISUES111-10 216	OP-PIRE01-20 217	OP-PIRE02-20 217	OS-CAMD40WG9OK 218	OS-CAM40WG9KW 218
					
OP-PAST1-01 221	OP-PADST3-01 222	OP-PADRK3-01 223	OP-PROD3-01 224	OP-PROD4-01 225	OP-PRAN5-01 226

					 NEW
OP-PRAN6-01 227	OP-OPROKR-21 228	OP-OPRKWT-21 228	OP-OPRKW1-80 229	OP-OPROK1-80 229	OP-CANOKB-10 230
 NEW					
OP-CANKWB-10 230	OP-SALOK-10 231	OP-SALKW-10 231	OP-PALACEDOK-10 232	OP-PALACEDKW-10 232	OP-MAROK-10 234
 NEW	 NEW				
OP-ARIOK-11 235	OP-ARIKW-11 235	OP-AUROKB-10 236	OP-AURKWB-10 236	OP-LINTOK-10 238	OP-KERLKW-10 238
					
OP-ELVAOBB-10 239	OP-ALSOK-10 240	OP-ALSKW-10 240	OP-RUBIOKW1-10 242	OP-RUBIOKW2-10 242	LD-ESOA084-51 244
			 NEW		
LD-ESOB084-51 244	LD-ESKA084-51 246	LD-ESKB084-51 246	LD-KAT400-01 247	OS-MILA00A-00 249	OS-MILA10P-00 249
 NEW			 NEW	 NEW	 NEW
OS-CORP40-30 250	OS-KERTP40-30 252	OS-KEMIOUA-30 254	OS-MEDOAU-30 256	OS-LARGOUA-30 258	OS-GRA0DA-00 260
		 NEW	 NEW	 NEW	
OS-USTIP40-30 261	OS-USTI0UD-30 261	OS-GRA0DA-00 262	OS-GRA0UA-00 262	OS-GRA00P-00 262	OS-MARINADA-00 264



OS-MARINAUA-00 264



OS-MARINAH-00 264



OS-MARINAP-00 264



OS-TOSODA-80 266



OS-ASTRITE27-80 266



OS-ESOE2711-80 268



OS-VENTANAH-00 268



OS-LEN100OKG-30 270



OS-LEN100KWG-30 270



OS-RIV102KWG-30 271



OS-RIV102OKG-30 271

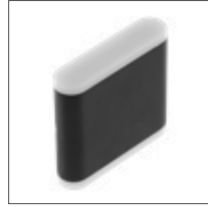

LD-VALLA8W-40 272



LD-MISS7WOC-NB 273



LD-MISS7WKC-NB 273



LD-CANTI12WOK-40 274



LD-CANTI12WKW-40 274



LD-PAR10W40BC-00 276



LD-PAR10W40-00 276



LD-NESSAGU10J-80 278



LD-NESSAGU10D-80 278



LD-SILVAGU10J-80 280



LD-SILVAGU10D-80 280



LD-TIAGOGU10J 282



LD-TIAGOGU10D 282

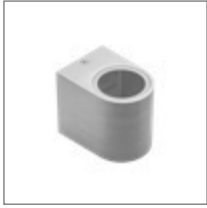

LD-TIAGOGU10J-01 284

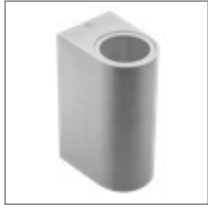

LD-TIAGOGU10D-01 284



LD-BALGU10-00 285



LD-BA2E27-00 285

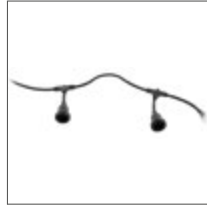

AE-GR610-10 286



AE-GIR10-10 287



OS-DIEGOGU10-80 288

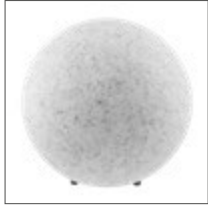

OS-MARMO25-00 289



OS-GRAZIEGU10-20 290



ON-ALFAOGU10-06 292



ON-ALFAOGU10 MINI 291



ON-BETAOGU10RK-06 292



ON-ALFAO-C1W 292



LB-GAL3WRU-10 295



LB-GAL5WRU-10 295



LB-HAL8W-00-DEC 296



LB-FRO5W-00-DEC 296



LB-FLOW4W-06-DEC 298

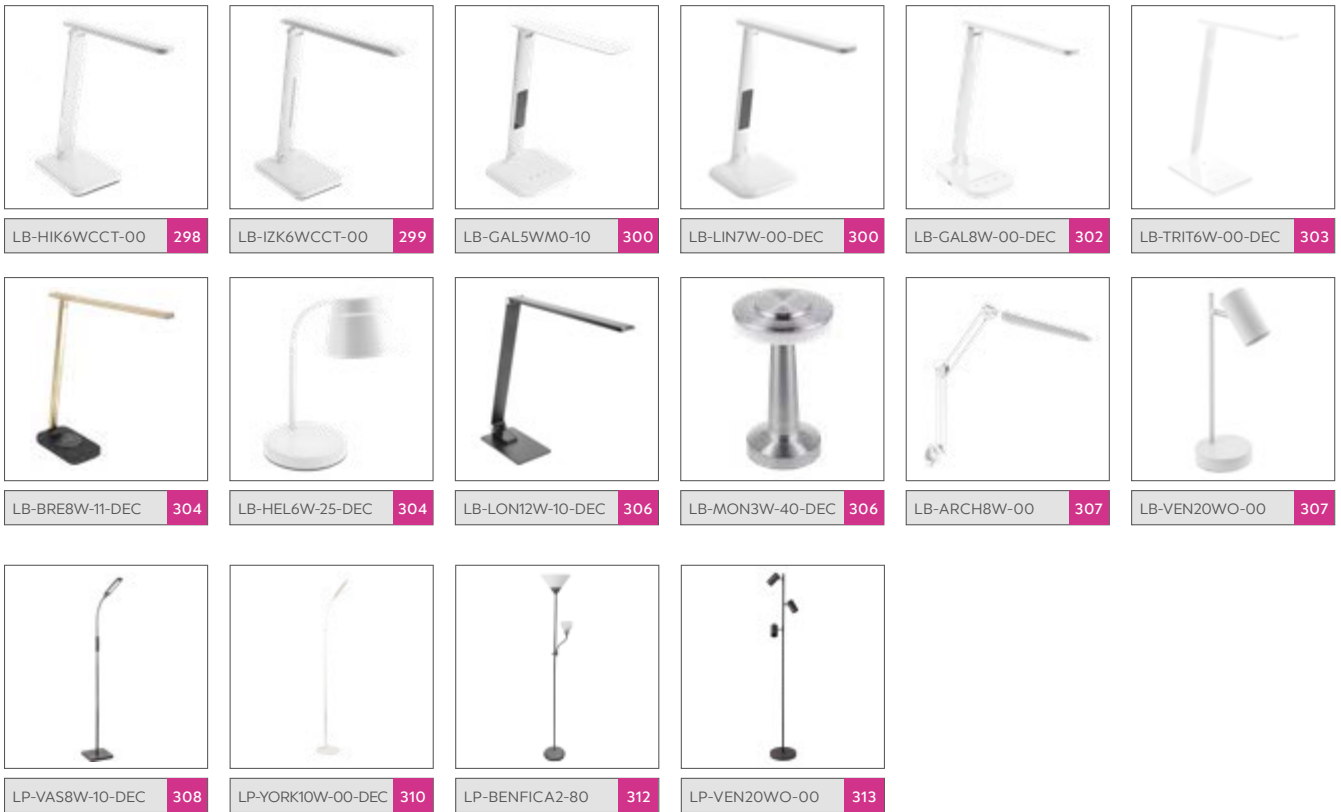

Systemy szynowe
Track systems
Трековые системы освещения
Трекові системи освітлення

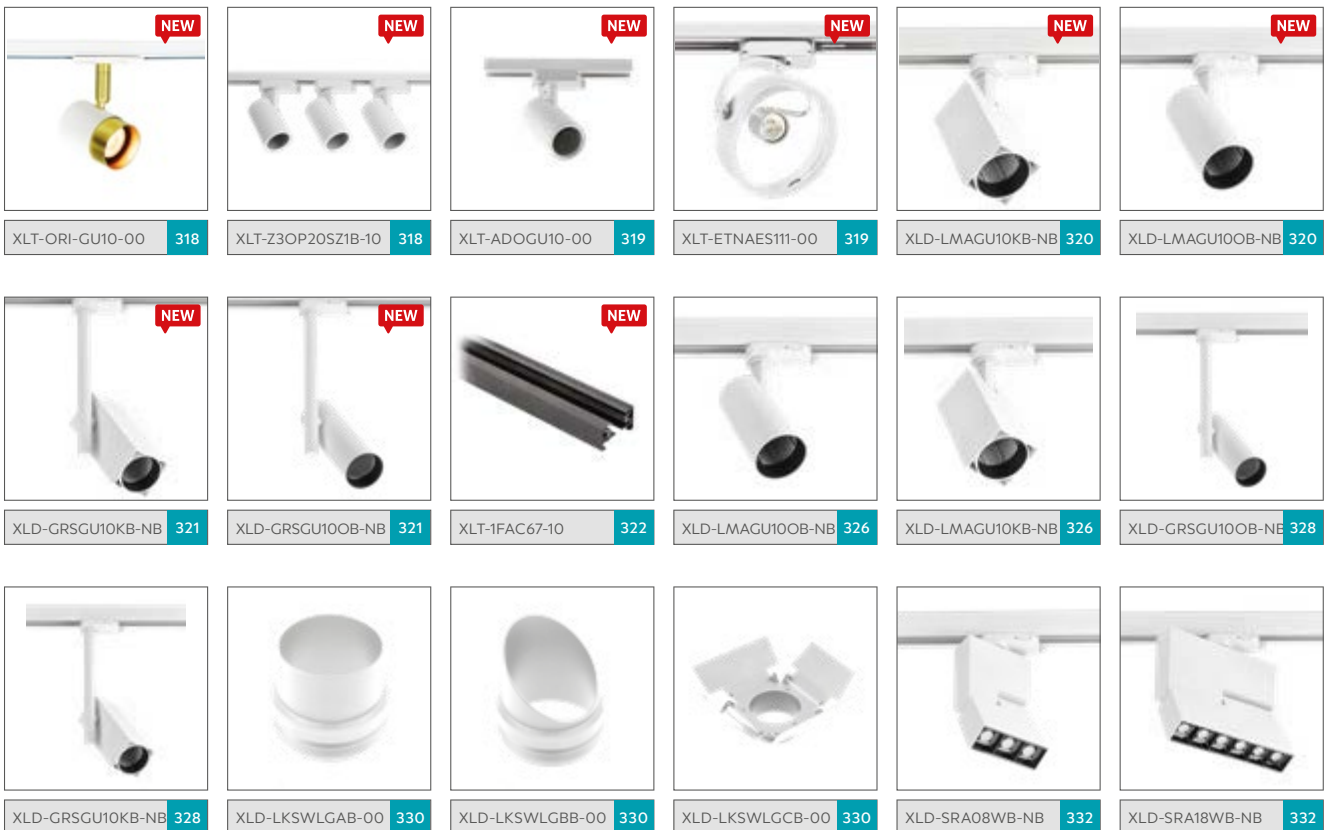



TLD-12W38LN-NBO 334



XLD-1524XLN-NBO 336

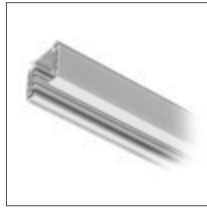

XTR-RA3FZ1B-00 339



XAE-KZASPB-00 339



XAE-KZASLB-00 339



XAE-LKLRZWB-00 340

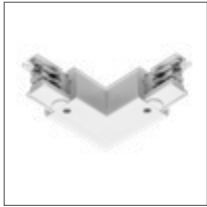

XAE-LKLLZB-00 340

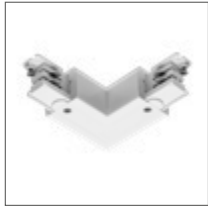

XAE-LKLPWB-00 340

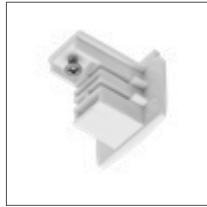

XAE-ZKUNCB-00 <WU>



XAE-LKELB-00 341



XAE-LKXUB-00 341



XAE-LKTRZWLB-00 342

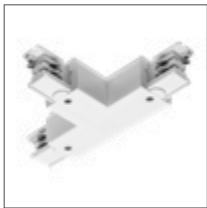

XAE-LKTWLB-00 342

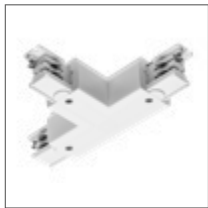

XAE-LKTZLB-00 342

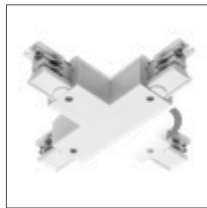

XAE-LKTRZWPB-00 343

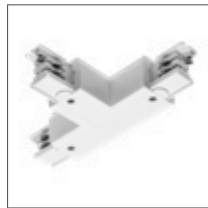

XAE-LKTWPB-00 343



XAE-LKTZPB-00 343



XAE-LELZB-00 344



XAE-LKRUB-00 344



XAE-LELUB-00 344



XAE-MSUNB-00 345



XAE-ZZWECLB-00 345



XAE-ZZWL120B-00 345



XAE-LMIZB-00 346



XAE-MSEZB-00 346



XAE-MS120B-00 346



XAE-BNADB-00 347



XAE-HMKB-00 347



XAE-GNSCH-00 347



Osprzęt elektroinstalacyjny
Installation fittings
Электроустановочные изделия
Електромонтажні вироби

CR-CR1000-10 360	CR-CR2000-10 360	CR-CR3000-10 361	CR-CR3M00-10 361	CR-CR4L00-00 362	CR-CR5000-00 362
CR-CR5M00-00 363	CR-CR6000-00 363	CR-CR7000-00 364	CR-CR8000-00 364	CR-CR9000-10 365	CR-CR9M00-10 365
CR-CO1000-00 366	CR-CO2000-00 366	CR-CR1100-00 367	CR-CR1200-00 367	CR-CR13000-00 368	CR-CR1400-00 368
CR-CR15000-00 369	CR-CR16000-00 369	CR-CR17000-00 370	CR-CR18000-00 370	CR-CR19000-00 371	AE-CM1000-00 371
AE-CM3000-00 372	AE-CM3M00-00 372	AE-CM4000-00 373	AE-CM5000-00 373	AE-CM6000-00 374	AE-CM9000-10 375
AE-CM1500-00 375	AE-SRC812-MIN 376	AE-SRC812-MIN2 376	AE-SRC812-00 377	CZ-CZ1000-00 377	CZ-CZ2000-00 378



PC-MECH24-00 379



PC-ELE724-00 379



AE-PS3G3M-00 380



AE-PF3G1M-00 380



AE-SBEBEN-30 381



AE-PFBEBEN-20 381



AE-POGRODUN-10 382



GZ-GZ10-0000 382



GZ-G90000-00 383



AE-RU0121-00 383



AE-RU0102-00 383



AE-SC0102-00 384



AE-SC0103-00 384



AE-VA1UNI-00 384



AE-RU0103-00 385



AE-OCEF27-00 385



AE-OCEE14-00 385



AE-OCEE27-00 386



AE-OCEE27-MM 386



AE-OCEE40-00 386



AE-OPE27P-00 387



GZ-E27000-10 387



AE-E14GU10-00 387



AE-E14E27-00 388



AE-E27E14-00 388



AE-27GU10-00 388



AE-GU10E27-00 389



AE-E40E27-00 389



AE-E27RING-10 389



WZL-2 390



WZL-3 390



WZL-4 390



LZ-KOI2KO-10 391



LZ-25MM00-00 391



NEW

AE-MA8025-10 392



AE-MAS80X80-10 392



AE-CANOPY-10 393



OH-ST2500-23 393



LD-KABE2M-00 394



KB-W310HUG-20 394



OS-STA422-00 394



OS-SEL236-ZHQ 395



OS-NSEL258-00 395



BK-PUL030A-0700AD 396



BK-BHL050-1000BZ 396



OA-MALEDPAN-00 397



Oświetlenie meblowe / profile led

Furniture lighting / led profiles

Освещение мебели / профили для светодиодных лент

Освітлення меблів / профіль для світлодіодної стрічки



LD-3528-300-20-ZB 404



LD-3528-300-20-ZB 406



LD-2835-24V-300-20 407



LD-ZL5RGB150-00 407



LD-COB12V-20-ZB 408



LD-COB24V-20-ZBN 408



LD-NF12V6x12-65 409



PA-GLAXGKL3M-00C 410



PA-GLAXGKS3M-00C 412



PA-GLAXGKW3M 414



PA-GLAXGKWK3M 416



PA-GLAXGKZK3M 417



PA-GLAXMICNK-AL 418



PA-GLAXMNK-AL 420



PA-GLAXNK-AL 421



PA-GLAXMNKW-AL 422



PA-GLAXMIC-AL 423



PA-GLAX-AL 424



PA-GLAXMW-AL 425



PA-GLAXDR-AL 426



PA-GLAXRAD-AL 427



PA-GLAXWN-AL 428



PA-GLAXNKKT-AL 429



PA-GLAXMNBW3M 430



PA-GLAXMNBW3M16 430



PA-GLAXMPK-AL 431



PA-GLAXREGI-AL 431



PA-GLAXNB2M16 432



PA-GLAXNBW3M16 432



PA-GLAXNBD3M16 433



PA-GLAXNBDW3M16 433



NEW

PA-GLAXKT-AL 434

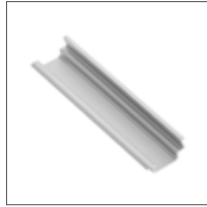

PA-GLAXWPKT-AL 434



NEW

PA-ZGLAXOMZ-00 435



NEW

PA-ZGLAXMNMOMZ 435



NEW

PA-ZGLAXKTOMZ 436



NEW

PA-ZGLAXKTOMZ 436



LD-VA24CB-53 439



LD-LU16CB-53 439



LD-CS36CB-53 440



LD-AL24CB-53 440



LD-VE15CB-53N 441



LD-VE15CBZB-53N 441



LD-TR24CB-53 442



LD-Z3CSCB-53 442



LD-OBP27CB-53 443



LD-KWP27CB-53 443



LD-RA60CB-40N 444



LD-IRUSB-53 444



LD-BOS1CBWG-53 445



LD-KLPCB-00N 445



LD-3SKL-CBN 445



LD-ZAS09WEC-30 447



LD-ZAS75W-30 448



NEW

LD-ZAS24PRO80W-30 448



LD-ZZAS07PROKD6 449



LD-ZASPRO07W-30 449



LD-ZAS150-NW 450



LD-ZAS350-NW 450



LD-WZA20W-NW 451



LD-ZASPU15W-30N 451



LD-ZSKL15-00N 452



LD-ZWND6W-10 452



LD-ZAC6WDE-RGB 453



LD-KONMINI-RGB 453



LD-KONML-MONO 454

LD-KONML-MONO-PIL 454	LD-KONML-MONO-PAN 454	LD-KONML-RGBW 455	LD-KONML-RGBW-PIL 455	LD-KONML-WRGB-PAN 455	LD-KONML-WIFI 456
LD-KONML-AD 456	AE-WDBP1-10 458	AE-WDBP2CCT-10 458	AE-WBEZDC-10S 460	AE-WBEZDK15-10 460	AE-WBEZDPIR-10 461
AE-WBEZDPIR2-20 461	AE-WBBUNI-10DIM 462	AE-WBE1-20 462	AE-WBE2-20 463	AE-WDSB-10DIM 463	AE-WBEZD-NBN 464
AE-WPDRW-00 464	AE-WLPR-60 465	AE-WLB01-10 465	AE-WLIP44-15 466	LD-DIMLED-10 466	AE-WLLAN1-10 467
AE-WLSZ1-10 467	LD-KABE2M-00 468	LZ-KA2MM-10 468	LZ-KAPR2M-10 469	LZ-AKZ312-10N 469	LZ-AKZ612-10N 470
LD-ZTK8-COB 470	LD-ZTL8MM-02N600 471	LD-ZTKT8MM-02N 471	LD-ZTK8MM-02N 472	LD-ZTLS8MMAMP-02N 472	LD-ZTKS8MM-02N 472
AE-ZLADLUX-40 473	AE-ZLADPOD-20 473	AE-ZUSB-20 474	AE-PB2FPRES-20 476	AE-BPW1FACP-10 478	AE-BPW4F120P-10 480



AE-BPW2FCAM-20 482



AE-PB1FAVAP-20 484



AE-PB1FAVA-20 486



AE-BPW1S2UCH-80 488



AE-BPW1U1UCH-53 488



AE-BPW1U1UCH-51 489



AE-BPW4U100-53 489



AE-BPW3GU-20 490



AE-BPW3U60-20 490



AE-PB03GS-53 491



AE-PBU02GS-10 491



AE-PBSC3GS-10 492



AE-PBC3GS-53BKS 494



AE-PBC3GS-51BK 494



AE-PBKT4U-80 495



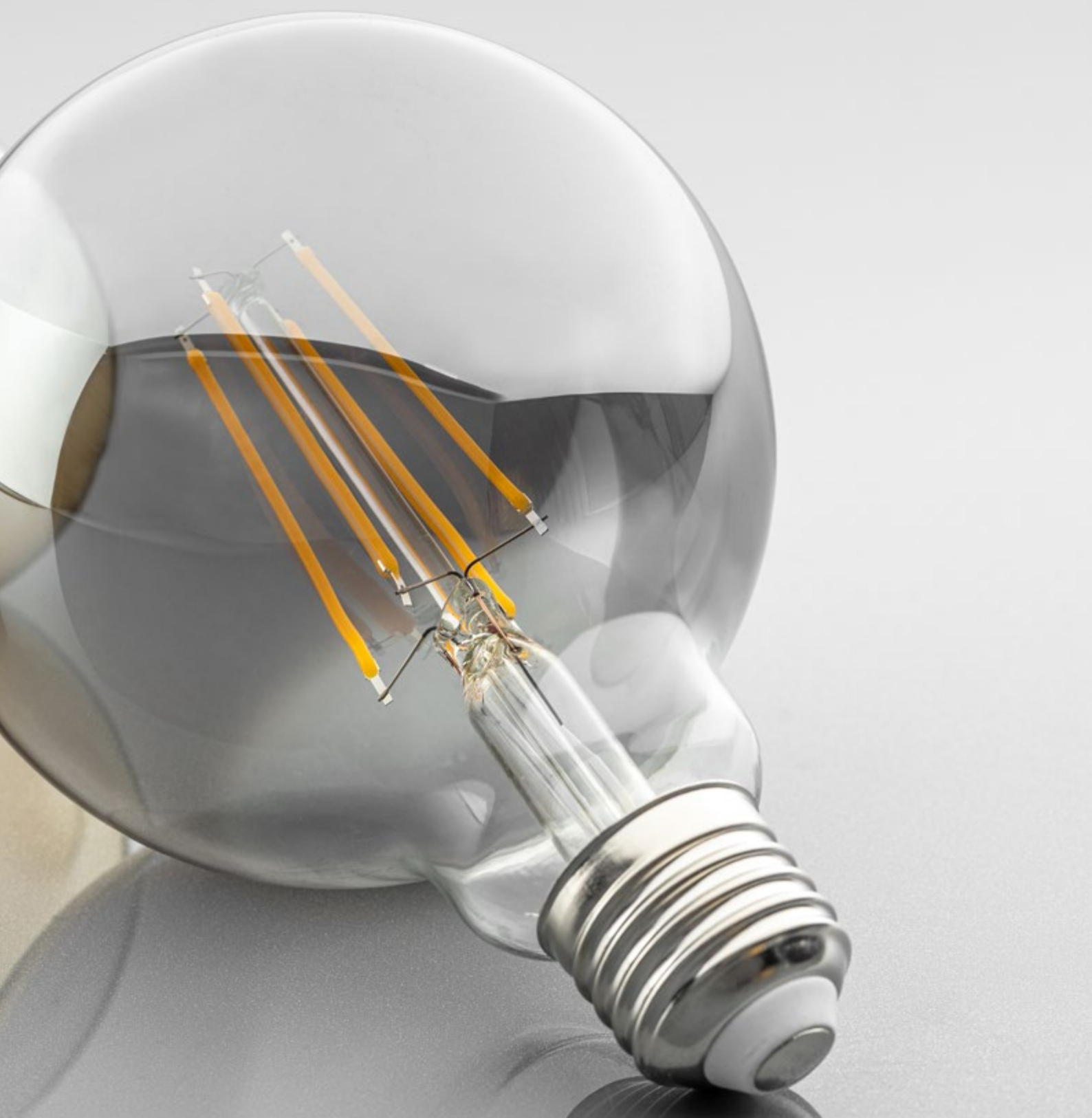

ŹRÓDŁA ŚWIATŁA
LIGHT SOURCES
ИСТОЧНИКИ СВЕТА
ДЖЕРЕЛА СВІТЛА



Źródła Światła LED	
LED light sources	
Светодиодные источники света	
Світлодіодні джерела світла	25
Świetlówki LED typu T8	
LED light sources T8	
Светодиодные лампы типа T8	
Світлодіодні лампи типу T8	60



ŹRÓDŁA ŚWIATŁA LED
LED LIGHT SOURCES
СВЕТОДИОДНЫЕ ИСТОЧНИКИ СВЕТА
СВІТЛОДІОДНІ ДЖЕРЕЛА СВІТЛА

**GTV**
LIGHTING

PL Źródło światła LED
 EN LED light source
 RU Светодиодный источник света
 UK Світлодіодне джерело світла

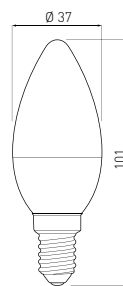
C30**NEW****LED**
TECHNOLOGY**3**
years
warranty**E14**

3-6 W



LD-SMGC30B-30	3,0 W	3,0 W = 26 W	F	33 mA	● 3000 K	260 lm	PF > 0,4	32 g	5901867120014
LD-SMNGC30B-30					● 4000 K				5902801235139
LD-SMZGC30B-30					● 6400 K				5902801414725
LD-SMGC30B-60*	6,0 W	6,0 W = 43 W		52 mA	● 3000 K	520 lm	PF > 0,5		5901867171948
LD-SMNGC30B-60*					● 4000 K				5902801235344
LD-SMZGC30B-60*					● 6400 K				5902801423765

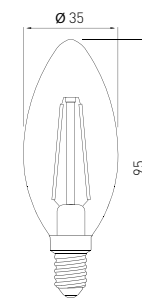

PL Źródło światła LED
 EN LED light source
 RU Светодиодный источник света
 UK Світлодіодне джерело світла

C35**NEW****LED**
TECHNOLOGY**3**
years
warranty**E14**

4 W



LD-C35FLE4M-30	4,0 W	4,0 W = 37 W	F	44 mA	● 3000 K	420 lm	30 g	5902801339400
LD-C35FLE4M-40				37 mA	● 4000 K			5902801358326

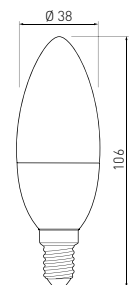

PL Źródło światła LED
 EN LED light source
 RU Светодиодный источник света
 UK Світлодіодне джерело світла

C37**NEW****LED**
TECHNOLOGY**3**
years
warranty**E14**

8 W



LD-SMDC37-80	8,0 W	8,0 W = 55 W	F	70 mA	● 3000 K	720 lm	30 g	5902801028373
LD-SMND37-80					● 4000 K			5902801298967
LD-SMZDC37-80					● 6400 K			5902801424243



PL Źródło światła LED
EN LED light source
RU Светодиодный источник света
UK Світлодіодне джерело світла

C30L

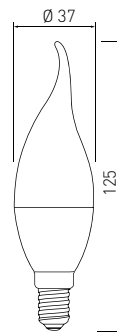

NEW

3
years
warranty

LED
certified

E14

6 W



LD-SMGC30L-30	3,0 W	3,0 W = 26 W	F	33 mA	● 3000 K	260 lm	35 g	5902801423529
LD-SMNGC30L-30					● 4000 K			5902801423550
LD-SMZGC30L-30					● 6400 K			5902801423604
LD-SMGC30L-60	6,0W	6,0 W = 43 W		52 mA	● 3000 K	520 lm		5901867120359
LD-SMNGC30L-60					● 4000 K			5902801235016
LD-SMZGC30L-60					● 6400 K			5902801423826



PL Źródło światła LED
EN LED light source
RU Светодиодный источник света
UK Світлодіодне джерело світла

C37L

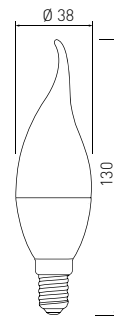

3
years
warranty

LED
certified

E14

8 W



LD-SMC37L-80	8,0 W	8,0 W = 55 W	F	70 mA	● 3000 K	720 lm	30 g	5902801028380
LD-SMNC37L-80					● 4000 K			5902801298899
LD-SMZC37L-80					● 6400 K			5902801425028



PL Źródło światła LED
EN LED light source
RU Светодиодный источник света
UK Світлодіодне джерело світла

C35L

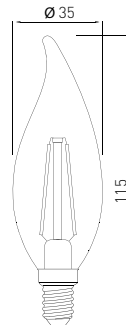

NEW

3
years
warranty

LED
certified

E14

4 W



LD-C35FLE4M-30L	4,0 W	4,0 W = 37 W	F	44 mA	● 3000 K	420 lm	30 g	5902801339424
LD-C35FLE4M-40L					● 4000 K			420 lm



**GTV**
LIGHTING

PL Źródło światła LED
 EN LED light source
 RU Светодиодный источник света
 UK Світлодіодне джерело світла

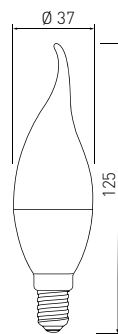
**NEW**3 years
warranty**LED**
TECHNOLOGY**E14**

8 W



LD-SMC37L-10	10,0 W	72,0 W	F	1000 lm	3000 K	80mA	62g	46	130,5	5902801362262
LD-SMNC37L-10					4000 K					5902801362606

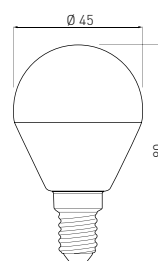

PL Źródło światła LED
 EN LED light source
 RU Светодиодный источник света
 UK Світлодіодне джерело світла

B45**NEW**3 years
warranty**LED**
TECHNOLOGY**E14**

3-6 W



LD-SMGB45B-30	3,0 W	3,0 W = 25 W	F	33 mA	3000 K	225 lm	PF > 0,4	35 g	5901867120410
LD-SMNGB45B-30					4000 K				5902801235481
LD-SMZGB45B-30					6400 K				5902801423642
LD-SMGB45B-60*	6,0 W	6,0 W = 43 W	F	52 mA	3000 K	520 lm	PF > 0,5	35 g	5901867120465
LD-SMNGB45B-60*					4000 K				5902801234941
LD-SMZGB45B-60*					6400 K				5902801423888

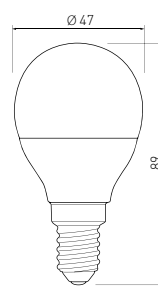

PL Źródło światła LED
 EN LED light source
 RU Светодиодный источник света
 UK Світлодіодне джерело світла

B45**NEW**3 years
warranty**LED**
TECHNOLOGY**E14**

8 W



LD-SMB45B-80	8,0 W	8,0 W = 55 W	F	70 mA	3000 K	720 lm	30 g	5902801028397
LD-SMNB45B-80					4000 K			5902801298929
LD-SMZBD45-80					6400 K			5902801476921



PL Źródło światła LED
EN LED light source
RU Светодиодный источник света
UK Світлодіодне джерело світла

G45

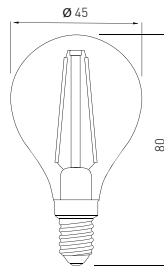

NEW

LED
technology

3
years
warranty

E14
4 W

Light sources

LD-G45FLE4M-30	4,0 W	4,0 W = 37 W	F	44 mA	● 3000 K	420 lm	30 g	5902801339301
LD-G45FLE4M-40					● 4000 K			5902801358098



PL Źródło światła LED
EN LED light source
RU Светодиодный источник света
UK Світлодіодне джерело світла

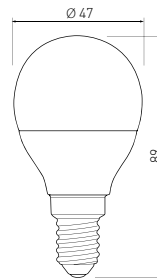

NEW

LED
technology

3
years
warranty

E14
10 W

LD-SMB45B-10	10,0 W	10,0 W = 72 W	F	80 mA	● 3000 K	1000 lm	69 g	5902801362378
LD-SMNB45B-10					● 4000 K			5902801362590





PL Źródło światła LED
EN LED light source
RU Светодиодный источник света
UK Світлодіодне джерело світла

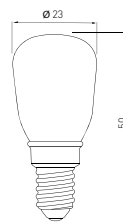

LED



E14

2 W

LD-E14S2WE0-40	2,0 W	2,0 W = 19 W	F	22 mA	4000 K	180 lm	10 g	5902801328893



PL Źródło światła LED
EN LED light source
RU Светодиодный источник света
UK Світлодіодне джерело світла

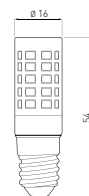

LED



E14

3,5 W

LD-E14P35WE-30	3,5 W	3,5 W = 32 W	F	38 mA	3000 K	350 lm	12 g	5902801330681



PL Źródło światła LED
EN LED light source
RU Светодиодный источник света
UK Світлодіодне джерело світла

R50

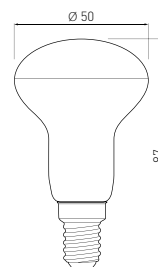

LED



E14

6 W

LD-R5060W-30	6,0 W	6,0 W = 43 W	F	52 mA	3000 K	520 lm	28 g	5901867113467
LD-R5060W-40		6,0 W = 42 W			4000 K	500 lm		5902801215872



PL Źródło światła LED
EN LED light source
RU Светодиодный источник света
UK Світлодіодне джерело світла

C35

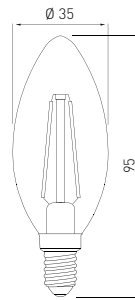

NEW

3
years
warranty

LED
LIGHT SOURCE

E14
4 W

Light sources



LD-C35FLE4-30	4,0 W	4,0 W = 37 W	F	44 mA	● 3000 K	420 lm	30 g	5902801328831
LD-C35FLE4-40					● 4000 K			5902801339325



PL Źródło światła LED
EN LED light source
RU Светодиодный источник света
UK Світлодіодне джерело світла

C35L

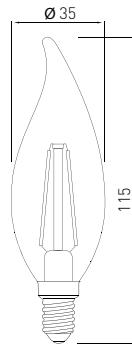

NEW

3
years
warranty

LED
LIGHT SOURCE

E14
4 W



LD-C35FLE4-30L	4,0 W	4,0 W = 37 W	F	44 mA	● 3000 K	420 lm	30 g	5902801328268
LD-C35FLE4-40L					● 4000 K			5902801339448



PL Źródło światła LED
EN LED light source
RU Светодиодный источник света
UK Світлодіодне джерело світла

G45

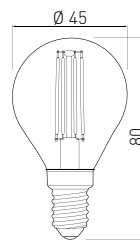

NEW

3
years
warranty

LED
LIGHT SOURCE

E14
4 W



LD-G45FLE4-30	4,0 W	4,0 W = 37 W	F	44 mA	● 3000 K	420 lm	30 g	5902801328435
LD-G45FLE4-40					● 4000 K			5902801356933



**GTV**
LIGHTING

PL Źródło światła LED
 EN LED light source
 RU Светодиодный источник света
 UK Світлодіодне джерело світла

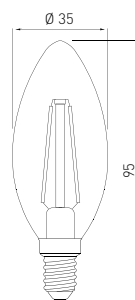
C35**NEW****3**
years
warranty**LED**
TECHNOLOGY**E14**

4 W



LD-C35FP4-18	4,0 W	4,0 W = 21 W	-	44 mA	1800 K	200 lm	30 g	5902801393228
LD-C35FEP4-30		4,0 W = 28 W	G		2700 K	300 lm		5902801359071

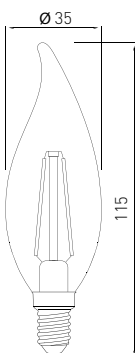

PL Źródło światła LED
 EN LED light source
 RU Светодиодный источник света
 UK Світлодіодне джерело світла

C35L**NEW****3**
years
warranty**LED**
TECHNOLOGY**E14**

4 W



LD-C35FP4-18L	4,0 W	4,0 W = 21 W	-	44 mA	1800 K	200 lm	30 g	5902801397707
LD-C35FEP4-30L		4,0 W = 28 W	G		2700 K	300 lm		5902801359217

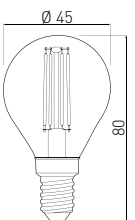

PL Źródło światła LED
 EN LED light source
 RU Светодиодный источник света
 UK Світлодіодне джерело світла

G45**NEW****3**
years
warranty**LED**
TECHNOLOGY**E14**

4 W



LD-G45FP4-18	4,0 W	4,0 W = 21 W	-	44 mA	1800 K	200 lm	30 g	5902801393464
LD-G45FPE4-30		4,0 W = 28 W	G		2700 K	300 lm		5902801358500



PL Źródło światła LED
EN LED light source
RU Светодиодный источник света
UK Світлодіодне джерело світла

A60

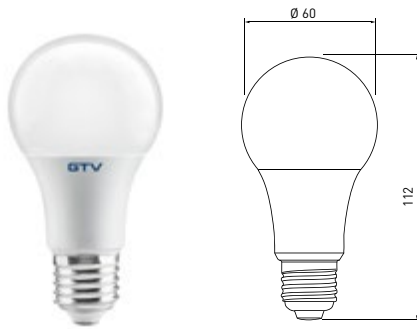

LD-PC2A60-8W	8,0 W	8,0 W = 55 W	F	70 mA	3000 K	720 lm	40 g	5902801216305
LD-PN2A60-8W					4000 K			5902801216312

PL Źródło światła LED
EN LED light source
RU Светодиодный источник света
UK Світлодіодне джерело світла

A60



LD-PC3A60-10W	9,5 W	9,5 W = 66 W	F	83 mA	3000 K	900 lm	40 g	5901867153302
LD-PN3A60-10W					4000 K			5902801000508
LD-PZ3A60-10W					6400 K			5902801269639

PL Źródło światła LED
EN LED light source
RU Светодиодный источник света
UK Світлодіодне джерело світла

A60

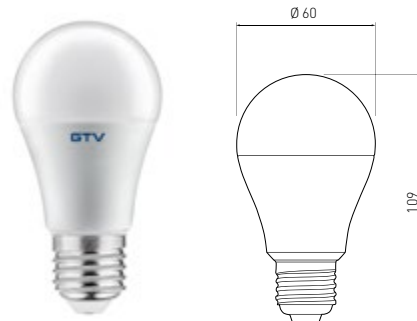

LD-PC2A60-12	11,5 W	11,5 W = 77 W	F	100 mA	3000 K	1100 lm	45 g	5901867131621
LD-PN2A60-12					4000 K			5902801000539
LD-PZ2A60-12					6400 K			5902801269646



PL Źródło światła LED
EN LED light source
RU Светодиодный источник света
UK Світлодіодне джерело світла

A60

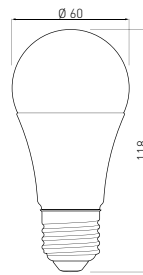
LED
LIGHTING

E27

14 W



LD-PC3A60-15W	14,1 W	14,1 W = 94 W	F	123 mA	3000 K	1400 lm	45 g	5901867124838
LD-PN3A60-15W					4000 K			5902801000560
LD-PZ3A60-15W					6400 K			5902801341885



PL Źródło światła LED
EN LED light source
RU Светодиодный источник света
UK Світлодіодне джерело світла

A60

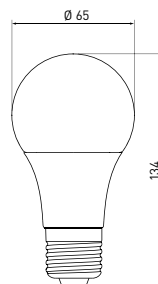
LED
LIGHTING

E27

17 W



LD-PC3A65-18W	17,3 W	17,3 W = 112 W	F	150 mA	3000 K	1750 lm	54 g	5902801233951
LD-PN3A65-18W					4000 K			5902801234187
LD-PZ3A65-18W					6400 K			5902801340055

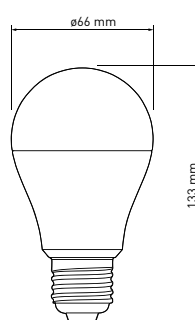

PL Źródło światła LED
EN LED light source
RU Светодиодный источник света
UK Світлодіодне джерело світла

LED
LIGHTING

E27

20 W



LD-PC4A65-20W	20,0 W	20,0 W = 148 W	E	164 mA	3000 K	2400 lm	PF > 0,5	65 g	5902801398667
LD-PN4A65-20W					4000 K				5902801398681
LD-PZ4A65-20W					6500 K				5902801398414



PL Źródło światła LED
EN LED light source
RU Светодиодный источник света
UK Світлодіодне джерело світла

A60

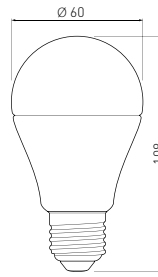

LED



6 W



LD-PC2A60-6W	6,0 W	6,0 W = 43 W	F	52 mA	3000 K	520 lm	60 g	5901867118745
--------------	-------	--------------	---	-------	--------	--------	------	---------------



PL Źródło światła LED
EN LED light source
RU Светодиодный источник света
UK Світлодіодне джерело світла

A60

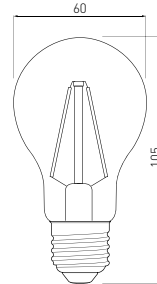

LED



8 W



LD-A60FLE8M-30	8,0 W	8,0 W = 60 W	F	70 mA	3000 K	800 lm	60 g	5902801339332
LD-A60FLE8M-40					4000 K			5902801351006



PL Źródło światła LED
EN LED light source
RU Светодиодный источник света
UK Світлодіодне джерело світла

R63

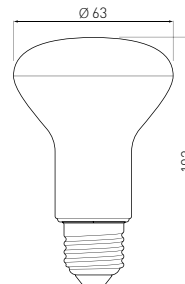

LED



8 W



LD-R6380W-30	7,8 W	7,8 W = 54 W	F	68 mA	3000 K	700 lm	51 g	5901867113436
LD-R6380W-40					4000 K			5902801215711





PL Źródło światła LED
EN LED light source
RU Светодиодный источник света
UK Світлодіодне джерело світла

A60



LED



10 W



LD-PC2A60RGBW-10W	10,0 W	10,0 W = 60 W	F	87 mA	RGBW	810 lm	135 g	5902801285080



PL Źródło światła LED
EN LED light source
RU Светодиодный источник света
UK Світлодіодне джерело світла

A60



LED



9 W

LD-A60CZ3-10W	9,3 W	9,3 W = 61 W	F	81 mA	3000 K	820 lm	40 g	5902801074257
LD-A60CZ4-10W					4000 K			5902801074233



PL Źródło światła LED
EN LED light source
RU Светодиодный источник света
UK Світлодіодне джерело світла

A60



LED



9 W

LD-A60CM3-10W	9,1 W	9,1 W = 61 W	F	79 mA	3000 K	820 lm	40 g	5902801073342
LD-A60CM4-10W					4000 K			5902801073335





PL Źródło światła LED
EN LED light source
RU Светодиодный источник света
UK Світлодіодне джерело світла

A60

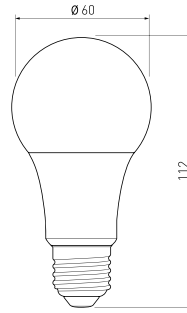

LED

E27

10 W



LD-SPCA60-10W	10,0 W	10,0 W = 68 W	F	87 mA	● 3000 K	940 lm	90 g	5902801294877
LD-SPNA60-10W					● 4000 K			5902801294938



PL Źródło światła LED
EN LED light source
RU Светодиодный источник света
UK Світлодіодне джерело світла

A60

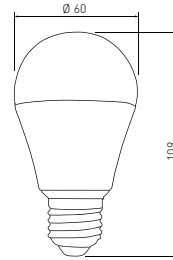

LED

E27

12 W



LD-DC24A60-12	12,0 W	12,0 W = 75 W	G	● 3000 K	1055 lm	50 g	5902801270925
---------------	--------	---------------	---	----------	---------	------	---------------



PL Źródło światła LED
EN LED light source
RU Светодиодный источник света
UK Світлодіодне джерело світла

C30

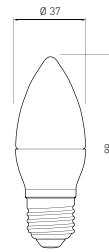

LED

E27

3 - 6 W



LD-SMGC30C-30	3,0 W	3,0 W = 26 W	F	33 mA	● 3000 K	260 lm	35 g	5902801417818
LD-SMNGC30C-30					● 4000 K			5902801416071
LD-SMZGC30C-30					● 6400 K			5902801423185
LD-SMGC30C-60	6,0 W	6,0 W = 43 W		52 mA	● 3000 K	520 lm		5901867120175
LD-SMNGC30C-60					● 4000 K			5902801235061
LD-SMZGC30C-60					● 6400 K			5902801423734





PL Źródło światła LED
EN LED light source
RU Светодиодный источник света
UK Світлодіодне джерело світла

B45

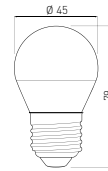

6 W



LD-SMGB45C-30	3,0 W	3,0 W = 25 W	F	33 mA	3000 K	255 lm	37 g	5902801423727
LD-SMNGB45C-30					4000 K			5902801423680
LD-SMZGB45C-30					6400 K			5902801423772
LD-SMGB45C-60	6,0 W	6,0 W = 43 W		52 mA	3000 K	520 lm		5901867120519
LD-SMNGB45C-60					4000 K			5902801235030
LD-SMZGB45C-60					6400 K			5902801423895



PL Źródło światła LED
EN LED light source
RU Светодиодный источник света
UK Світлодіодне джерело світла

B45

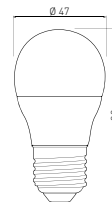

8 W



LD-SMBD45-80	8,0 W	8,0 W = 55 W	F	70 mA	3000 K	720 lm	30 g	5902801028403
LD-SMNBD45-80					4000 K			5902801298868



PL Źródło światła LED
EN LED light source
RU Светодиодный источник света
UK Світлодіодне джерело світла

G45

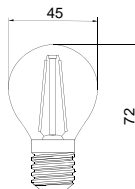

2-4 W



LD-G45FLE2EM-30	2,0 W	2,0 W = 21 W	F	22 mA	3000 K	200 lm	13 g	5902801339387
LD-G45FLE4E-30	4,0 W	4,0 W = 37 W		44 mA		420 lm		5902801339240





PL Źródło światła LED
EN LED light source
RU Светодиодный источник света
UK Світлодіодне джерело світла

G45

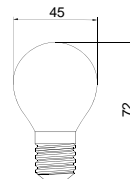

NEW

3
years
warranty

LED

E27

2-4 W

LD-G45FLE2EM-40	2,0 W	2,0 W = 21 W	F	22 mA	● 4000 K	200 lm	13 g	5902801358388
LD-G45FLE4EM-40	4,0 W	4,0 W = 37 W		44 mA		420 lm		5902801359095



PL Źródło światła LED
EN LED light source
RU Светодиодный источник света
UK Світлодіодне джерело світла

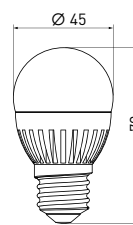

NEW

3
years
warranty

LED

E27

10 W

LD-SMBD45-10	10,0 W	10,9 W = 72 W	F	1000 lm	● 3000 K	80 mA	69 g	5902801362330
LD-SMNB45-10				● 4000 K	5902801361968			



PL Źródło światła LED
EN LED light source
RU Светодиодный источник света
UK Світлодіодне джерело світла

G120

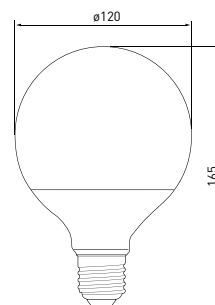
3
years
warranty

LED

E27

14-18 W

LD-120G14W-32	14,0 W	14,0 W = 92 W	F	122 mA	● 3000 K	1380 lm	107 g	5901867169242
LD-120G14W-40				● 4000 K	5902801299230			
LD-120G18W-32	18,0 W	18,0 W = 116 W		157 mA	● 3000 K	1820 lm	155 g	5901867169259
LD-120G18W-40				● 4000 K	5902801299278			



PL Źródło światła LED
EN LED light source
RU Светодиодный источник света
UK Світлодіодне джерело світла

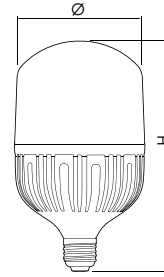

LD-ALF100-27W	27,0W	27,0 W = 172 W	E27	F	131 mA	● 4000 K	2900 lm	96	185	183 g	5902801374890
LD-ALF120-34W	34,0W	-			165 mA		3700 lm	115	207	248 g	5902801374883
LD-ALF140-43W	43,0W	-	E40		208 mA		4600 lm	149	245	353 g	5902801331510



**GTV**
LIGHTING

PL Źródło światła LED
 EN LED light source
 RU Светодиодный источник света
 UK Світлодіодне джерело світла

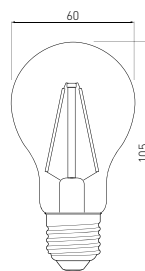
A60**NEW****3**
years
warranty**LED**
LIGHTING**E27****8 W**

LD-A60FLE8-30	8,0 W	8,0 W = 64 W	E	70 mA	● 3000 K	880 lm	34 g	5902801328770
LD-A60FLE8-40					● 4000 K			5902801356407

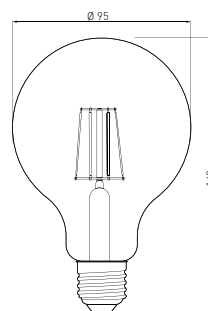

PL Źródło światła LED
 EN LED light source
 RU Светодиодный источник света
 UK Світлодіодне джерело світла

G95**NEW****3**
years
warranty**LED**
LIGHTING**E27****8 W**

LD-G95FLE8-30	8,0 W	8,0 W = 64 W	E	70 mA	● 3000 K	880 lm	100 g	5902801328800
LD-G95FLE8-40					● 4000 K			5902801339394

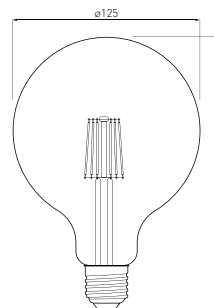

PL Źródło światła LED
 EN LED light source
 RU Светодиодный источник света
 UK Світлодіодне джерело світла

G125**NEW****3**
years
warranty**LED**
LIGHTING**E27****8 W**

LD-G125FLE8-30	8,0 W	8,0 W = 64 W	E	70 mA	● 3000 K	880 lm	200 g	5902801338465
LD-G125FLE8-40					● 4000 K			5902801358333



PL Źródło światła LED
 EN LED light source
 RU Светодиодный источник света
 UK Світлодіодне джерело світла

ST64

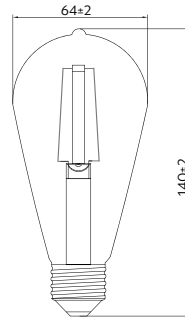

NEW

LED
LIGHT SOURCE

3
years
warranty



E27

6 W

Light sources



LD-ST64FLE6-30	6,0 W	6,0 W = 48 W	F	52 mA	● 3000 K	600 lm	46 g	5902801358395
LD-ST64FLE6-40					● 4000 K			5902801339431



PL Źródło światła LED
EN LED light source
RU Светодиодный источник света
UK Світлодіодне джерело світла

ST64

360°

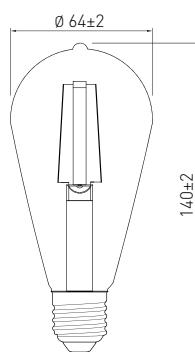
NEW
LED
LIGHTING

4 W



LD-ST64FVE4-30	4,0 W	4,0 W = 28 W	G	44 mA	3000 K	300 lm	46 g	5902801339196
----------------	-------	--------------	---	-------	--------	--------	------	---------------



PL Źródło światła LED
EN LED light source
RU Светодиодный источник света
UK Світлодіодне джерело світла

G95

360°

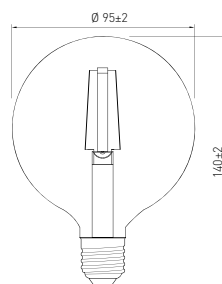
NEW
LED
LIGHTING

4 W



LD-G95FEV4-30	4,0 W	4,0 W = 28 W	G	44 mA	3000 K	300 lm	56 g	5902801339295
---------------	-------	--------------	---	-------	--------	--------	------	---------------



PL Źródło światła LED
EN LED light source
RU Светодиодный источник света
UK Світлодіодне джерело світла

G125

360°

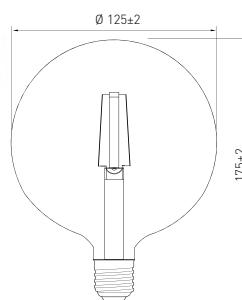
NEW
LED
LIGHTING

4 W



LD-G125FEV4-30	4,0 W	4,0 W = 28 W	G	44 mA	3000 K	300 lm	100 g	5902801339288
----------------	-------	--------------	---	-------	--------	--------	-------	---------------







PL Źródło światła LED
EN LED light source
RU Светодиодный источник света
UK Світлодіодне джерело світла



A60

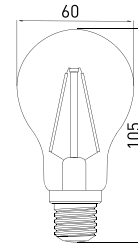

LD-A60FP8-18	8,0 W	8,0 W = 35 W	-	70 mA	1800 K	400 lm	75 g	5902801393419
LD-A60FPE8-30		8,0 W = 55 W	F		2700 K	720 lm		5902801358517



PL Źródło światła LED
EN LED light source
RU Светодиодный источник света
UK Світлодіодне джерело світла

G95

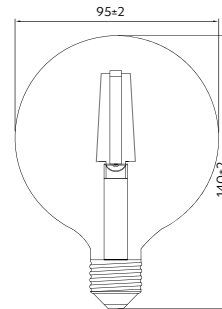

LD-G95FP8-18	8,0 W	8,0 W = 39 W	-	70 mA	1800 K	450 lm	150 g	5902801393358
LD-G95FPE8-30		8,0 W = 55 W	F		2700 K	720 lm		5902801328800



PL Źródło światła LED
EN LED light source
RU Светодиодный источник света
UK Світлодіодне джерело світла

G125

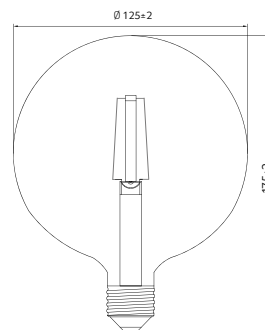

LD-G125FP8-18	8,0 W	8,0 W = 39 W	-	70 mA	1800 K	450 lm	250 g	5902801398100
LD-G125FPE8-30		8,0 W = 55 W	F		2700 K	720 lm		5902801359293



PL Źródło światła LED
EN LED light source
RU Светодиодный источник света
UK Світлодіодне джерело світла

ST64

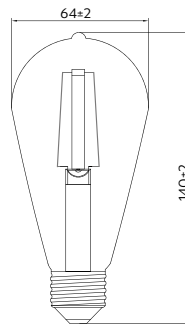

NEW

LED
LIGHT SOURCE

3
years
warranty



6 W

Light sources



LD-ST64FP4-18	6,0 W	6,0 W = 28,0 W	-	43 mA	● 1800 K	300 lm	45 g	5902801370526
LD-ST64FPE6-30		6,0 W = 42 W	F	52 mA	● 2700 K	500 lm	46 g	5902801359255





PL Źródło światła LED
EN LED light source
RU Светодиодный источник света
UK Світлодіодне джерело світла

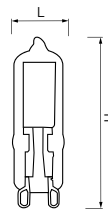

NEW

LED
LIGHT SOURCE3
years
warranty

G9

3-4 W



LD-G93WE25-30	2,5 W	2,5 W = 25 W	F	27 mA	● 3000 K	250 lm	14 x 48	7 g	5902801339455
LD-G93WE25-40					● 4000 K				5902801339158
LD-G935W04-30	3,5 W	3,5 W = 32 W	F	38 mA	● 3000 K	350 lm	13,4 x 60	9 g	5902801359231
LD-G935W04-40					● 4000 K				5902801351457

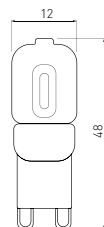

PL Źródło światła LED
EN LED light source
RU Светодиодный источник света
UK Світлодіодне джерело світла

3
years
warrantyLED
LIGHT SOURCE

G9

3 W



LD-G93W25-32	2,5 W	2,5 W = 22 W	F	27 mA	● 3000 K	220 lm	40 g	5902801328336
LD-G93W25-45					● 4000 K			5902801328640

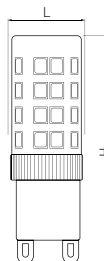

PL Źródło światła LED
EN LED light source
RU Светодиодный источник света
UK Світлодіодне джерело світла

3
years
warrantyLED
LIGHT SOURCE

G9

4-5 W



LD-G9PE35W-30	3,5 W	3,5 W = 32 W	F	38 mA	● 3000 K	350 lm	15 x 50	12 g	5902801328312
LD-G9PE35W-40					● 4000 K				5902801328695
LD-G9P5WE0-30	5,0 W	5,0 W = 35 W	G	54 mA	● 3000 K	400 lm	15 x 54,5	14 g	5902801328879
LD-G9P5WE0-40					● 4000 K				5902801338496



PL Źródło światła LED
EN LED light source
RU Светодиодный источник света
UK Світлодіодне джерело світла

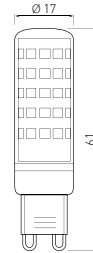

LD-G9P67W0-30	6,5 W	6,5 W = 48 W	F	57 mA	● 3000 K	600 lm	18 g	5902801339141
LD-G9P67W0-40					● 4000 K			5902801338540



PL Źródło światła LED
EN LED light source
RU Светодиодный источник света
UK Світлодіодне джерело світла

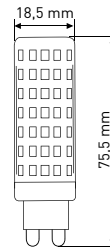

LD-G9P95W0-30	9,5 W	9,5 W = 66 W	F	83 mA	● 3000 K	900 lm	200 g	5902801351617
LD-G9P95W0-40					● 4000 K			5902801351464



PL Źródło światła LED
EN LED light source
RU Светодиодный источник света
UK Світлодіодне джерело світла

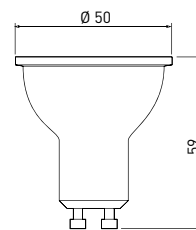

LD-SPCGU10-7W	7,0 W	7,0 W = 48 W	F	61 mA	● 3000 K	600 lm	70 g	5902801295010
LD-SPNGU10-7W					● 4000 K			5902801295010



**GTV**
LIGHTING

PL Źródło światła LED
 EN LED light source
 RU Светодиодный источник света
 UK Світлодіодне джерело світла

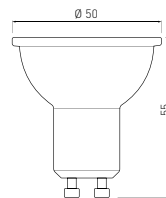
**NEW****LED**
TECHNOLOGY**3**
years
warranty**GU10**

1-4 W



LD-NGU10P-1W	1,0 W	1,0 W = 12 W	E	14 mA	3000 K	110 lm	120°	37 g	5902801407253
LD-NGU10PN-1W					4000 K				5901867194954
LD-NGU10PZ-1W					6400 K				5902801407079
LD-NGU10P-3W	2,5 W	2,5 W = 24 W	F	27 mA	3000 K	240 lm	120°	37 g	5901867131591
LD-NGU10PN-3W					4000 K				5902801299070
LD-NGU10PZ-3W					6400 K				5902801407291
LD-NGU10P-4W	3,5 W	3,5 W = 32 W	F	38 mA	3000 K	350 lm	120°	37 g	5908231395702
LD-NGU10PN-4W					4000 K				5902801299001
LD-NGU10PZ-4W					6400 K				5902801407420

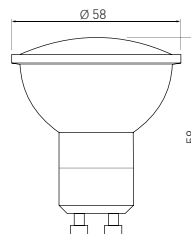

PL Źródło światła LED
 EN LED light source
 RU Светодиодный источник света
 UK Світлодіодне джерело світла

**3**
years
warranty**LED**
TECHNOLOGY**GU10**

4 W



LD-SZ1510-30	4,0 W	4,0 W = 30 W	F	43 mA	3000 K	320 lm	45 g	5901867109712
LD-SZ1510-40					4000 K			5901867109729
LD-SZ1510-64					6400 K			5901867109743

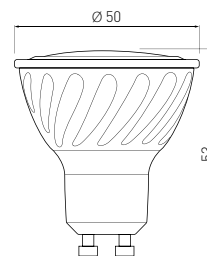

PL Źródło światła LED
 EN LED light source
 RU Светодиодный источник света
 UK Світлодіодне джерело світла

**3**
years
warranty**LED**
TECHNOLOGY**GU10**

6-7 W



LD-PC6010-30	5,6 W	5,6 W = 36 W	F	49 mA	3000 K	410 lm	52 g	5901867155436
LD-PC6010-40					4000 K			5901867198785
LD-PC6010-64					6400 K			5901867197139
LD-PC7510-30	7,0 W	7,0 W = 45 W	F	61 mA	3000 K	550 lm	52 g	5901867155405
LD-PC7510-40					4000 K			5901867198792
LD-PC7510-64					6400 K			5901867197160



PL Źródło światła LED
EN LED light source
RU Светодиодный источник света
UK Світлодіодне джерело світла



LED TECHNOLOGY

GU10

9 W

Light sources



LD-SM1210-10	9,1 W	9,1 W = 63 W	F	80 mA	3000 K	850 lm	50 g	5901867189967
LD-SM1210N-10					4000 K			5902801299513
LD-SM1210Z-10					6400 K			5902801342790



PL Źródło światła LED
EN LED light source
RU Светодиодный источник света
UK Світлодіодне джерело світла



LED TECHNOLOGY

GU10

5 W

LD-SZ5010-30	5,0 W	5,0 W = 35 W	F	54 mA	3000 K	400 lm	45 g	5901867196798
LD-SZ5010-40					4000 K			5902801000690
LD-SZ5010-64					6400 K			5901867196804



PL Źródło światła LED
EN LED light source
RU Светодиодный источник света
UK Світлодіодне джерело світла



LED TECHNOLOGY

GU10

3 - 7 W

LD-SZ30W10-30	3,0	3,0 W = 26 W	F	33 mA	3000 K	270 lm	>0,4	46g	5902801360817
LD-SZ30W10-40	3,0	3,0 W = 26 W			4000 K	270 lm	>0,4		5902801360848
LD-SZ30W10-64	3,0	3,0 W = 26 W			6400 K	270 lm	>0,4		5902801360855
LD-SZ50W10-30	5,0	5,0 W = 39 W		54 mA	3000 K	460 lm	>0,4		5902801361005
LD-SZ50W10-40	5,0	5,0 W = 39 W			4000 K	460 lm	>0,4		5902801361142
LD-SZ50W10-64	5,0	5,0 W = 39 W			6400 K	460 lm	>0,4		5902801360992
LD-SZ70W10-30	6,7	6,7 W = 52 W		58 mA	3000 K	670 lm	>0,5		5902801361180
LD-SZ70W10-40	6,7	6,7 W = 52 W			4000 K	670 lm	>0,5		5902801361531
LD-SZ70W10-64	6,7	6,7 W = 52 W			6400 K	670 lm	>0,5		5902801361043

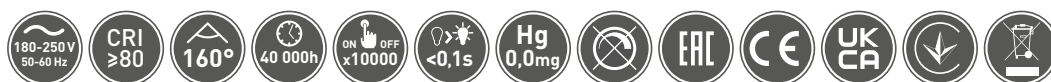



PL Źródło światła LED
EN LED light source
RU Светодиодный источник света
UK Світлодіодне джерело світла

J78

360°

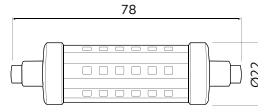
LED
TECHNOLOGY

R7s

5 W



LD-J7806WE-40

5,0 W

5,0 W = 42 W

F

54 mA

● 4000 K

500 lm

240 g

5902801339066



PL Źródło światła LED
EN LED light source
RU Светодиодный источник света
UK Світлодіодне джерело світла

J78

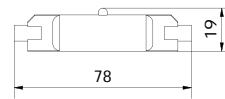
LED
TECHNOLOGY

R7s

5 W



LD-J7805WCE-40

5,0 W

5,0 W = 42 W

F

54 mA

● 4000 K

500 lm

150 g

5902801359316



PL Źródło światła LED
EN LED light source
RU Светодиодный источник света
UK Світлодіодне джерело світла

J118

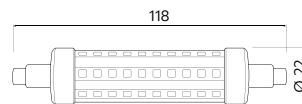
LED
TECHNOLOGY

R7s

9 W



LD-J11810WE-40

9,0 W

9,0 W = 66 W

F

78 mA

● 4000 K

900 lm

390 g

5902801339059



PL Źródło światła LED
 EN LED light source
 RU Светодиодный источник света
 UK Світлодіодне джерело світла

J118



LED
LIGHT SOURCE



R7s

9 W

Light sources



LD-J11809WCE-40	9,0 W	9,0 W = 66 W	F	78 mA	● 4000 K	900 lm	200 g	5902801351426
-----------------	-------	--------------	---	-------	----------	--------	-------	---------------





PL Źródło światła LED
EN LED light source
RU Светодиодный источник света
UK Світлодіодне джерело світла

NEW

LED
TECHNOLOGY3
years
warranty

GU10

13 W



LD-ES111WW13W40-10
LD-ES111NW13W40-10



LD-ES111WW13W40-00
LD-ES111NW13W40-00



LD-ES111WW13W40-15
LD-ES111NW13W40-15

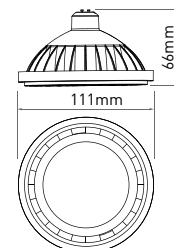

LD-ES111WW13W40-10	12,5 W	F	109 mA	3000 K	1100 lm	40°	95 g	5902801343780
LD-ES111NW13W40-10		E		4000 K	1250 lm	40°		5902801343797
LD-ES111WW13W120-10		F		3000 K	1100 lm	120°		5902801347467
LD-ES111NW13W120-10		E		4000 K	1250 lm	120°		5902801347160
LD-ES111WW13W40-00		F		3000 K	1100 lm	40°		5902801343551
LD-ES111NW13W40-00		E		4000 K	1250 lm	40°		5902801343001
LD-ES111WW13W120-00		F		3000 K	1100 lm	120°		5902801347559
LD-ES111NW13W120-00		E		4000 K	1250 lm	120°		5902801347672
LD-ES111WW13W40-15		F		3000 K	1100 lm	40°		5902801347238
LD-ES111NW13W40-15		E		4000 K	1250 lm	40°		5902801347177
LD-ES111WW13W120-15		F		3000 K	1100 lm	120°		5902801347658
LD-ES111NW13W120-15		E		4000 K	1250 lm	120°		5902801347757



PL Źródło światła LED
EN LED light source
RU Светодиодный источник света
UK Світлодіодне джерело світла

NEW

LED
TECHNOLOGY3
years
warranty

G53

13 W



LD-AR111WW13W40-10
LD-AR111NW13W40-10



LD-AR111WW13W40-00
LD-AR111NW13W40-00

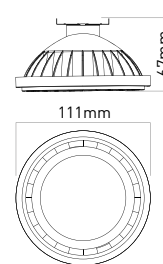

LD-AR111WW13W40-10	12,5 W	F	3000 K	1100 lm	40°	113 g	5902801343599
LD-AR111NW13W40-10			4000 K	1250 lm	40°		5902801343667
LD-AR111WW13W120-10			3000 K	1100 lm	120°		5902801347818
LD-AR111NW13W120-10			4000 K	1250 lm	120°		5902801347955
LD-AR111WW13W40-00			3000 K	1100 lm	40°		5902801347511
LD-AR111NW13W40-00			4000 K	1250 lm	40°		5902801343759
LD-AR111WW13W120-00			3000 K	1100 lm	120°		5902801347986
LD-AR111NW13W120-00			4000 K	1250 lm	120°		5902801348310



PL Źródło światła LED
EN LED light source
RU Светодиодный источник света
UK Світлодіодне джерело світла

NEW

LED
TECHNOLOGY

3
years
warranty

GU10

11 W

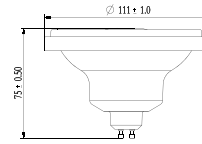

LD-ES111WW11W25AG-01	11,0 W	F	96 mA	3000 K	850 lm	25°	95 g	5902801343711
LD-ES111NW11W25AG-01				4000 K	900 lm			5902801347498

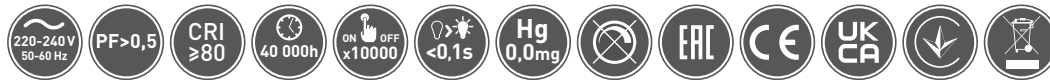

PL Źródło światła LED
EN LED light source
RU Светодиодный источник света
UK Світлодіодне джерело світла

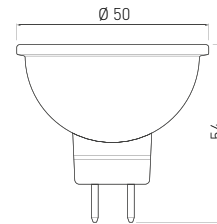

3
years
warranty

LED
TECHNOLOGY

MR16

4 W



LD-SM4016-30	4,0 W	4,0 W = 30 W	G	3000 K	320 lm	30 g	5901867190079
LD-SM4016-40				4000 K			5902801309328
LD-SM4016-64				6400 K			5901867190109

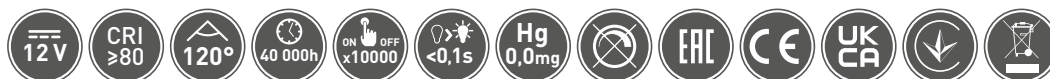

PL Źródło światła LED
EN LED light source
RU Светодиодный источник света
UK Світлодіодне джерело світла

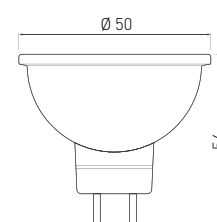

3
years
warranty

LED
TECHNOLOGY

MR16

6 W



LD-SM6016-30	6,0 W	6,0 W = 44 W	G	3000 K	540 lm	30 g	5901867190048
LD-SM6016-40				4000 K			5902801338281
LD-SM6016-64				6400 K			5902801339738

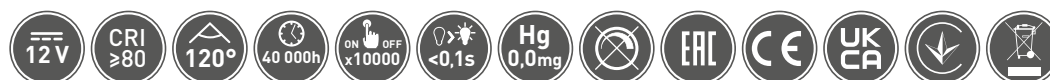

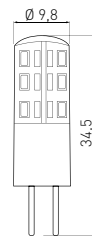

PL Źródło światła LED
EN LED light source
RU Светодиодный источник света
UK Світлодіодне джерело світла

LED
TECHNOLOGY

G4

1 W



LD-G4S1115-32	1,1 W	1,1 W = 11 W	G	3000 K	100 lm	3 g	5902801328657
LD-G4S1115-45				4000 K			5902801328329

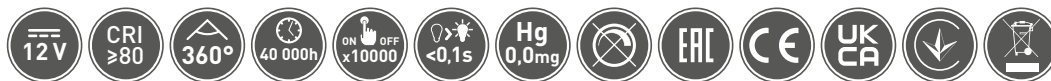

PL Źródło światła LED
EN LED light source
RU Светодиодный источник света
UK Світлодіодне джерело світла

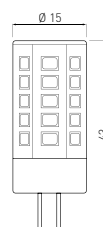
LED
TECHNOLOGY

G4

3 W



LD-G4P30W-30	3,0 W	3,0 W = 26 W	G	3000 K	260 lm	11 g	5902801338533
LD-G4P30W-40				4000 K			5902801338519

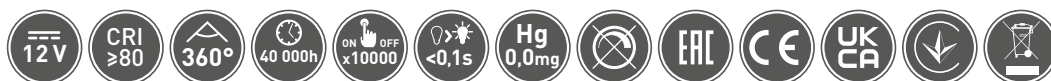

PL Źródło światła LED
EN LED light source
RU Светодиодный источник света
UK Світлодіодне джерело світла



LD-G4015W-30

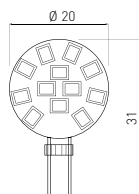

LD-G4020W-30

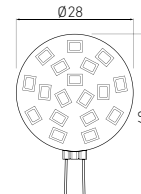
LED
TECHNOLOGY

G4

2 - 3 W



LD-G4018W-30	1,8 W	1,8 W = 16 W	G	3000 K	150 lm	1,7 g	5902801339042
LD-G4025W-30	2,5 W	2,5 W = 25 W	F		250 lm	2,9 g	5902801338908

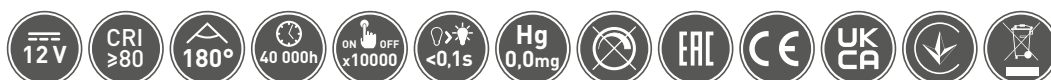





ŚWIETLÓWKI LED TYPU T8
LED LIGHT SOURCES T8
СВЕТОДИОДНЫЕ ЛАМПЫ ТИПА Т8
СВІТЛОДІОДНІ ЛАМПИ ТИПУ Т8

PL Źródło światła LED
EN LED light source
RU Светодиодная лампа типа T8
UK Світлодіодна лампа типу T8



SW-NSZT810W-60N, SW-ZSZT810W-60N



SW-NSZT819W-120N, SW-ZSZT819W-120N



SW-NSZT824W-150N, SW-ZSZT824W-150N

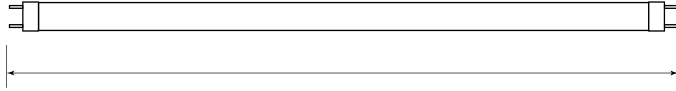

600 mm SW-NSZT810W-60N, SW-ZSZT810W-60N
1200 mm SW-NSZT819W-120N, SW-ZSZT819W-120N
1500 mm SW-NSZT824W-150N, SW-ZSZT824W-150N

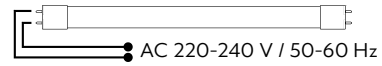

	W	Ei	mA	Color	lm	g	Barcode
SW-NSZT810W-60N	9,1 W	F	80 mA	4000 K	1000 lm	115 g	5902801366369
SW-ZSZT810W-60N	9,1W		80 mA	6400 K	1000 lm	115 g	5902801367250
SW-NSZT818W-120N	18,0 W		157 mA	4000 K	1900 lm	220 g	5902801367212
SW-ZSZT818W-120N	18,0 W		157 mA	6400 K	1900 lm	220 g	5902801367281
SW-NSZT822W-150N	22,0 W		192 mA	4000 K	2400 lm	275 g	5902801367229
SW-ZSZT822W-150N	22,0 W		192 mA	6400 K	2400 lm	275 g	5902801367304



PL Źródło światła LED, T8
EN LED light source, T8
RU Светодиодная лампа типа T8
UK Світлодіодна лампа типу T8

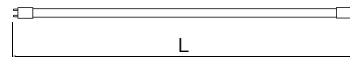
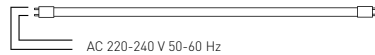

	W	Ei	mA	Color	lm	L	Barcode
SW-HLSZT809W-60	9,0 W	E	78 mA	4000 K	1050 lm	600 mm	5902801241444
SW-HLSZT818W-120	18,0 W		157 mA		2150 lm	1200 mm	5902801241451
SW-HLSZT824W-150	24,0 W		209 mA		2850 lm	1500 mm	5902801241871





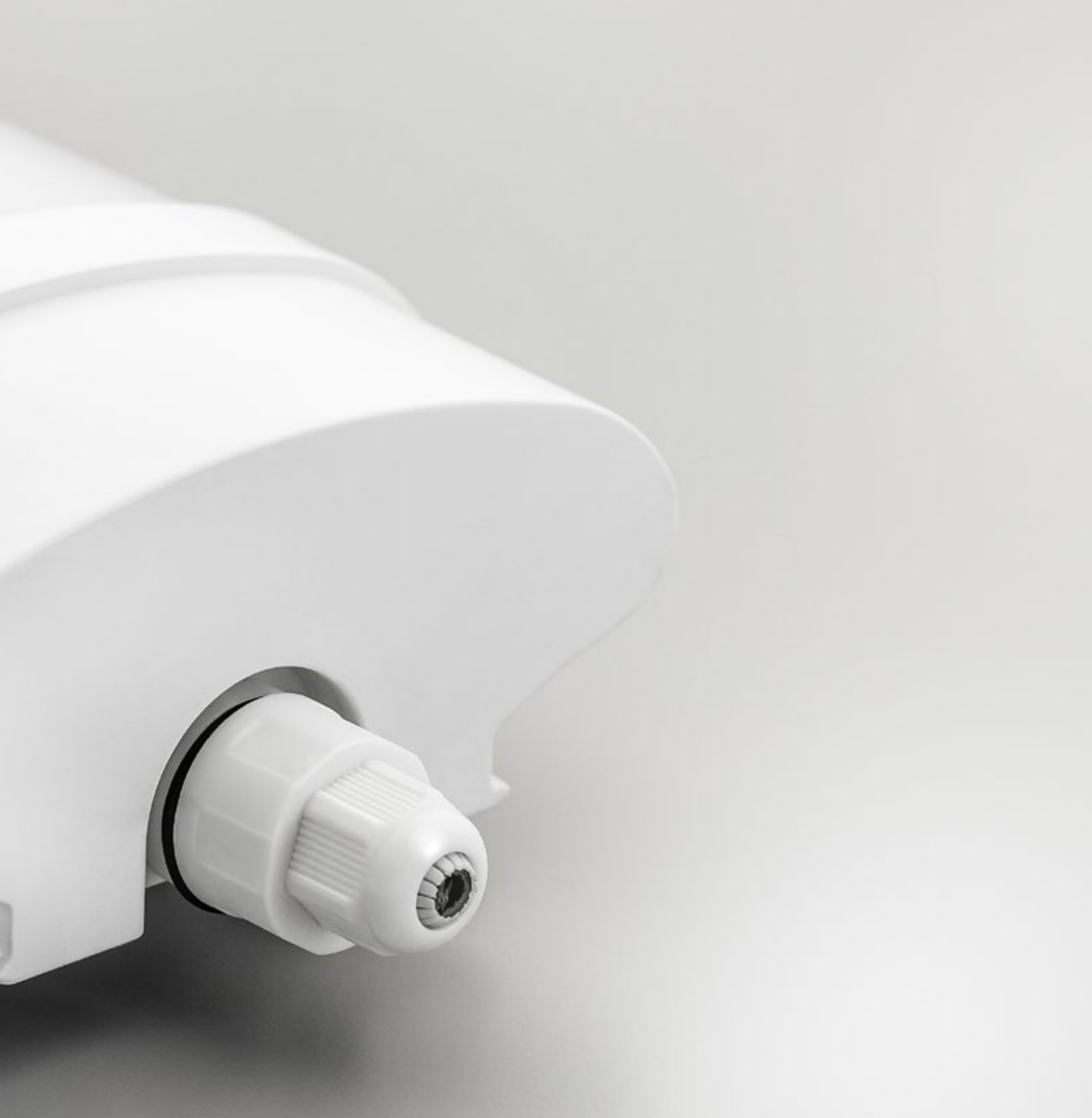

OPRAWY TECHNICZNE I PRZEMYSŁOWE
TECHNICAL AND INDUSTRIAL FIXTURES
ТЕХНИЧЕСКИЕ И ПРОМЫШЛЕННЫЕ СВЕТИЛЬНИКИ
ТЕХНІЧНІ ТА ПРОМИСЛОВІ СВІТИЛЬНИКИ



Panele i oprawy LED LED panels and fixtures Светодиодные панели Світлодіодні панелі.....	65
Oprawy przemysłowe LED Industrial LED fixtures Светодиодные промышленные светильники Світлодіодні промислові світильники.....	76
Plafoniere i oprawy kanałowe LED LED ceiling and bulkhead fixtures Потолочные светильники и светильники ЖКХ Світлодіодні світильники та світильники ЖКГ	86
Oprawy LED typu downlight LED downlights Светильники типа downlight Світильники типу downlight	104
Naświetlacze LED LED Floodlights Светодиодные прожекторы Світлодіодні прожектори.....	126
Oprawy LED typu high bay High bay LED luminaires Светодиодные High bay светильники Світлодіодні high bay світильники	132
Oprawy uliczne i parkowe LED Street and park LED luminaires Светодиодные уличные и парковые светильники Світлодіодні вуличні та паркові світильники	138
Oprawy awaryjne LED LED emergency light fixtures Аварийные светильники Аварійні світильники.....	142
Oprawy rastrowe, kloszowe Louvre fixtures Растровые светильники Растрові світильники.....	146
Oprawy przemysłowe Industrial fixtures Промышленные светильники Промислові світильники	150
Plafoniere i oprawy kanałowe Ceiling and bulkhead fixtures ЖКХ светильники ЖКГ світильники	154
Oprawy warsztatowe i latarki LED Workshop fixtures and LED flashlights Светильники для мастерской и LED-фонари Світильники для майстерень та світлодіодні ліхтарики	162



PANELE I OPRAWY LED
LED PANELS AND FIXTURES
СВЕТОДИОДНЫЕ ПАНЕЛИ
СВІТЛОДІОДНІ ПАНЕЛІ

PL Ramka LED
EN LED frame
RU Светодиодная рамка
UK Світлодіодна рамка

AKORDITA

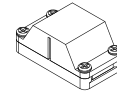

Aksesoria,
Accessories,
Аксессуары,
Аксесуари:
LZ-KO12KO-10

LED
TECHNOLOGY



40 W

3 years
warranty

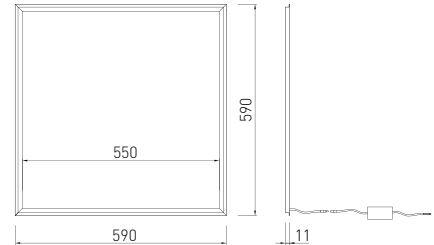
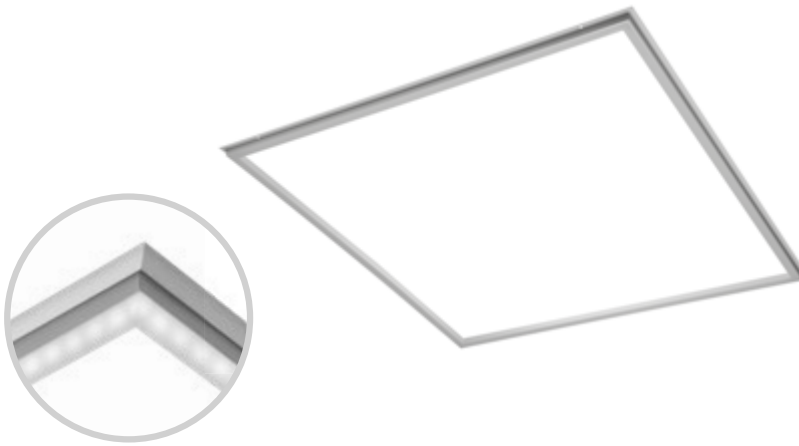

Technical & industrial
fixtures



LD-AKO4060-NB

40 W

● 4000 K

3600 lm

aluminium,
aluminium,
алюминий,
алюміній

biały,
white,
белый,
білий

500 g

5902801039966



PL Oprawa LED
EN LED fitting
RU Светодиодный светильник
UK Світлодіодний світильник

NEW

LED
TECHNOLOGY



36 W

3 years
warranty

UGR<16

SOLID

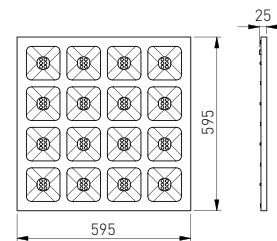

LD-SOL36W40-NB

36 W

● 4000 K

4800 lm

biały, white, белый, білий

2850 g

5902801393372





PL Oprawa LED
EN LED fitting
RU Светодиодный светильник
UK Світлодіодний світильник



inside
40 W

5 years
warranty

MODULAR

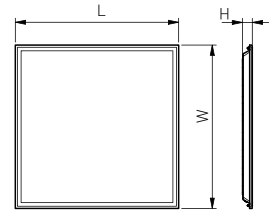

	L	W	H
LD-MOD4060-NB	595 mm	595 mm	25 mm

Technical & industrial
fixtures



Folder	W	Color	Light	Material	Color	Weight	Barcode
LD-MOD4060-NB	40 W	4000 K	4800 lm	aluminium, aluminium, алюминий, алюміній	biały, white, белый, білий	1800 g	5902801372698

220-240 V 50-60 Hz | IP54 | IK08 | PF>0,9 | CRI ≥80 | 120° | 60 000h | ON/OFF x10000 | CE | EAC

PL Oprawa LED
EN LED fitting
RU Светодиодный светильник
UK Світлодіодний світильник



inside
40 W

UGR<19

5 years
warranty

MODULAR UGR

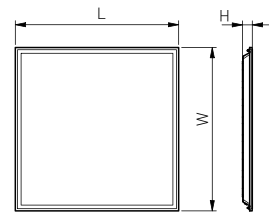

Folder	L	W	H
LD-MOD4060UGR-NB	595 mm	595 mm	25 mm
LD-MOD12030UGR-NB	295 mm	1195 mm	25 mm

Folder	W	Color	Light	Material	Color	Weight	Barcode
LD-MOD4060UGR-NB	40 W	4000 K	4200 lm	aluminium, aluminium, алюминий, алюміній	biały, white, белый, білий	1800 g	5902801372872
LD-MOD12030UGR-NB							5902801372636

220-240 V 50-60 Hz | IP54 | IK08 | PF>0,9 | CRI ≥80 | 120° | 60 000h | ON/OFF x10000 | CE | EAC

PL Panel LED
EN LED Panel
RU Светодиодная панель
UK Світлодіодна панель



40 W



GALAXY

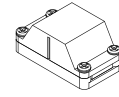

Aksesoria,
Accessories,
Аксессуары,
Аксесуари:
LZ-KO12KO-10

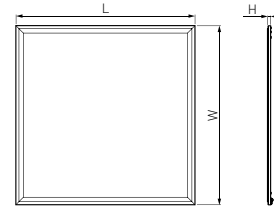

LD-GL40060-NB	40 W	● 4000 K	4400 lm	aluminium, aluminium, алюминий, алюміній	595 × 595 × 10	biały, white, белый, білий	2700 g	5901867195180
LD-GL40120-NB				1195 × 295 × 10	5901867195357			



Technical & industrial
fixtures



PL Panel LED
EN LED Panel
RU Светодиодная панель
UK Світлодіодна панель

GALAXY UGR

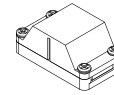

Aksesoria,
Accessories,
Аксессуары,
Аксесуары:
LZ-KOI2KO-10

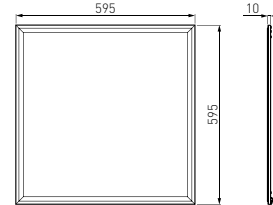

Technical & industrial
fixtures



LD-GL40060UGR-NB	40 W	4000 K	4400 lm	aluminium, aluminium, алюминий, алюміній	biały, white, белый, білий	2700 g	5901867195456
------------------	------	--------	---------	---	----------------------------	--------	---------------



PL Panel LED
EN LED Panel
RU Светодиодная панель
UK Світлодіодна панель

MASTER

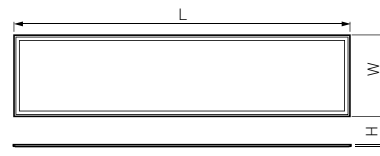

NEW



LD-MA24063-NB	24 W	4000 K	2400 lm	aluminium, aluminium, алюминий, алюміній	595 x 295 x 8	biały, white, белый, білий	1300 g	5902801372568
LD-MA40060-NB	40 W		4200 lm		595 x 595 x 10		1820 g	5902801292132
LD-MA40312-NB			1195 x 295 x 10		1860 g		5902801292156	





PL Panel LED
EN LED Panel
RU Светодиодная панель
UK Світлодіодна панель

KING+

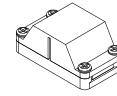

Aksesoria,
Accessories,
Аксессуары,
Аксесуари:
LZ-KO12KO-10

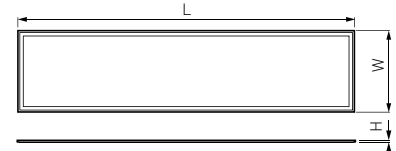

Technical & industrial
fixtures



LD-KNG45060-NB	45 W	4000 K	4500 lm	aluminium, aluminium, алюминий, алюміній	595 x 595 x 10	biały, white, белый, білий	2780 g	5902801270307
LD-KNG45312-NB					1195 x 295 x 10		2680 g	5902801270567



PL Panel LED
EN LED Panel
RU Светодиодная панель
UK Світлодіодна панель

ARGO

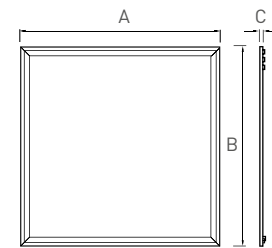

	A	B	C
LD-ARG30W60-NB	445 mm	445 mm	26 mm
LD-ARG40W60-NB	595 mm	595 mm	
LD-ARG55W60-NB	595 mm	595 mm	



LD-ARG30W60-NB	30 W	4000 K	3000 lm	metal + tworzywo, metal + plastic, металл + пластик, метал + пластик	biały, white, белый, білий	1500 g	5902801312359
LD-ARG40W60-NB	40 W		4000 lm			2000 g	5902801345449
LD-ARG55W60-NB*	55 W		5500 lm			2000 g	5902801345456



PL Panel LED
EN LED Panel
RU Светодиодная панель
UK Світлодіодна панель



40 W



ELZA



Akcesoria,
Accessories,
Аксессуары,
Аксесуари:
LZ-KOI2KO-10

LD-DE40062-NB	40 W	● 4000 K	4400 lm	aluminium, aluminium, алюминий, алюміній	biały, white, белый, білий	3000 g	5902801125379



Technical & industrial fixtures

PL Panel LED
EN LED Panel
RU Светодиодная панель
UK Світлодіодна панель



40 W



ELZA UGR



LD-DE40062UGR-NB	40 W	● 4000 K	4400 lm	aluminium, aluminium, алюминий, алюміній	biały, white, белый, білий	3000 g	5902801298905



- PL Zestaw linek do podwieszania paneli
 EN Set of cables for a panel suspension
 RU Комплект кабелей для подвески панели
 UK Комплект монтажних тростиків для підвішування панелей



LK-PANELX4-00	metal, metal, металл, метал	1,5 m	4	5902801270307
---------------	-----------------------------	-------	---	---------------



- PL Zestaw do podtynkowego montażu paneli
 EN Set of the built-in panel mount
 RU Набор встроенного монтажа панелей
 UK Комплект для скритого монтажу панелей



ZM-PANELSC-00	metal, metal, металл, метал	4	5901867158079
---------------	-----------------------------	---	---------------





- PL Zestaw do montażu naściennego
 EN Set for wall mount
 RU Набор для настенных креплений
 UK Комплект для настінного монтажу панелей



ZM-PANELSU-00	metal, metal, металл, метал	4	5901867158055
---------------	-----------------------------	---	---------------

- PL Rama do montażu natynkowego paneli
- EN Surface mounted panel frames
- RU Рамка для накладного монтажа панелей
- UK Рамка для поверхневого монтажу панелей



	 LxWxH mm			
RM-DE625X625-00	625 x 625 x 43	aluminium, aluminium, алюминий, алюміній	biały, white, белый, білий	5902801073137
RM-KNG60X60-00	600 x 600 x 43			5901867168580
RM-KNG300X600-00	600 x 300 x 43			5901867179753
RM-KNG300X120-00	1200 x 300 x 43			5901867179777
GT-RM60X60-00	600x600x43			5902801276088
GT-RM30X60-00	600x300x43			5902801276163
GT-RM30X120-00	1200x300x43			5902801276071
RM-MA60X60-00	600 x 600 x 43			szary, grey, серый, сірий



OPRAWY PRZEMYSŁOWE LED
INDUSTRIAL LED FIXTURES
СВЕТОДИОДНЫЕ ПРОМЫШЛЕННЫЕ СВЕТИЛЬНИКИ
СВІТЛОДІОДНІ ПРОМИСЛОВІ СВІТИЛЬНИКИ

PL Oprawa LED hermetyczna
EN Hermetic LED fixture
RU Герметический светодиодный светильник
UK Герметичний світлодіодний світильник

BERGA

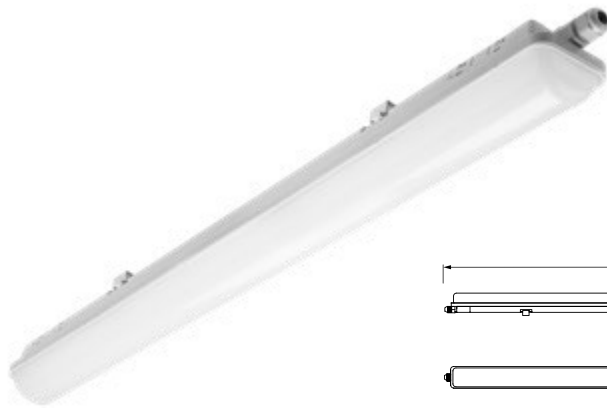

	W	LN				LxWxH mm			
LD-BERGA50W-30	50 W	max 10	● 4000 K	7000 lm	ABS/PC	1190 × 75 × 77	szary, grey, серый, сірий	1360 g	5902801253188
LD-BERGA70W-30	70 W	max 7		9800 lm				1570 × 75 × 77	1740 g



Technical & industrial fixtures

PL Oprawa LED hermetyczna
EN Hermetic LED fixture
RU Герметический светодиодный светильник
UK Герметичний світлодіодний світильник

BETIS



	W	LN				LxWxH mm			
LD-BETISD50W-30	50 W	max 22	● 4000 K	6000 lm	PC	1200 × 75 × 95	biały, white, белый, білий	680 g	5902801015670
LD-BETISD70W-30	70 W	max 15		8400 lm				1500 × 75 × 95	1350 g



PL Oprawa LED hermetyczna
EN Hermetic LED fixture
RU Герметический светодиодный светильник
UK Герметичний світлодіодний світильник

LUNAR

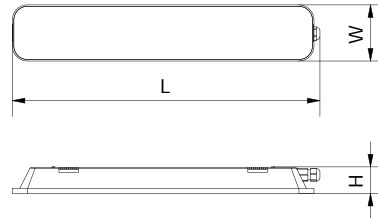

LED
TECHNOLOGY



40-80 W



Technical & industrial
fixtures



Model	Power (W)	Max LEDs	Color Temp (K)	Light Output (lm)	Material	Dimensions (mm)	Colors	Weight (g)	Barcode
LD-LUNAR60-40	40 W	max 20	● 4000 K	4000 lm	PC GLASS	620 x 118 x 53	szary, grey, серый, сірий	1400 g	5902801297571
LD-LUNAR120-80	80 W	max 10		8000 lm		1160 x 118 x 53		2400 g	5902801297625



PL Oprawa LED hermetyczna
EN Hermetic LED fixture
RU Герметический светодиодный светильник
UK Герметичний світлодіодний світильник

BESTA

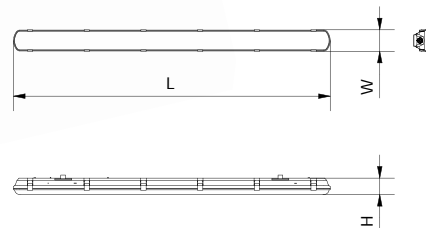

LED
TECHNOLOGY



40-60 W



Model	Power (W)	Max LEDs	Color Temp (K)	Light Output (lm)	Material	Dimensions (mm)	Colors	Weight (g)	Barcode
LD-BESTA40W-30	40 W	max 27	● 4000 K	5600 lm	PC	1200 x 102 x 83	biały, white, белый, білий	1500 g	5902801234163
LD-BESTA60W-30	60 W	max 18		8400 lm		1500 x 102 x 83		2000 g	5902801225642





PL Oprawa LED hermetyczna
EN Hermetic LED fixture
RU Герметический светодиодный светильник
UK Герметичний світлодіодний світильник

XARO

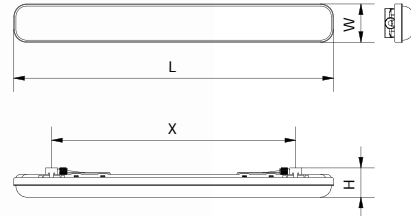
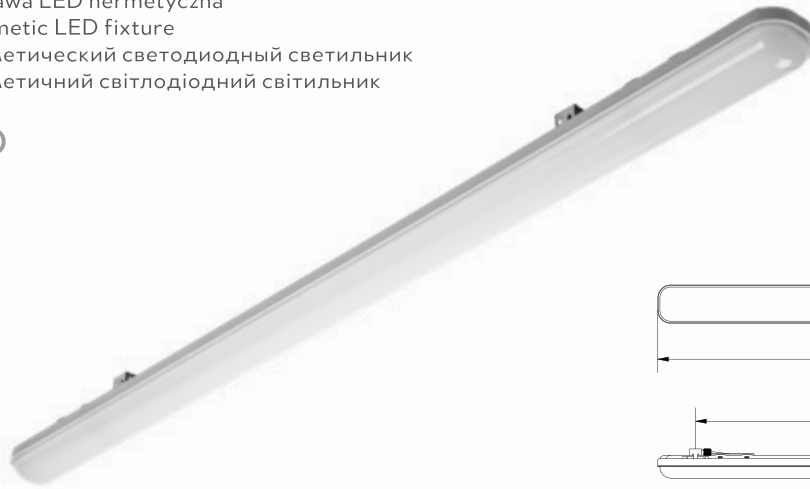

LED
TECHNOLOGY



18-48 W



Technical & industrial
fixtures



Model	Power (W)	Max LEDs	Color Temp (K)	Light Output (lm)	Material	LxWxH (mm)	X (mm)	IP Rating	Weight (g)	Barcode
LD-XARO18W-30	18 W	max 16		2200 lm		600 x 70 x 60	435-480 mm		1000 g	5902801234019
LD-XARO36W-30	36 W	max 12	● 4000 K	4400 lm	PC	1200 x 70 x 83	700-780 mm	biały, white, белый, білий	1300 g	5902801233906
LD-XARO48W-30	48 W	max 8		5800 im		1500 x 80 x 83	990-1050 mm		1800 g	5902801234248



PL Oprawa LED hermetyczna do źródeł światła LED T8
EN Fixture for LED light sources, T8
RU Герметический светильник для светодиодных ламп T8
UK Герметичний світильник для світлодіодних ламп T8

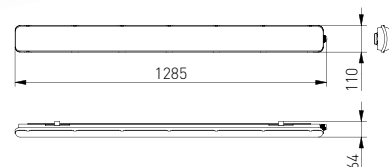

LED
TECHNOLOGY



Model	Color Temp (K)	Light Output (lm)	Material	Weight (g)	Barcode
LD-HR2X18W12-30	● 4000 K	2 x 1800 lm	szary, grey, серый, сірий	1300 g	5902801233913



PL Oprawa LED hermetyczna
EN Hermetic LED fixture
RU Герметический светодиодный светильник
UK Герметичний світлодіодний світильник

OMNIA BIS

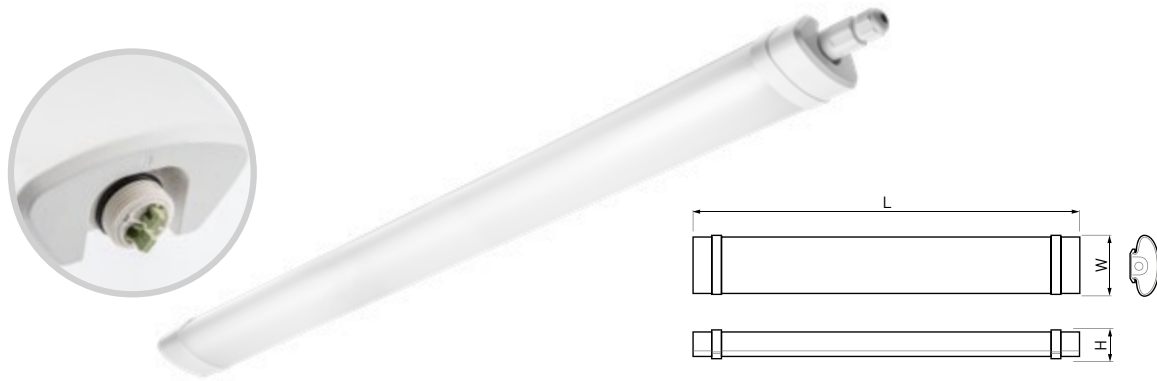

					LxWxH mm			
LD-OMN060-30B	30 W	● 4000 K	3000 lm	PC	640 x 85 x 50	biały, white, белый, білий	400 g	5902801038587
LD-OMN120-60B	60 W		6000 lm		1240 x 85 x 50		670 g	5902801038693
LD-OMN150-70B	70 W		7000 lm		1540 x 85 x 50		750 g	5902801038686



PL Oprawa LED hermetyczna
EN Hermetic LED fixture
RU Герметический светодиодный светильник
UK Герметичний світлодіодний світильник

OMNIA MAX BIS



		LN				LxWxH mm			
LD-OMN120B-75M	75 W	max 16	● 4000 K	7500 lm	PC	1240 x 120 x 54	biały, white, белый, білий	820 g	5902801233975
LD-OMN150B-90M	90 W	max 13		9000 lm		1540 x 120 x 54		980 g	5902801233999

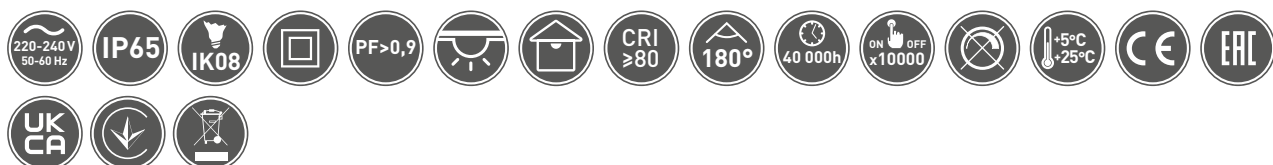

PL Oprawa LED hermetyczna
EN Hermetic LED fixture
RU Герметический светодиодный светильник
UK Герметичний світлодіодний світильник

Technical & industrial
fixtures

LUMIA



LD-LUM120-30P	36 W	max 10	● 4000 K	3600 lm	PC	1205 × 49 × 56	biały, white, белый, білий	670 g	5901867155733
LD-LUM150-30P	45 W	max 8		4500 lm		1512 × 49 × 56		680 g	5901867155757

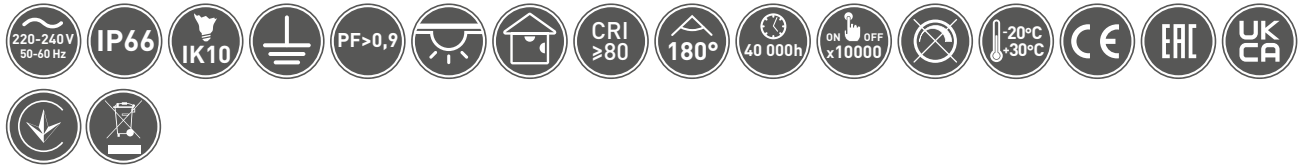

PL Oprawa LED hermetyczna
EN Hermetic LED fixture
RU Герметический светодиодный светильник
UK Герметичний світлодіодний світильник

HEROS

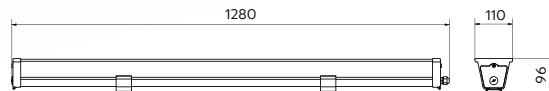
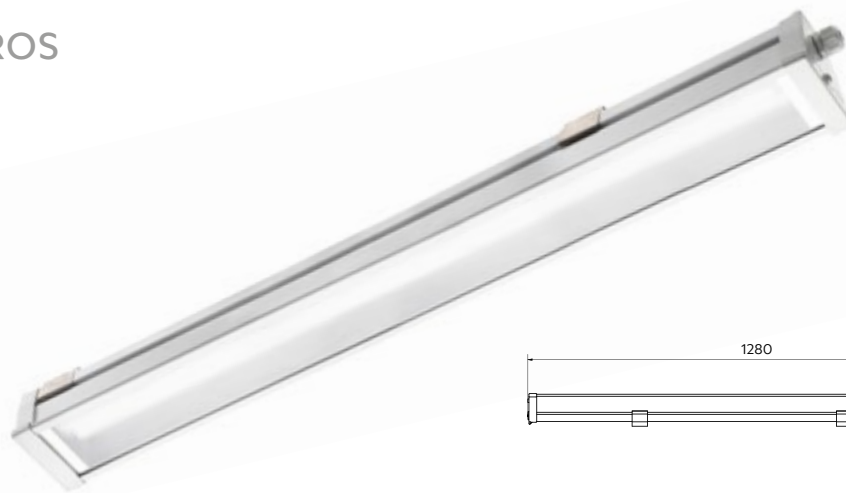

LD-HER60W12-NB	60 W	20	● 4000 K	8400 lm	aluminium + szkło hartowane, aluminium + tempered glass, алюминий + закаленное стекло, алюміній + гартоване скло	biały, white, белый, білий	4200 g	5902801274404
----------------	------	----	----------	---------	---	-------------------------------------	--------	---------------



PL Oprawa LED
EN LED fixture
RU Светодиодный светильник
UK Світлодіодний світильник

LONGI

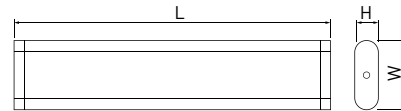
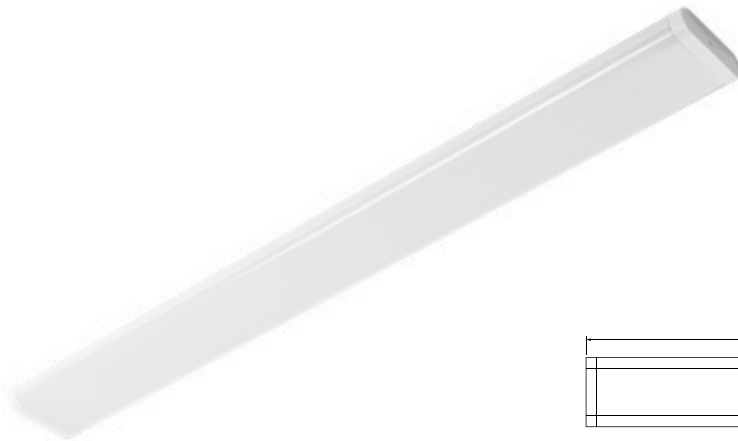

Folder	Wattage	Color Temp	Beam Angle	Material	Dimensions (mm)	Color	PF	Weight	Barcode
LD-LNG24WB-NB	24 W	● 4000 K	2400 lm	aluminium, PC, aluminium, PC, алюминий, PC, алюміній, PC	600 × 130 × 42	biały, white, белый, білий	PF > 0,5	800 g	5902801374876
LD-LNG48WB-NB	48 W		4800 lm	1200 × 130 × 42	PF > 0,9	1600 g	5902801330803		

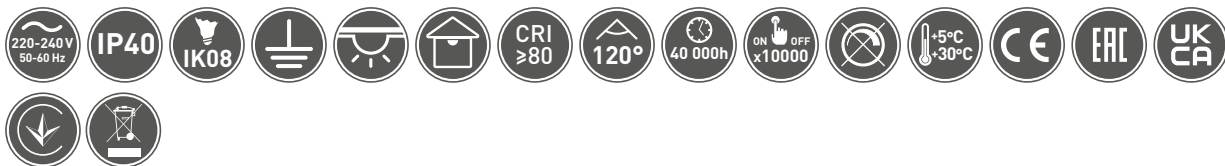

PL Oprawa LED natynkowa
EN Surface mounted LED fixture
RU Светодиодный накладной светильник
UK Світлодіодний світильник для поверхневого монтажу

ZEFIR PRO

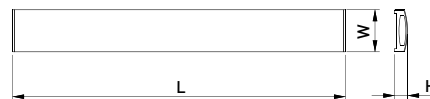

Folder	Wattage	Color Temp	Beam Angle	Material	Dimensions (mm)	Color	PF	Weight	Barcode
LD-ZFPL24W06-NB	24 W	● 4000 K	2200 lm	aluminium, aluminium, алюминий, алюміній	591 × 148,5 × 52,5	biały, white, белый, білий	PF > 0,5	825 g	5902801218170
LD-ZFPL48W12-NB	48 W		4400 lm	1191 × 148,5 × 52,5	PF > 0,9	1475 g	5902801278624		

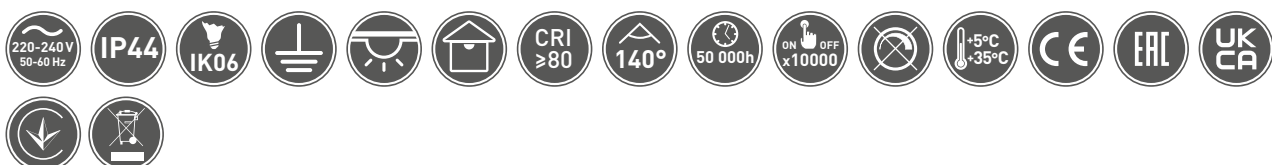

PL Oprawa LED natynkowa
EN Surface mounted LED fixture
RU Светодиодный накладной светильник
UK Світлодіодний світильник для поверхневого монтажу

ASPEN

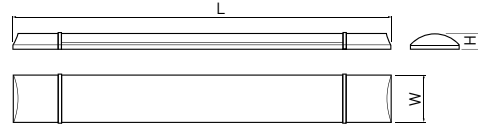
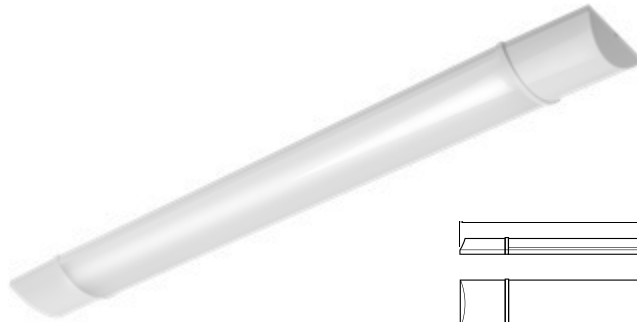

Technical & industrial
fixtures



LD-OLL20W-CB	20 W	● 3000 K	1800 lm	PC	600 × 68 × 23	biały, white белый, білий	PF > 0,5	190 g	5902801284151
LD-OLL20W-NB		● 4000 K							5902801010453
LD-OLL40W-CB	40 W	● 3000 K	3600 lm		1200 × 68 × 23		PF > 0,9	360 g	5902801285011
LD-OLL40W-NB		● 4000 K							5902801010460
LD-OLL50W-CB	50 W	● 3000 K	4500 lm		1500 × 68 × 23		PF > 0,9	475 g	5902801284274
LD-OLL50W-NB		● 4000 K							5902801010477

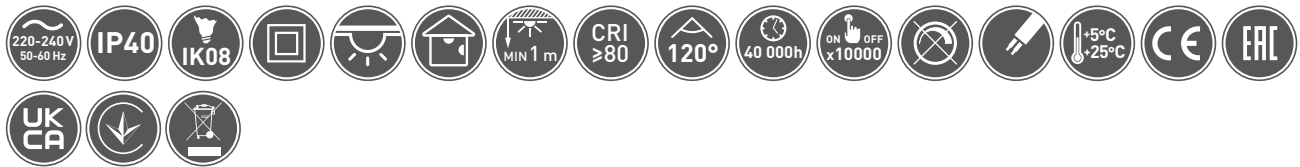

PL Oprawa LED hermetyczna
EN Hermetic LED fixture
RU Герметический светодиодный светильник
UK Герметичний світлодіодний світильник

ONTARIO

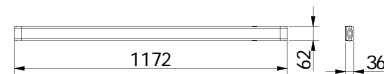

LD-ONT120-36	36 W	max 4	● 4000 K	3600 lm	PC	biały, white, белый, білий	470 g	5902801247255
--------------	------	-------	----------	---------	----	-------------------------------	-------	---------------





			
LD-ONTEND-00	biały, white, белый, білий	20 g	5902801247453
LD-ONTMCI-00		30 g	5902801245060
LD-ONTPWR-00		60 g	5902801245022





PLAFONIERY I OPRAWY KANAŁOWE LED
LED CEILING AND BULKHEAD FIXTURES
ПОТОЛОЧНЫЕ СВЕТИЛЬНИКИ И СВЕТИЛЬНИКИ ЖКХ
СВІТЛОДІЮДНІ СВЕТИЛЬНИКИ ТА СВЕТИЛЬНИКИ ЖКГ

PL Plafoniera LED
EN LED ceiling light fixture
RU Светодиодный светильник
UK Світлодіодний світильник

BESA

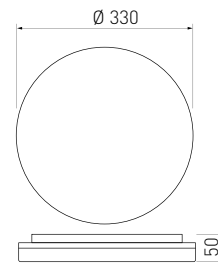

LD-BES24WOK-30	24 W	● 3000 K	2400 lm	PC	biała, white, белый, білий	880 g	5902801289255
LD-BES24WOK-40		● 4000 K					5902801041532



PL Plafoniera LED
EN LED ceiling light fixture
RU Светодиодный светильник
UK Світлодіодний світильник

BESA

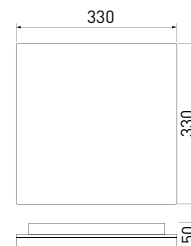

LD-BES24WKW-30	24 W	● 3000 K	2400 lm	PC	biała, white, белый, білий	880 g	5902801289385
LD-BES24WKW-40		● 4000 K					5902801041891



Technical & industrial
fixtures



PL Plafoniera LED
EN LED ceiling light fixture
RU Светодиодный светильник
UK Світлодіодний світильник

STARS BIS

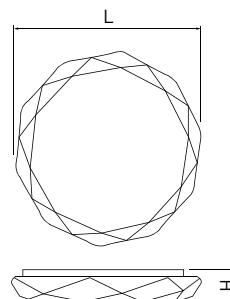

Technical & industrial fixtures



LD-STARS24W-NW-00	24 W	● 4000 K	1920 lm	PC	410x105	0,5	1160 g	5902801392139
LD-STARS48W-NW-00	48 W		3840 lm		510x110	0,9	2520 g	5902801326127



PL Plafoniera LED
EN LED ceiling light fixture
RU Светодиодный светильник
UK Світлодіодний світильник

MOON

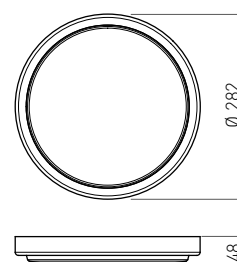

PL Plafoniera LED
EN LED ceiling light fixture
RU Светодиодный светильник
UK Світлодіодний світильник



LD-MOON12W-NB	12 W	● 4000 K	1200 lm	PC/PC	biała, white, белый, білий	630 g	5902801219443
LD-MOON18W-NB	18 W		1800 lm				5902801219498





PL Plafoniera LED
EN LED ceiling light fitting
RU Светодиодный потолочный светильник
UK Світлодіодний світильник



20-30 W



FENIX



Technical & industrial
fixtures



LD-FEN20W-NW-00	20W	● 4000 K	2000 lm	akryl, acrylic, акрил	biały, white белый, білий	300x83	0,5	850 g	5902801326318
LD-FEN30W-NW-00	30W		3000 lm	акрил	білий	345x83	0,9	900 g	5902801326424



PL Plafoniera LED
EN LED ceiling light fitting
RU Светодиодный потолочный светильник
UK Світлодіодний світильник



12-48 W



SATURN BIS



LD-SATU12W-NW-00	12 W	● 4000 K	960lm	akryl, acrylic, акрил	biały, white белый, білий	245x59	0,5	550 g	5902801391958
LD-SATU18W-NW-00	18 W		1440lm			315x59		860 g	5902801391941
LD-SATU24W-NW-00	24 W		1920lm			375x59		1190 g	5902801392146
LD-SATU32W-NW-00	32 W		2560 lm			375x59	1400 g	5902801367045	
LD-SATU48W-NW-00	48 W		4020lm			475x59	2430 g	5902801334269	



PL Plafoniera LED
EN LED ceiling light fixture
RU Светодиодный светильник
UK Світлодіодний світильник

SATURN

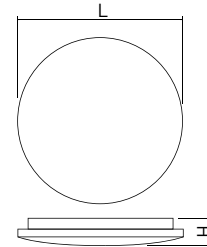

12-24 W



Technical & industrial fixtures

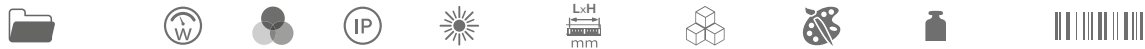

LD-SATU12WM-NB	12 W	● 4000 K	IP 44	900 lm	ø245 × 59	akryl, acrylic, акрил, акрил	biały, white белый, білий	390 g	5902801285134
LD-SATU18WM-NB	18 W			1300 lm	ø290 × 61			520 g	5902801285264
LD-SATU24WM-NB	24 W			1600 lm	ø315 × 67			660 g	5902801285110



PL Plafoniera LED
EN LED ceiling light fitting
RU Светодиодный потолочный светильник
UK Світлодіодний світильник

ATOL

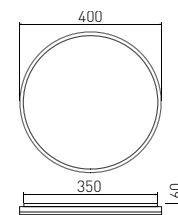

NEW



32 W



LD-ATOL32W-NW-10	32 W	● 4000 K	2560 lm	akryl, acrylic, акрил, акрил	czarny, black, черный, чорний	1400 g	5902801392122
LD-ATOL32W-WW-10		● 3000 K					5902801366703
LD-ATOL32W-NW-02		● 4000 K			inox, inox, иннокс, інокс		5902801350283
LD-ATOL32W-WW-02		● 3000 K					5902801366512
LD-ATOL32W-NW-40		● 4000 K			złoty, gold, золото, золото		5902801350207
LD-ATOL32W-WW-40		● 3000 K					5902801366550



PL Plafoniera LED
EN LED ceiling light fixture
RU Светодиодный светильник
UK Світлодіодний світильник

TOKIO

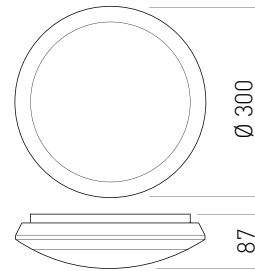

LED
LIGHTING



22 W



Technical & industrial
fixtures



LD-TOK22W-40	22 W	● 4000 K	2000 lm	PC / PC	biała, white, белый, білий	1000 g	5902801283888
--------------	------	----------	---------	---------	-------------------------------------	--------	---------------



PL Plafoniera LED z czujnikiem zmierzchowym
EN LED ceiling light fixture with dusk sensor
RU Светодиодный светильник с сумеречным датчиком
UK Світлодіодний світильник з датчиком сутінків

TOKIO

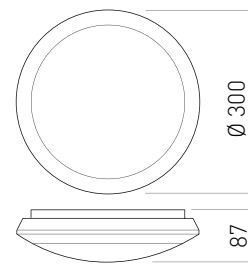

LED
LIGHTING



16 W



LD-TOK16WP-40	16 W	● 4000 K	1200 lm	PC/PC	biała, white, белый, білий	1000 g	5902801001840
---------------	------	----------	---------	-------	-------------------------------------	--------	---------------



PL Plafoniera LED z mikrofalowym czujnikiem ruchu
EN LED ceiling light fixture with a microwave motion sensor
RU Светодиодный светильник с микроволновым датчиком движения
UK Світлодіодний світильник з мікрохвильовим датчиком руху

TOKIO

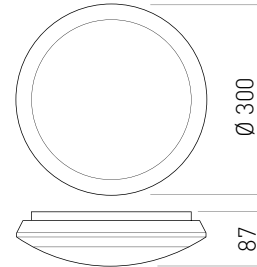

LD-TOK16WD-40	16 W	● 4000 K	1200 lm	PC/PC	biała, white, белый, білий	1000 g	5902801001840
LD-TOK22WD-40	22 W		2000 lm				5902801001826

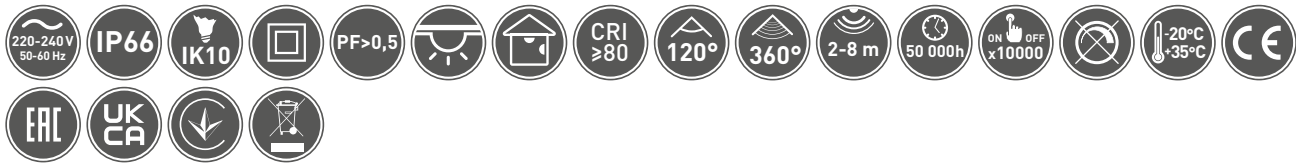

Technical & industrial fixtures



PL Plafoniera LED z mikrofalowym czujnikiem ruchu
EN LED ceiling light fixture with microwave sensor
RU Светодиодный светильник с микроволновым датчиком движения
UK Світлодіодний світильник з мікрохвильовим датчиком руху

OSAKA

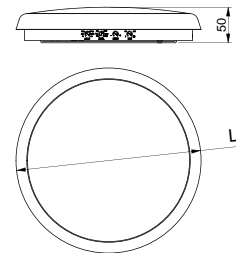

LD-OSA16WD-40	16 W	● 4000 K	1450 lm	PC/PC	ø260	biała, white, белый, білий	880 g	5902801284892
LD-OSA22WD-40	22 W		2000 lm		ø300		920 g	5902801282188





- PL Plafoniera LED z mikrofalowym czujnikiem ruchu
- EN LED ceiling light fitting with a microwave motion sensor
- RU Потолочный светодиодный светильник с микроволновым датчиком движения
- UK Стельовий світлодіодний світильник з мікрохвильовим датчиком руху

ASTI

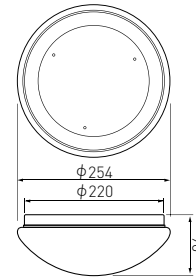

Technical & industrial fixtures

LD-ASTID13-NW-00	13 W	4000 K	1100 lm	tworzywo sztuczne, plastic, пластмасса, пластик	biała, white, белый, білий	450 g	5902801360558

220-240 V 50-60 Hz | IP44 | IK06 | PF>0,5 | CRI ≥80 | 120° | max 8m | 40 000h | ON/OFF x10000 | CE | EAC | UK CA | |

- PL Plafoniera LED
- EN LED ceiling light fitting
- RU Светодиодный потолочный светильник
- UK Світлодіодний світильник

ASTRA

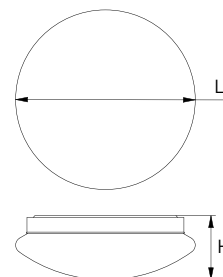

LD-ASTR12W-NW-00	12W	4000 K	960lm	akryl, acrylic, акрил, акрил	biała, white, белый, білий	245x59	530g	5902801391934
LD-ASTR18W-NW-00	18W		1440lm			315x59	880g	5902801391354
LD-ASTR24W-NW-00	24W		1920lm			375x59	1180g	5902801391965

220-240 V 50-60 Hz | IP54 | IK06 | PF>0,5 | CRI ≥80 | 120° | 40 000h | ON/OFF x10000 | | CE | EAC | UK CA | |

- PL Plafoniera LED z mikrofalowym czujnikiem ruchu
- EN LED ceiling light fitting with a microwave motion sensor
- RU Потолочный светодиодный светильник с микроволновым датчиком движения
- UK Стельовий світлодіодний світильник з мікрохвильовим датчиком руху



12-24 W



Technical & industrial
fixtures

ASTRA

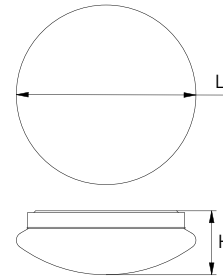

LD-ASTR12WM-NW-00	12W	● 4000 K	960lm	akryl, acrylic, акрил, акрил	biała, white, белый, білий	245x59	600 g	5902801392177
LD-ASTR18WM-NW-00	18W		1440lm			315x59	950 g	5902801350221
LD-ASTR24WM-NW-00	24W		1920lm			375x59	1250 g	5902801350238

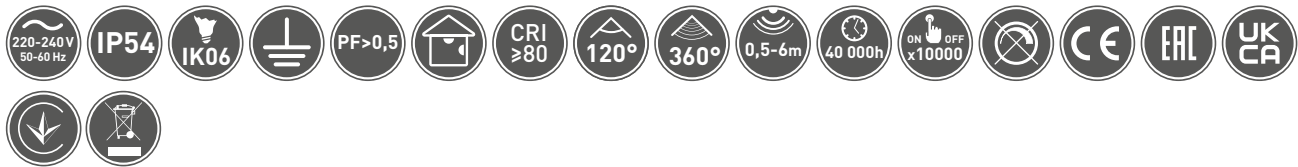

- PL Plafoniera LED z czujnikiem ruchu
- EN LED ceiling light fixture with motion sensor
- RU Светодиодный светильник с датчиком движения
- UK Світлодіодний світильник з датчиком руху



16 W



LOGOS

360°

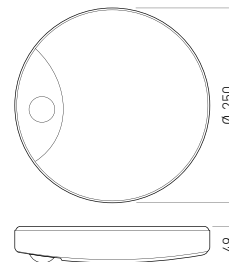

LD-LOG16W-LED	16 W	● 4000 K	1200 lm	tworzywo sztuczne, plastic, пластмасса, пластик	biała, white, белый, білий	508 g	5901867197085
---------------	------	----------	---------	--	-------------------------------------	-------	---------------



PL Plafoniera LED z czujnikiem zmierzchowym
 EN LED ceiling light fixture with dusk sensor
 RU Светодиодный светильник с сумеречным датчиком
 UK Світлодіодний світильник з датчиком сутінків

MACARI

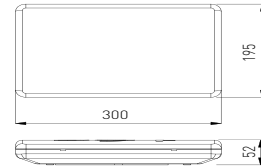

Zestaw liter i cyfr w komplecie.
 Set of letters and numbers included.
 Набор букв и цифр вклучен.
 Набор букв і цифр вклучений.



12 W



Technical & industrial
 fixtures



LD-MCR12W-NB	12 W	● 4000 K	950 lm	PC	biała, white, белый, білий	680 g	5902801294143



PL Plafoniera LED z czujnikiem ruchu
 EN LED ceiling light fixture with motion sensor
 RU Светодиодный светильник с датчиком движения
 UK Світлодіодний світильник з датчиком руху

Technical & industrial fixtures



OS-ITL12W-LED	12 W	● 4000 K	900 lm	PC	biała, white, белый, білий	560 g	5901867158291
OS-ITL16W-LED	16 W		1200 lm				5901867197016

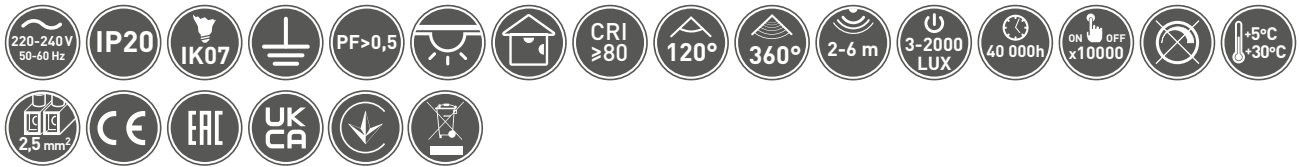

PL Plafoniera LED z czujnikiem ruchu
 EN LED ceiling light fixture with motion sensor
 RU Светодиодный светильник с датчиком движения
 UK Світлодіодний світильник з датчиком руху



OS-ITL12WKW-LED	12 W	● 4000 K	900 lm	PC	biała, white, белый, білий	420 g	5902801282089

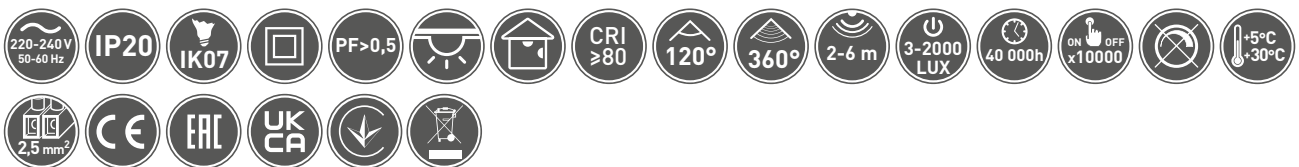

PL Oprawa kanałowa LED
EN LED bulkhead fixture
RU Светодиодный ЖКХ светильник
UK Світлодіодний ЖКГ світильник

LUXIA

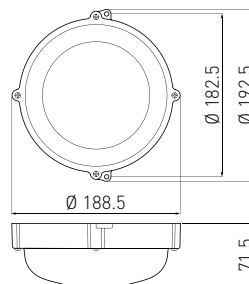

LED



10 W



Technical & industrial
fixtures



LD-KALU100K-40	10 W	● 4000 K	700 lm	PC / PC	biała, white, белый, білий	250 g	5901867169204
----------------	------	----------	--------	---------	-------------------------------------	-------	---------------



PL Oprawa kanałowa LED
EN LED bulkhead fixture
RU Светодиодный ЖКХ светильник
UK Світлодіодний ЖКГ світильник

LUXIA

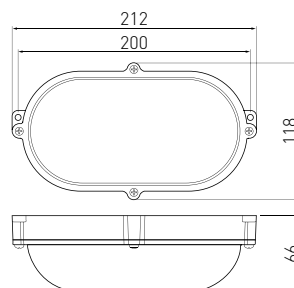

LED



10 W



LD-KALU100W-40	10 W	● 4000 K	700 lm	PC / PC	biała, white, белый, білий	250 g	5901867169228
----------------	------	----------	--------	---------	-------------------------------------	-------	---------------



PL Oprawa kanałowa LED
EN LED bulkhead fixture
RU Светодиодный ЖКХ светильник
UK Світлодіодний ЖКГ світильник

TWIST

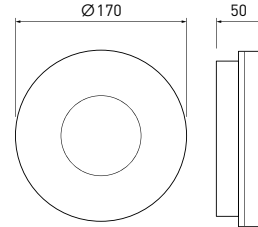

LED
TECHNOLOGY



10 W

3 years
warranty

Technical & industrial
fixtures



LD-TWI10WOK-40	10 W	● 4000 K	750 lm	PC	czarny, black, черный, чорний	300 g	5902801041303
----------------	------	----------	--------	----	--	-------	---------------

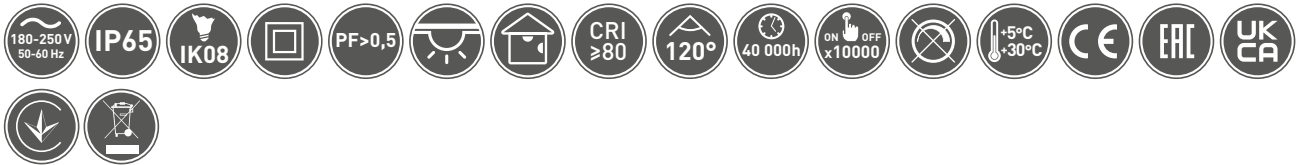

PL Oprawa kanałowa LED
EN LED bulkhead fixture
RU Светодиодный ЖКХ светильник
UK Світлодіодний ЖКГ світильник

TWIST

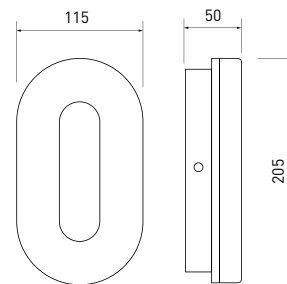

LED
TECHNOLOGY



10 W

3 years
warranty



LD-TWI10WOW-40	10 W	● 4000 K	750 lm	PC	czarny, black, черный, чорний	300 g	5902801042058
----------------	------	----------	--------	----	--	-------	---------------





PL Oprawa kanałowa LED z czujnikiem ruchu
 EN LED bulkhead fixture with motion sensor
 RU Светодиодный ЖКХ светильник с датчиком движения
 UK Світлодіодний ЖКГ світильник з датчиком руху



Technical & industrial
fixtures

360°

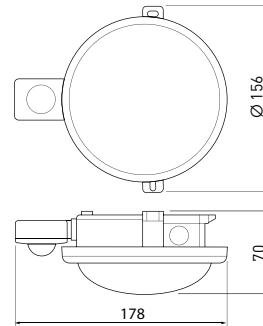

LD-DELOR6WC-NB

6 W

4000 K

400 lm

ABS / PC

biały, white,
белый, білий

207 g

5901867191106



PL Oprawa kanałowa LED z czujnikiem ruchu
 EN LED bulkhead fixture with motion sensor
 RU Светодиодный ЖКХ светильник с датчиком движения
 UK Світлодіодний ЖКГ світильник з датчиком руху



DELTA

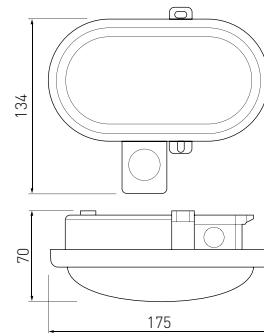

LD-DELOW6WC-NB

6 W

4000 K

400 lm

ABS / PC

biały, white,
белый, білий

207 g

5901867191113



PL Oprawa kanałowa LED
EN LED bulkhead fixture
RU Светодиодный ЖКХ светильник
UK Світлодіодний ЖКГ світильник

KODO

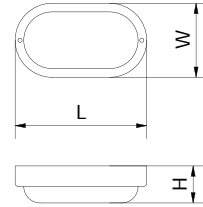

LD-KD08WOV-NB	8 W	● 4000 K	720 lm	PC	160 × 90 × 47	biała, white, белый, білий	220 g	5902801305269
LD-KD12WOV-NB	12 W		1080 lm		197 × 97 × 47		250 g	5902801304798



PL Oprawa kanałowa LED
EN LED bulkhead fixture
RU Светодиодный ЖКХ светильник
UK Світлодіодний ЖКГ світильник

KODO

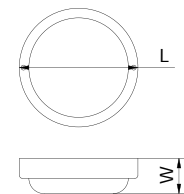

LD-KD08WOK-NB	8 W	● 4000 K	720 lm	PC	ø155 × 47	biała, white, белый, білий	240 g	5902801305276
LD-KD12WOK-NB	12 W		1080 lm		ø175 × 47		280 g	5902801305153





OPRAWY LED TYPU DOWNLIGHT
LED DOWNLIGHTS
СВЕТИЛЬНИКИ ТИПА DOWNLIGHT
СВІТИЛЬНИКИ ТИПУ DOWNLIGHT

PL Oprawa LED typu downlight wpuszczana
 EN Downlight LED fitting, flush mounted
 RU Светодиодный светильник типа downlight врезной
 UK Світлодіодний світильник типу downlight врізний



12-24 W



SORA

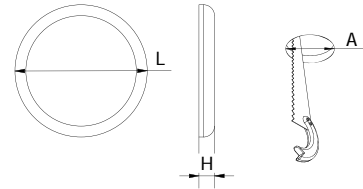
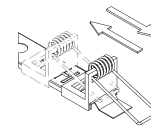

Model	Power (W)	Color (K)	Beam Angle (°)	Material	Ø (mm)	Ø (mm)	PF	Weight (g)	Barcode
LD-SRW12WOK-NB	12 W	● 4000 K	1200 lm	PC	ø120 × 28	ø75-105	PF > 0,5	220 g	5902801305498
LD-SRW18WOK-NB	18 W		1800 lm		ø170 × 28	ø75-155		320 g	5902801305979
LD-SRW24WOK-NB	24 W		2400 lm		ø225 × 28	ø75-205		500 g	5902801306075

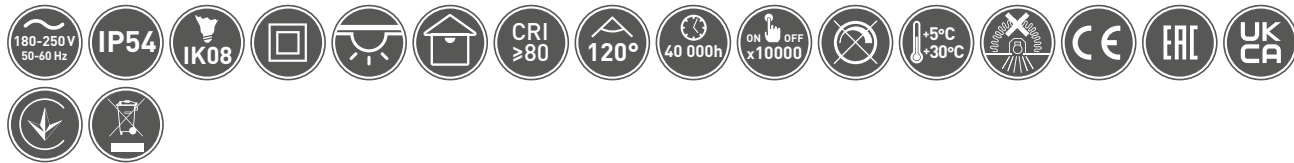

PL Oprawa LED typu downlight wpuszczana
 EN Downlight LED fitting, flush mounted
 RU Светодиодный светильник типа downlight врезной
 UK Світлодіодний світильник типу downlight врізний



12-24 W



SORA

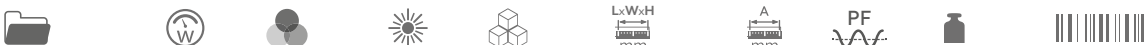
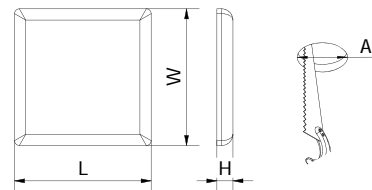
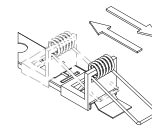

Model	Power (W)	Color (K)	Beam Angle (°)	Material	LxWxH (mm)	A (mm)	PF	Weight (g)	Barcode
LD-SRW12WKW-NB	12 W	● 4000 K	1200 lm	PC	120 × 120 × 20	ø75-105	PF > 0,5	250 g	5902801306082
LD-SRW18WKW-NB	18 W		1800 lm		170 × 170 × 20	ø75-155		390 g	5902801305672
LD-SRW24WKW-NB	24 W		2400 lm		225 × 225 × 20	ø75-205		600 g	5902801307263



PL Oprawa LED typu downlight natynkowa
 EN Surface mounted LED downlight
 RU Светодиодный накладной светильник downlight
 UK Світлодіодний світильник типу downlight поверхневого монтажу



inside
7-24 W

3
years
warranty

IP20

ORIS PLUS

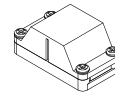

Accesoria,
 Accessories,
 Аксессуары,
 Аксессуары:
 LZ-KO12KO-10

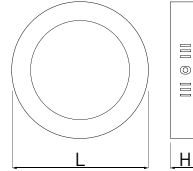

Technical & industrial
 fixtures



LD-ORN07W-CBP	7 W	● 3000 K	560 lm	aluminium, aluminium, алюминий, алюміній	ø120 x 32	PF > 0,5	340 g	5902801243080
LD-ORN07W-NBP		● 4000 K						5902801243271
LD-ORN13W-CBP	13 W	● 3000 K	1020 lm		ø170 x 32		490 g	5902801243486
LD-ORN13W-NBP		● 4000 K			5902801243028			
LD-ORN19W-CBP	19 W	● 3000 K	1520 lm		ø224 x 32		610 g	5902801242779
LD-ORN19W-NBP		● 4000 K			5902801243523			
LD-ORN24W-CBP	24 W	● 3000 K	2000 lm		ø303 x 32		1000 g	5902801243417
LD-ORN24W-NBP		● 4000 K						5902801243738

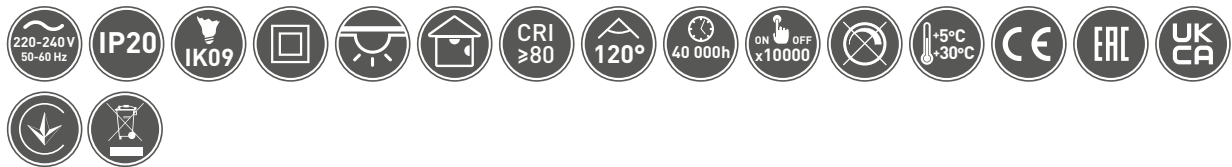

PL Oprawa LED typu downlight natynkowa
 EN Surface mounted LED downlight
 RU Светодиодный накладной светильник downlight
 UK Світлодіодний світильник типу downlight поверхневого монтажу

NEW



inside
7-24 W

3
years
warranty

IP20

ORIS PLUS

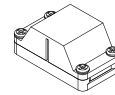

Accesoria,
 Accessories,
 Аксессуары,
 Аксессуары:
 LZ-KO12KO-10

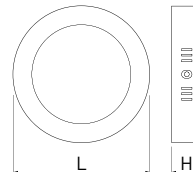

LD-ORN07W-CBP-10	7 W	● 3000 K	560 lm	aluminium, aluminium, алюминий, алюміній	ø120 x 32	PF > 0,5	340 g	5902801387920
LD-ORN07W-NBP-10		● 4000 K						5902801387814
LD-ORN13W-CBP-10	13 W	● 3000 K	1020 lm		ø170 x 32		490 g	5902801388019
LD-ORN13W-NBP-10		● 4000 K			5902801388279			
LD-ORN19W-CBP-10	19 W	● 3000 K	1520 lm		ø224 x 32		610 g	5902801388248
LD-ORN19W-NBP-10		● 4000 K			5902801399725			
LD-ORN24W-CBP-10	24 W	● 3000 K	2000 lm		ø303 x 32		1000 g	5902801388361
LD-ORN24W-NBP-10		● 4000 K						5902801388378

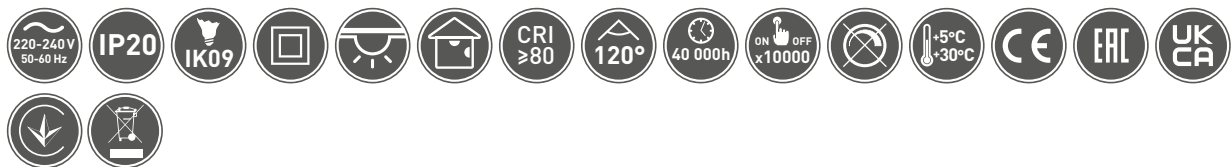

- PL Oprawa LED typu downlight wpuszczana
- EN Recessed LED downlight
- RU Светодиодный встраиваемый светильник downlight
- UK Світлодіодний світильник типу downlight врізний

ORIS PLUS

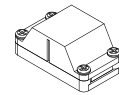

Aksesoria,
Accessories,
Аксессуары,
Аксесуари:
LZ-KOI2KO-10

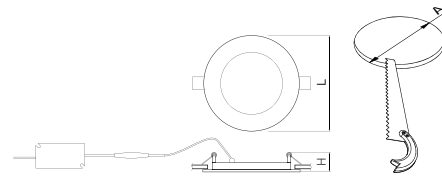

3-24 W

3 years warranty

IP20

	W	Color	lm	Material	LxH mm	A mm	PF	Weight	Barcode
LD-ORW03W-CBP	3 W	3000 K	200 lm	aluminium, aluminium, алюминий, алюміній	ø90 x 22	ø72-75	PF > 0,5	150 g	5902801243066
LD-ORW03W-NBP		4000 K							5902801243318
LD-ORW07W-CBP	7 W	3000 K	560 lm		ø118 x 22	ø105-108		220 g	5902801243073
LD-ORW07W-NBP		4000 K							5902801243165
LD-ORW13W-CBP	13 W	3000 K	1020 lm		ø168 x 22	ø153-156		350 g	5902801243035
LD-ORW13W-NBP		4000 K							5902801243042
LD-ORW19W-CBP	19 W	3000 K	1520 lm		ø225 x 22	ø204-206		550 g	5902801243578
LD-ORW19W-NBP		4000 K							5902801243134
LD-ORW24W-CBP	24 W	3000 K	2000 lm		ø300 x 22	ø275-280		880 g	5901867127624
LD-ORW24W-NBP		4000 K							5901867158390



Technical & industrial fixtures

- PL Oprawa LED typu downlight wpuszczana
- EN Recessed LED downlight
- RU Светодиодный встраиваемый светильник downlight
- UK Світлодіодний світильник типу downlight врізний

ORIS PLUS

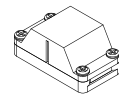

Aksesoria,
Accessories,
Аксессуары,
Аксесуари:
LZ-KOI2KO-10

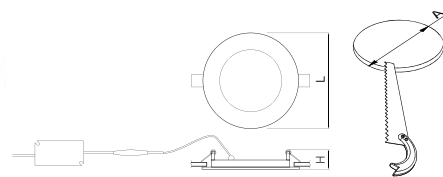

3-24 W

3 years warranty

IP44

	W	Color	lm	Material	LxH mm	A mm	PF	Weight	Barcode
LD-ORW03W-NBP4	3 W	3000 K	200 lm	aluminium, aluminium, алюминий, алюміній	ø90 x 22	ø72-75	PF > 0,5	150 g	5902801267390
LD-ORW03W-CBP4		4000 K							5902801267352
LD-ORW07W-CBP4	7 W	3000 K	560 lm		ø118 x 22	ø105-108		220 g	5902801266430
LD-ORW07W-NBP4I		4000 K							5902801396847
LD-ORW13W-CBP4	13 W	3000 K	1020 lm		ø168 x 22	ø153-156		350 g	5902801266058
LD-ORW13W-NBP4		4000 K							5902801266737
LD-ORW19W-CBP4	19 W	3000 K	1520 lm		ø225 x 22	ø204-206		550 g	5902801266362
LD-ORW19W-NBP4		4000 K							5902801266713
LD-ORW24W-CBP4	24 W	3000 K	2000 lm		ø300 x 22	ø275-280		880 g	5902801266478
LD-ORW24W-NBP4		4000 K							5902801266966

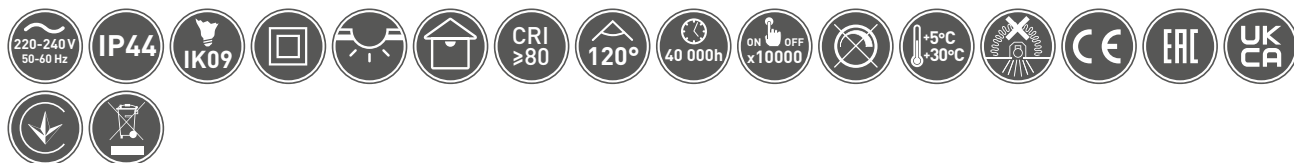

PL Oprawa LED wpuszczana
EN Flush-mounted LED fitting
RU Светодиодный светильник врезной
UK Світлодіодний світильник врізний

ORIS PLUS

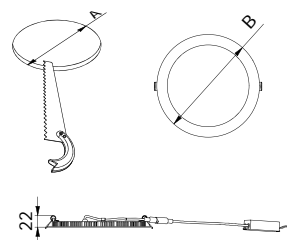

Technical & industrial fixtures

	W	Color	lm	Material	A	B	Weight	Barcode
LD-ORW07W-CBP-10	7 W	3000 K	560 lm	aluminium, aluminium, алюминий, алюміній	Ø 105-108	Ø118	220 g	5902801399749
LD-ORW07W-NBP-10		4000 K						5902801399770
LD-ORW13W-CBP-10	13 W	3000 K	1020 lm		Ø 153-156	Ø168	350 g	5902801387845
LD-ORW13W-NBP-10		4000 K						5902801387937
LD-ORW19W-CBP-10	19 W	3000 K	1520 lm		Ø 204-206	Ø225	550 g	5902801387913
LD-ORW19W-NBP-10		4000 K						5902801387586
LD-ORW24W-CBP-10	24 W	3000 K	2000 lm		Ø 275-280	Ø300	880 g	5902801387869
LD-ORW24W-NBP-10		4000 K						5902801387876



PL Oprawa LED typu downlight natynkowa
EN Surface mounted LED downlight
RU Светодиодный накладной светильник downlight
UK Світлодіодний світильник типу downlight поверхневого монтажу

MATIS PLUS

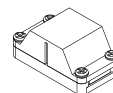

Акcesoria,
Accessories,
Аксессуары,
Акcesуари:
LZ-KO12KO-10

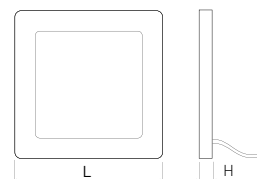

	W	Color	lm	Material	LxH mm	PF	Weight	Barcode
LD-MAN07W-CBP	7 W	3000 K	560 lm	aluminium, aluminium, алюминий, алюміній	120 x 32	PF > 0,5	340 g	5902801244186
LD-MAN07W-NBP		4000 K						5902801244087
LD-MAN13W-CBP	13 W	3000 K	1020 lm		170 x 32		490 g	5902801244179
LD-MAN13W-NBP		4000 K						5902801244445
LD-MAN19W-CBP	19 W	3000 K	1520 lm		223 x 32		750 g	5902801244452
LD-MAN19W-NBP		4000 K						5902801244414
LD-MAN24W-CBP	24 W	3000 K	2000 lm		300 x 32		1300 g	5902801243776
LD-MAN24W-NBP		4000 K						5902801243332

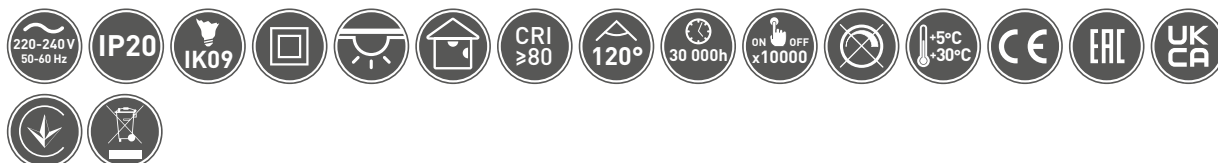

PL Oprawa LED typu downlight wpuszczana
EN Recessed LED downlight
RU Светодиодный встраиваемый светильник downlight
UK Світлодіодний світильник типу downlight врізний

MATIS PLUS

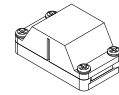

Aksesoria,
Accessories,
Аксессуары,
Аксесуари:
LZ-KOI2KO-10



3-24 W



IP20

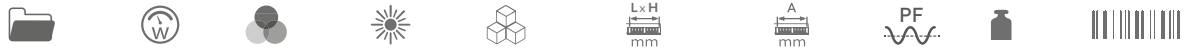
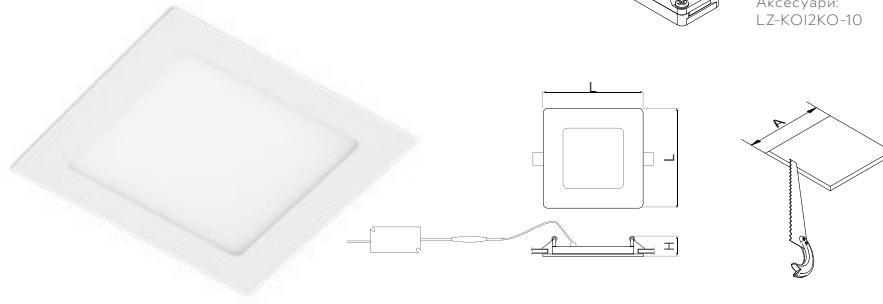

Model	Power (W)	Color Temperature (K)	Beam Angle (°)	Material	Dimensions (mm)	Height (mm)	Power Factor (PF)	Weight (g)	Barcode
LD-MAW03W-CBP	3 W	3000 K	200 lm	aluminium, aluminium, алюминий, алюміній	86 x 22	72-75	PF > 0,5	150 g	5902801243448
LD-MAW03W-NBP		4000 K							5902801243653
LD-MAW07W-CBP	7 W	3000 K	560 lm		120 x 22	102-105		240 g	5902801243721
LD-MAW07W-NBP		4000 K							5902801243615
LD-MAW13W-CBP	13 W	3000 K	1020 lm		170 x 22	152-155		400 g	5902801243462
LD-MAW13W-NBP		4000 K							5902801243912
LD-MAW19W-CBP	19 W	3000 K	1520 lm		224 x 22	202-205		640 g	5902801243639
LD-MAW19W-NBP		4000 K							5902801243981
LD-MAW24W-CBP	24 W	3000 K	2000 lm		300 x 22	275-280		1100 g	5902801244155
LD-MAW24W-NBP		4000 K							5902801244056

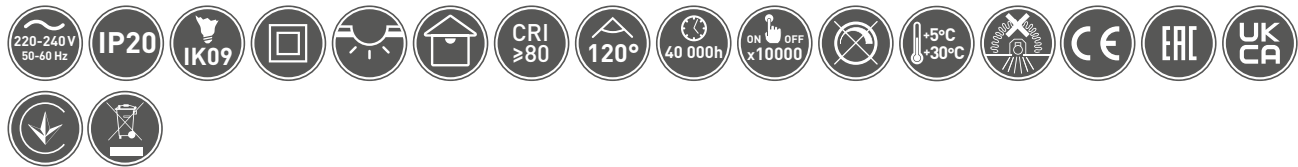

PL Oprawa LED typu downlight wpuszczana
EN Recessed LED downlight
RU Светодиодный встраиваемый светильник downlight
UK Світлодіодний світильник типу downlight врізний

MATIS PLUS

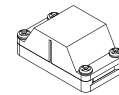

Aksesoria,
Accessories,
Аксессуары,
Аксесуари:
LZ-KOI2KO-10



3-24 W



IP44

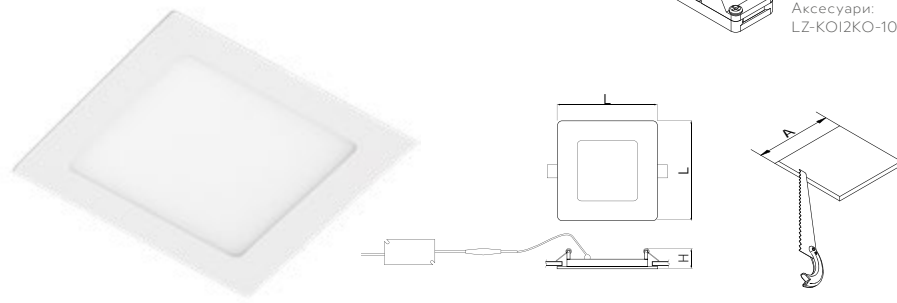

Model	Power (W)	Color Temperature (K)	Beam Angle (°)	Material	Dimensions (mm)	Height (mm)	Power Factor (PF)	Weight (g)	Barcode
LD-MAW03W-CBP4	3 W	3000 K	200 lm	aluminium, aluminium, алюминий, алюміній	86 x 22	72-75	PF > 0,5	150 g	5902801267123
LD-MAW03W-NBP4		4000 K							5902801267567
LD-MAW07W-CBP4	7 W	3000 K	560 lm		120 x 22	102-105		240 g	5902801266447
LD-MAW07W-NBP4		4000 K							5902801266768
LD-MAW13W-CBP4	13 W	3000 K	1020 lm		170 x 22	152-155		400 g	5902801266720
LD-MAW13W-NBP4		4000 K							5902801267215
LD-MAW19W-CBP4	19 W	3000 K	1520 lm		224 x 22	202-205		640 g	5902801266706
LD-MAW19W-NBP4		4000 K							5902801266553
LD-MAW24W-NBP4	24 W	3000 K	2000 lm		300 x 22	275-280		1100 g	5902801267406
LD-MAW24W-CBP4		4000 K							5902801266492

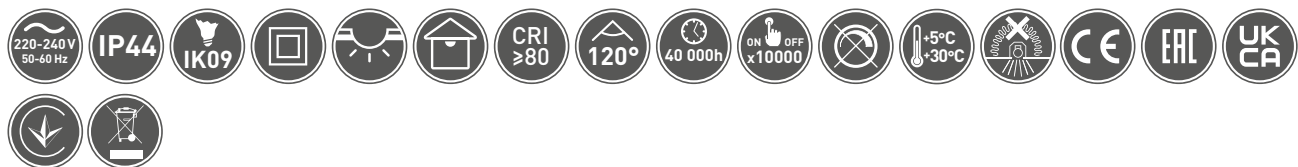

Technical & industrial fixtures



- PL Oprawa LED typu downlight natynkowa
- EN Surface mounted LED downlight
- RU Светодиодный накладной светильник downlight
- UK Світлодіодний світильник типу downlight поверхневого монтажу



12-18 W



Technical & industrial fixtures

MATIS PLUS

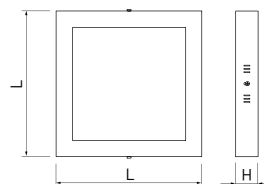

Model	Power (W)	Color Temperature (K)	Lumen (lm)	Material	Dimensions (mm)	Weight (g)	Barcode
LD-MAN07W-CBP-10	7 W	3000 K	560 lm	aluminium, aluminium, алюминий, алюміній	120 x 32	340g	5902801326752
LD-MAN07W-NBP-10		4000 K					5902801327162
LD-MAN13W-CBP-10	13 W	3000 K	1020 lm		170 x 32	490g	5902801327063
LD-MAN13W-NBP-10		4000 K					5902801333354
LD-MAN19W-CBP-10	19 W	3000 K	1520 lm		223 x 32	750g	5902801326714
LD-MAN19W-NBP-10		4000 K					5902801366949
LD-MAN24W-CBP-10	24 W	3000 K	2000 lm		300 x 32	1300g	5902801327285
LD-MAN24W-NBP-10		4000 K					5902801327346

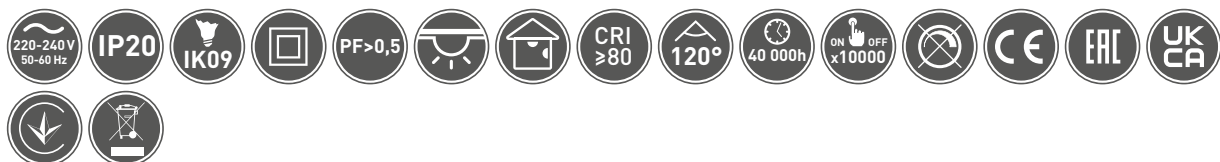

- PL Oprawa LED typu downlight wpuszczana
- EN Recessed LED downlight
- RU Светодиодный встраиваемый светильник downlight
- UK Світлодіодний світильник типу downlight врізний



12-18 W



MATIS PLUS

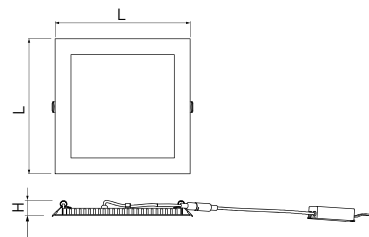

Model	Power (W)	Color Temperature (K)	Lumen (lm)	Material	Dimensions (mm)	Weight (g)	Barcode	
LD-MAW07W-CBP-10	7 W	3000 K	560 lm	aluminium, aluminium, алюминий, алюміній	120 x 22	102-105	240g	5902801266447
LD-MAW07W-NBP-10		4000 K						5902801266768
LD-MAW13W-CBP-10	13 W	3000 K	1020 lm		170 x 22	152-155	400g	5902801266720
LD-MAW13W-NBP-10		4000 K						5902801267215
LD-MAW19W-CBP-10	19 W	3000 K	1520 lm		224 x 22	202-205	640g	5902801266706
LD-MAW19W-NBP-10		4000 K						5902801266553
LD-MAW24W-CBP-10	24 W	3000 K	2000 lm		300 x 22	275-280	1100g	5902801267406
LD-MAW24W-NBP-10		4000 K						5902801266492

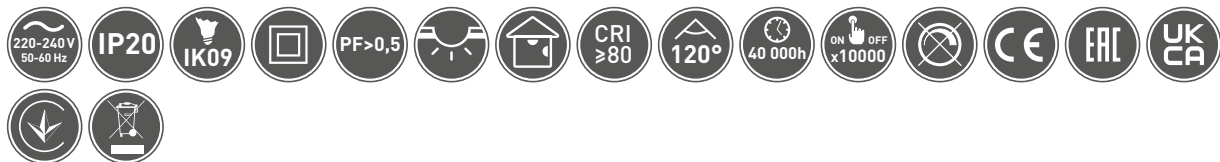

PL Oprawa LED typu downlight
EN Surface mounted LED downlight
RU Светодиодный светильник downlight
UK Світлодіодний світильник типу downlight

MOZA

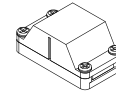

Aksesoria,
Accessories,
Аксессуары,
Аксесуари:
LZ-KOI2KO-10

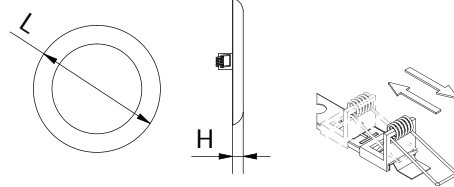

LD-MZ12WOK-NB	12 W	● 4000 K	1000 lm	PC	ø180 × 16	ø65-155 mm	300 g	5902801229497
LD-MZ18WOK-NB	18 W		1500 lm		ø230 × 16	ø65-205 mm	390 g	5902801229329



PL Oprawa LED typu downlight
EN Surface mounted LED downlight
RU Светодиодный светильник downlight
UK Світлодіодний світильник типу downlight

MOZA

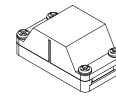

Aksesoria,
Accessories,
Аксессуары,
Аксесуари:
LZ-KOI2KO-10

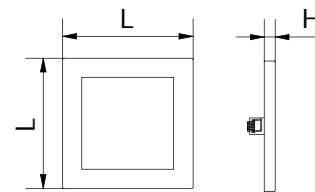

LD-MZ12WKW-NB	12 W	● 4000 K	1000 lm	PC	180 × 16	ø65-155 mm	480 g	5902801229510
LD-MZ18WKW-NB	18 W		1500 lm		230 × 16	ø65-205 mm	570 g	5902801229428



PL Oprawa LED typu downlight natynkowa
 EN Surface mounted LED downlight
 RU Светодиодный накладной светильник downlight
 UK Світлодіодний світильник типу downlight поверхневого монтажу

LOUIS

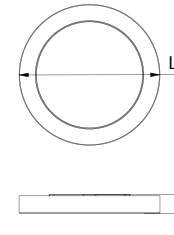

Technical & industrial
fixtures



LD-LSNO06W-NB	6 W	● 4000 K	480 lm	aluminium, aluminium, алюминий, алюміній	ø120 × 28	PF > 0,5	98 g	5902801226366
LD-LSNO12W-NB	12 W		960 lm		ø170 × 28		155 g	5902801226090
LD-LSNO24W-NB	24 W		1920 lm		ø225 × 28		274 g	5902801225819

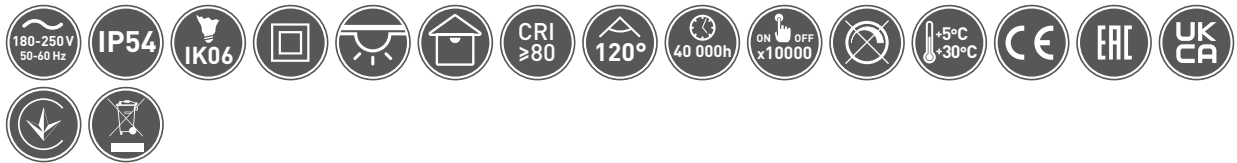

PL Oprawa LED typu downlight natynkowa
 EN Surface mounted LED downlight
 RU Светодиодный накладной светильник downlight
 UK Світлодіодний світильник типу downlight поверхневого монтажу

LOUIS

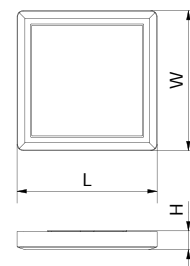

LD-LSNK06W-NB	6 W	● 4000 K	480 lm	aluminium, aluminium, алюминий, алюміній	120 × 120 × 28	PF > 0,5	98 g	5902801226229
LD-LSNK12W-NB	12 W		960 lm		170 × 170 × 28		155 g	5902801226076
LD-LSNK24W-NB	24 W		1920 lm		225 × 225 × 28		274 g	5902801226533





PL Oprawa LED typu downlight wpuszczana
 EN Recessed LED downlight
 RU Светодиодный встраиваемый светильник downlight
 UK Світлодіодний світильник типу downlight врізний

LOUIS

Technical & industrial
fixtures

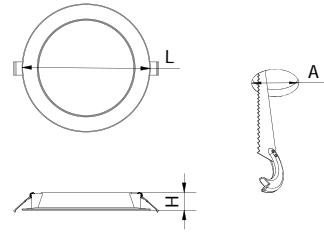

LD-LSWO03W-NB	3 W	● 4000 K	240 lm	PC	ø90 × 24	ø75	PF > 0,5	51 g	5902801226113
LD-LSWO06W-NB	6 W		480 lm		ø90 × 24	ø75		54 g	5902801226397
LD-LSWO15W-NB	15 W		1200 lm		ø150 × 24	ø135		133 g	5902801226373
LD-LSWO24W-NB	24 W		1920 lm		ø225 × 24	ø206		245 g	5902801225949



PL Oprawa LED typu downlight wpuszczana
 EN Recessed LED downlight
 RU Светодиодный встраиваемый светильник downlight
 UK Світлодіодний світильник типу downlight врізний

LOUIS

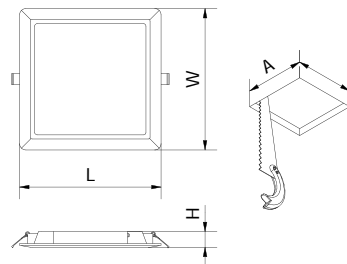

LD-LSWK03W-NB	3 W	● 4000 K	240 lm	PC	86 × 86 × 24	75	PF > 0,5	53 g	5902801226205
LD-LSWK06W-NB	6 W		480 lm		86 × 86 × 24	75		60 g	5902801225956
LD-LSWK15W-NB	15 W		1200 lm		150 × 150 × 24	135		148 g	5902801226427
LD-LSWK24W-NB	24 W		1920 lm		225 × 225 × 24	206		280 g	5902801226410



PL Oprawa LED typu downlight 2 w 1 natynkowa/wpuszczana
 EN LED downlight fixture 2 in 1 surface mounted/recessed
 RU Светодиодный светильник 2 в 1 накладной / встраиваемый
 UK Світлодіодний світильник типу downlight 2 в 1 поверхневий/врізний



7-20 W



SAMBA

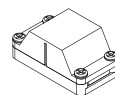

Aksesoria,
Accessories,
Аксессуары,
Аксесуари:
LZ-KOI2KO-10

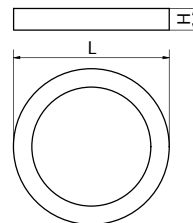

Model	Power (W)	Color Temp (K)	Lumen (lm)	Material	Dimensions (mm)	Power Factor (PF)	Weight (g)	Barcode
LD-SMBOK07W-21	7 W	● 4000 K	675 lm	PC	ø115 × 35	PF > 0,5	150 g	5902801240362
LD-SMBOK14W-21	14 W		1200 lm		ø177 × 35		300 g	5902801239946
LD-SMBOK20W-21	20 W		1600 lm		ø245 × 35		515 g	5902801073328



PL Oprawa LED typu downlight 2 w 1 natynkowa/wpuszczana
 EN LED downlight fixture 2 in 1 surface mounted/recessed
 RU Светодиодный светильник 2 в 1 накладной / встраиваемый
 UK Світлодіодний світильник типу downlight 2 в 1 поверхневий/врізний



9-24 W



SAMBA

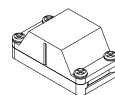
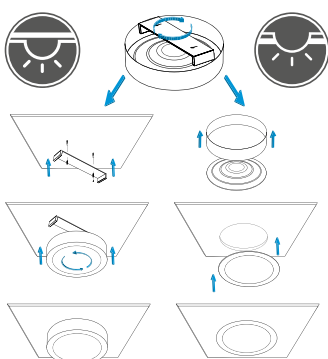

Aksesoria,
Accessories,
Аксессуары,
Аксесуари:
LZ-KOI2KO-10

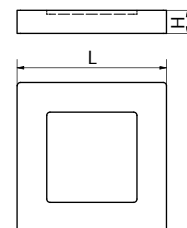

Model	Power (W)	Color Temp (K)	Lumen (lm)	Material	Dimensions (mm)	Power Factor (PF)	Weight (g)	Barcode
LD-SMBKW07W-21	9 W	● 4000 K	675 lm	PC	115 × 35	PF > 0,5	180 g	5902801239908
LD-SMBKW14W-21	16 W		1200 lm		171 × 35		365 g	5902801239861
LD-SMBKW24W-21	24 W		1800 lm		226 × 35		565 g	5902801073304



PL Oprawa LED typu downlight 2 w 1 natynkowa/wpuszczana
 EN LED downlight fixture 2 in 1 surface mounted/recessed
 RU Светодиодный светильник 2 в 1 накладной / встраиваемый
 UK Світлодіодний світильник типу downlight 2 в 1 поверхневий/врізний

BOLERO

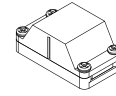

Aksesoria,
Accessories,
Аксесуари,
Аксессуары:
LZ-KO12KO-10

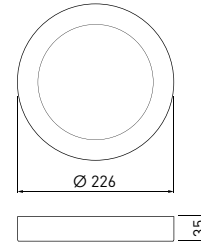

LED
TECHNOLOGY



18 W



TRI-COLOR



Technical & industrial
fixtures



LD-BLROK18W-61	18 W	<ul style="list-style-type: none"> ● 3000 K ● 4000 K ● 6400 K 	1600 lm	aluminium + PC, aluminium + PC, алюминий + PC, алюміній + PC	560 g	5902801020117
----------------	------	--	---------	---	-------	---------------



PL Oprawa LED typu downlight 2 w 1 natynkowa/wpuszczana
 EN LED downlight fixture 2 in 1 surface mounted/recessed
 RU Светодиодный светильник 2 в 1 накладной / встраиваемый
 UK Світлодіодний світильник типу downlight 2 в 1 поверхневий/врізний

BOLERO

360°

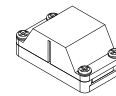

Aksesoria,
Accessories,
Аксесуари,
Аксессуары:
LZ-KO12KO-10

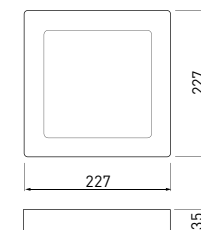

LED
TECHNOLOGY



18 W



TRI-COLOR



LD-BLRKW18W-61	18 W	<ul style="list-style-type: none"> ● 3000 K ● 4000 K ● 6400 K 	1600 lm	aluminium + PC, aluminium + PC, алюминий + PC, алюміній + PC	475 g	5902801020100
----------------	------	--	---------	---	-------	---------------



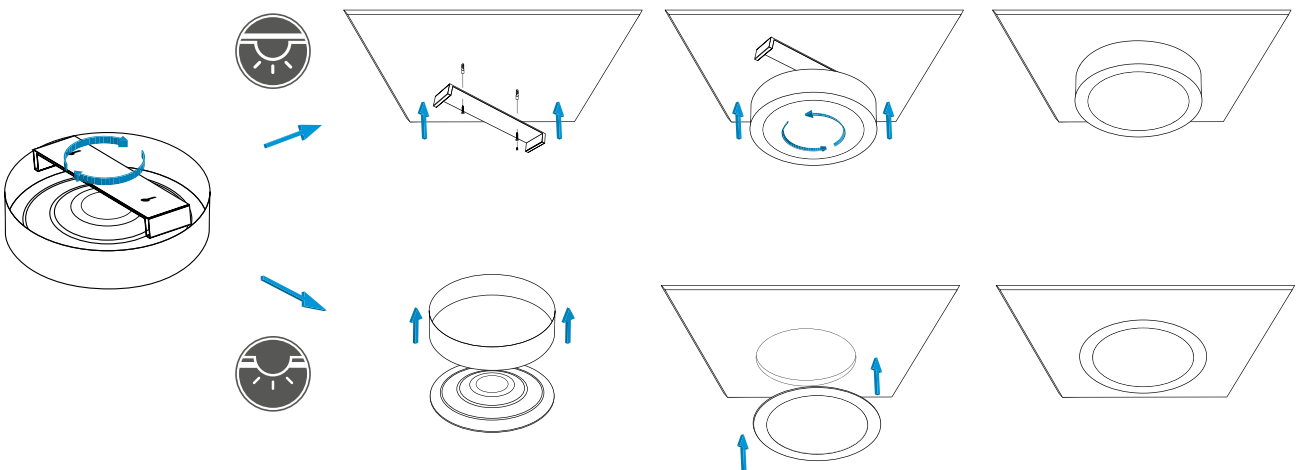
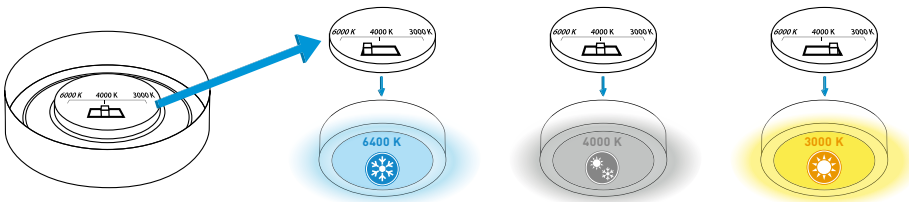
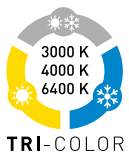

- PL Oprawa LED typu downlight natynkowa
- EN Surface mounted LED downlight
- RU Светодиодный накладной светильник downlight
- UK Світлодіодний світильник типу downlight поверхневого монтажу

TWINS

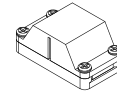
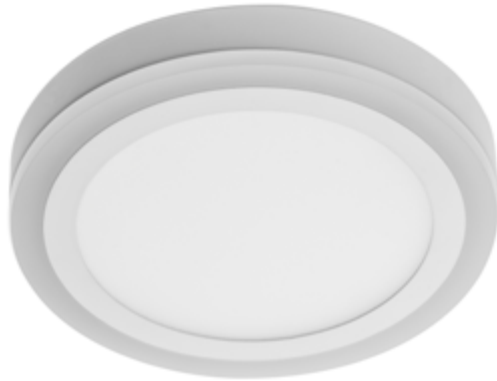

Aksesoria,
Accessories,
Аксессуары,
Аксесуари:
LZ-KO12KO-10

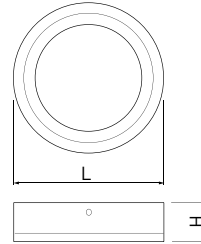

Technical & industrial fixtures



LD-TWN09W-CB	9 W (6W+3W)	3000 K	640 lm	aluminium + PC, aluminium + PC, алюминий + PC, алюміній + PC	ø147 × 37	290 g	5901867191045
LD-TWN16W-CB	16 W (12W+4W)		1140 lm		ø195 × 37	480 g	5901867191052

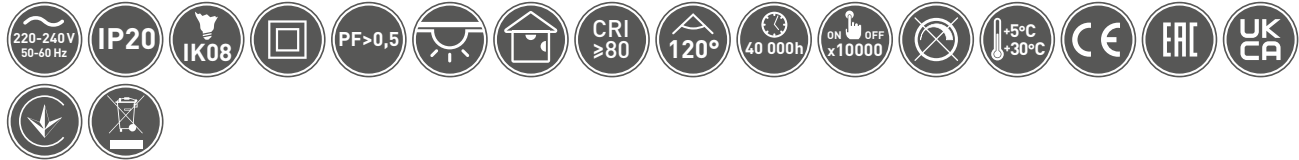

- PL Oprawa LED typu downlight wpuszczana
- EN Recessed LED downlight
- RU Светодиодный встраиваемый светильник downlight
- UK Світлодіодний світильник типу downlight врізний

TWINS

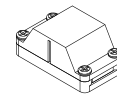

Aksesoria,
Accessories,
Аксессуары,
Аксесуари:
LZ-KO12KO-10

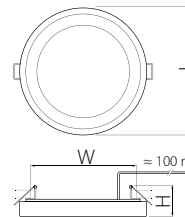

LD-TWW09W-CB	9 W (6W+3W)	3000 K	640 lm	aluminium + PC, aluminium + PC, алюминий + PC, алюміній + PC	ø145 × 130 × 30	200 g	5901867191069
LD-TWW16W-CB	16 W (12W+4W)		1140 lm		ø190 × 175 × 30	324 g	5901867191076

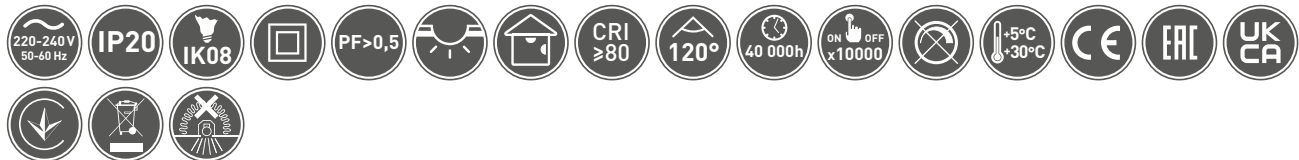

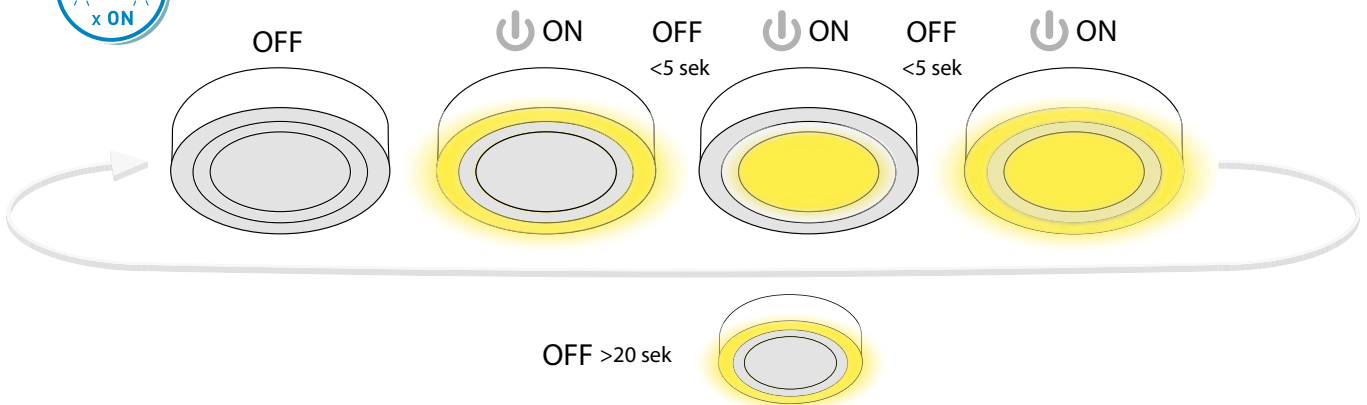

PL Oprawa LED typu downlight wpuszczana
EN Recessed LED downlight
RU Светодиодный встраиваемый светильник downlight
UK Світлодіодний світильник типу downlight врізний

VOLARE

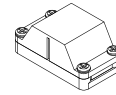

Accesoria,
Accessories,
Аксессуары,
Аксесуари:
LZ-KO12KO-10

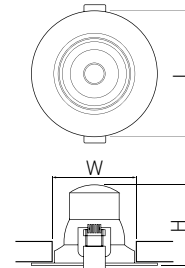

Product Code	Power (W)	Color Temperature (K)	Beam Angle (°)	Light Output (lm)	Dimensions (mm)	Material	Weight (g)	Barcode
LD-VLROK0538-CB	5 W	3000 K	38°	400 lm	ø90 × 75 × 45	PC	75 g	5902801015830
LD-VLROK0538-NB		4000 K						5902801299254
LD-VLROK1038-CB	10 W	3000 K	38°	800 lm	ø104 × 80 × 60		120 g	5902801015885
LD-VLROK1038-NB		4000 K						5902801299438

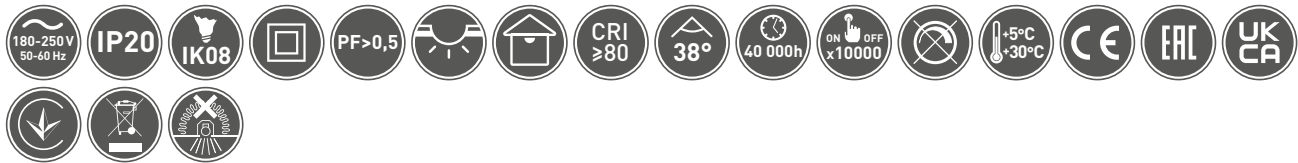

PL Oprawa LED typu downlight wpuszczana
EN Recessed LED downlight
RU Светодиодный встраиваемый светильник downlight
UK Світлодіодний світильник типу downlight врізний

VOLARE

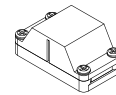

Accesoria,
Accessories,
Аксессуары,
Аксесуари:
LZ-KO12KO-10

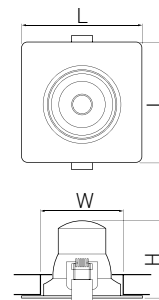

Product Code	Power (W)	Color Temperature (K)	Beam Angle (°)	Light Output (lm)	Dimensions (mm)	Material	Weight (g)	Barcode
LD-VLRKW0538-CB	5 W	3000 K	38°	400 lm	90 × 75 × 45	PC	75 g	5902801015823
LD-VLRKW0538-NB		4000 K						5902801299063
LD-VLRKW1038-CB	10 W	3000 K	38°	800 lm	104 × 80 × 60		120 g	5902801015854
LD-VLRKW1038-NB		4000 K						5902801299353

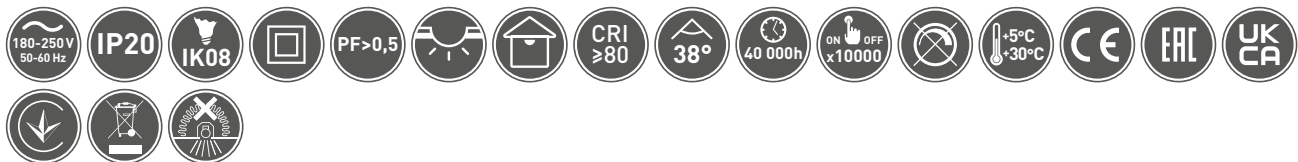

PL Oprawa LED typu downlight wpuszczana
EN Recessed LED downlight
RU Светодиодный встраиваемый светильник downlight
UK Світлодіодний світильник типу downlight врізний

VOLARE CCT

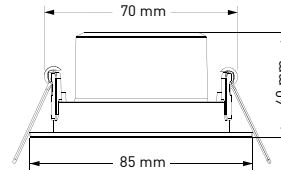

LD-VLROK0738-CCT	7 W	<ul style="list-style-type: none"> ● 3000 K ● 4000 K ● 6400 K 	630 lm	PC	100 g	5902801373060
------------------	-----	--	--------	----	-------	---------------

Technical & industrial fixtures

PL Oprawa LED typu downlight wpuszczana
EN Recessed LED downlight
RU Светодиодный встраиваемый светильник downlight
UK Світлодіодний світильник типу downlight врізний

VOLARE CCT

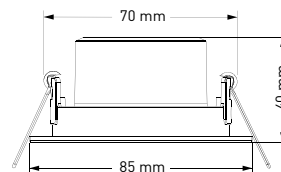

LD-VLRKW0738-CCT	7 W	<ul style="list-style-type: none"> ● 3000 K ● 4000 K ● 6400 K 	630 lm	PC	100 g	5902801373107
------------------	-----	--	--------	----	-------	---------------

PL Oprawa LED typu downlight wpuszczana
 EN Recessed LED downlight
 RU Светодиодный встраиваемый светильник downlight
 UK Світлодіодний світильник типу downlight врізний

DENVER

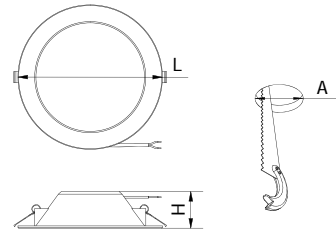

Technical & industrial
fixtures



	W				LxH mm	A mm	PF		
LD-DNV15W-NB	15 W	● 4000 K	1350 lm	PC	ø138 x 54	ø105	PF > 0,5	141 g	5902801226052
LD-DNV20W-NB	20 W		1800 lm		ø175 x 54	ø142		212 g	5902801226014
LD-DNV30W-NB	30 W		2700 lm		ø225 x 54	ø180	PF > 0,9	331 g	5902801226182



PL Oprawa LED typu downlight wpuszczana
 EN Recessed LED downlight
 RU Светодиодный встраиваемый светильник downlight
 UK Світлодіодний світильник типу downlight врізний

AREZZO

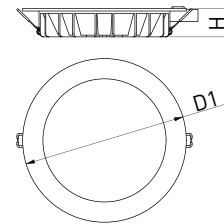

	W				LxH mm		
LD-ARZ18W-CCT	18 W	● 3000 K ● 4000 K ● 6400 K	1800 lm	aluminium, aluminium, алюминий, алюміній	ø145 x 30	500 g	5902801281884
LD-ARZ25W-CCT	25 W		2500 lm		ø190 x 30	525 g	5902801278112
LD-ARZ35W-CCT	35 W		3500 lm		ø225 x 30	660 g	5902801278136





PL Oprawa LED typu downlight natynkowa
 EN Surface mounted LED downlight
 RU Светодиодный накладной светильник downlight
 UK Світлодіодний світильник типу downlight поверхневого монтажу

KARIS

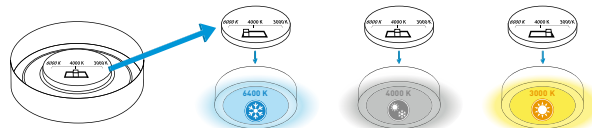
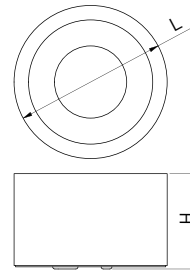

18-25 W



TRI-COLOR



Technical & industrial
fixtures



LD-KAR18W-CCT	18 W	● 3000 K ● 4000 K ● 6400 K	1800 lm	aluminium, aluminium, алюминий, алюміній	ø170 x 124	940 g	5902801210013
LD-KAR25W-CCT	25 W		2500 lm		ø212 x 132	960 g	5902801210044

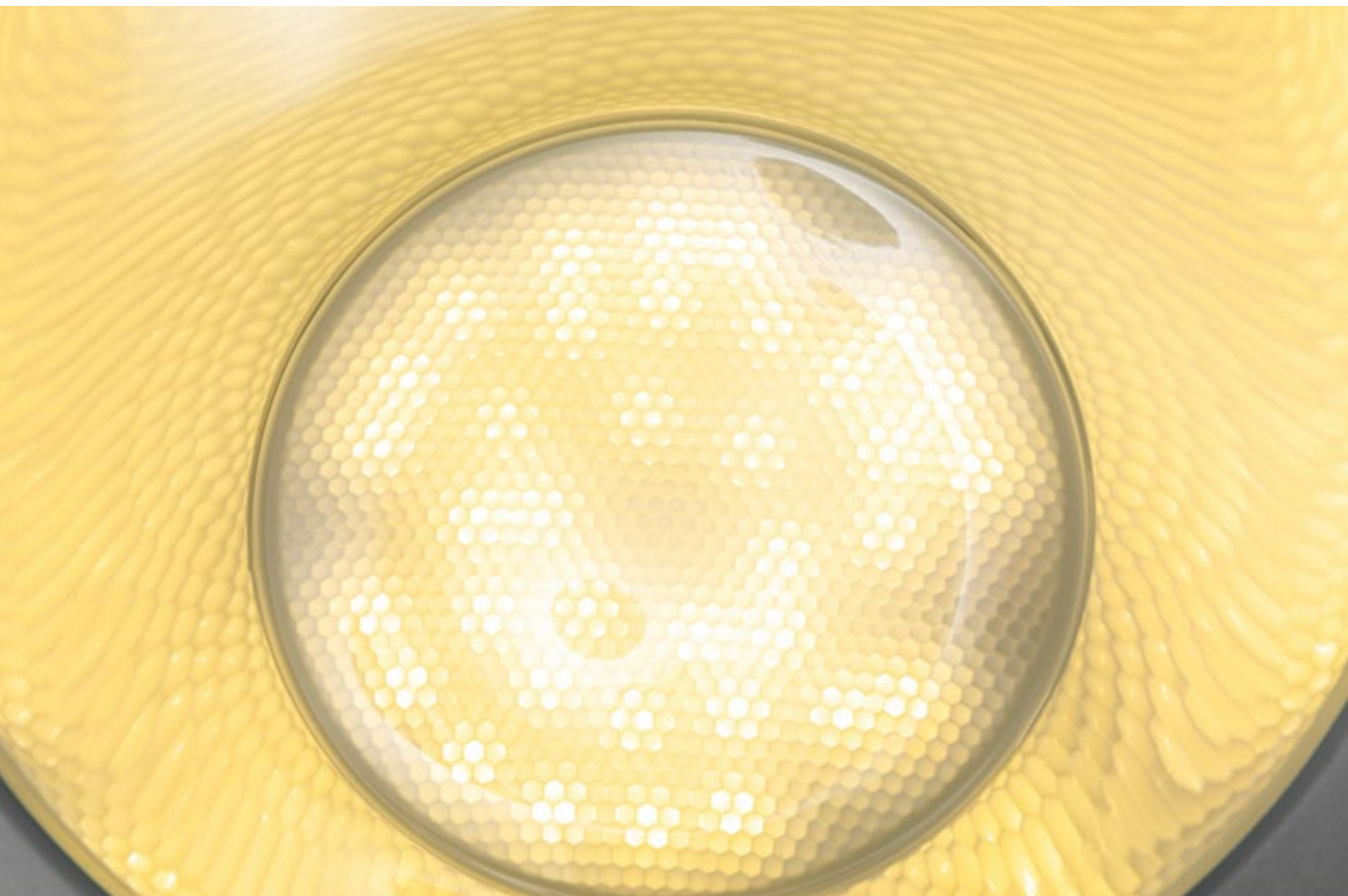

- PL Oprawa LED typu downlight natynkowa
- EN Surface mounted LED downlight
- RU Светодиодный накладной светильник downlight
- UK Світлодіодний світильник типу downlight поверхневого монтажу

ARCCO

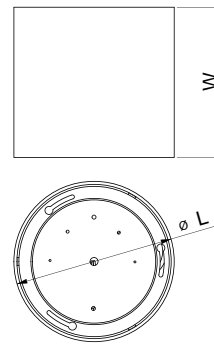

15-30 W



Technical & industrial
fixtures



Folder	W	Color	Light	LxW mm	Material	Weight	Barcode
LD-ARC15W-NB	15 W	● 4000 K	1350 lm	ø130 × 100	aluminium, aluminium, алюминий, алюміній	500 g	5902801278679
LD-ARC25W-NB	25 W		2250 lm	ø160 × 115		520 g	5902801278778
LD-ARC30W-NB	30 W		2700 lm	ø195 × 130		1000 g	5902801278747





NAŚWIETLACZE LED
LED FLOODLIGHTS
СВЕТОДИОДНЫЕ ПРОЖЕКТОРЫ
СВІТЛОДІОДНІ ПРОЖЕКТОРИ

PL Naświetlacz LED
EN LED floodlight
RU Светодиодный прожектор
UK Світлодіодний прожектор

DAYTONA

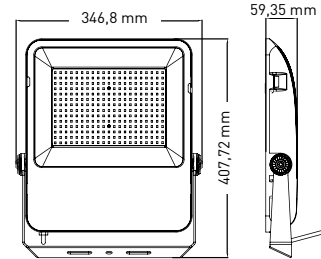

LD-DA200W-40	200 W	24000 lm	aluminium + szkło, aluminium + glass, алюминий + стекло, алюміній + скло	czarny, black, черный, чорний	4640 g	5902801327384
--------------	-------	----------	---	--	--------	---------------



PL Naświetlacz LED
EN LED floodlight
RU Светодиодный прожектор
UK Світлодіодний прожектор

VIPER

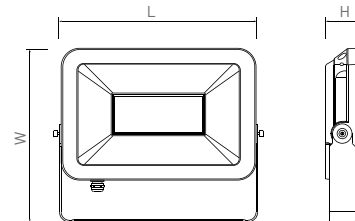

PL Naświetlacz LED
EN LED floodlight
RU Светодиодный прожектор
UK Світлодіодний прожектор

VIPER



LD-VIPERS30W-40	30 W	● 4000 K	2700 lm	aluminium + szkło, aluminium + glass, алюминий + стекло, алюміній + скло	198 x 191 x 34	czarny, black, черный, чорний	860 g	5902801266195
LD-VIPERS50W-40	50 W		4500 lm		229 x 214 x 35		1150 g	5902801266263
LD-VIPERS100W-40	100 W		10000 lm		306 x 268 x 58		2200 g	5902801251764
LD-VIPERS150W-40	150 W		15000 lm		367 x 315 x 72		3500 g	5902801251771

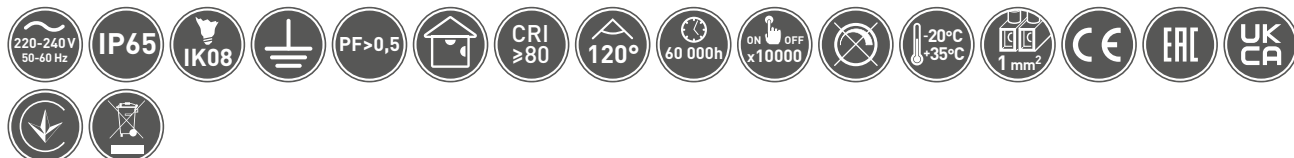

Technical & industrial
fixtures

PL Naświetlacz LED z czujnikiem ruchu
EN LED floodlight with motion sensor
RU Светодиодный прожектор с датчиком движения
UK Світлодіодний прожектор з датчиком руху

iNEXT

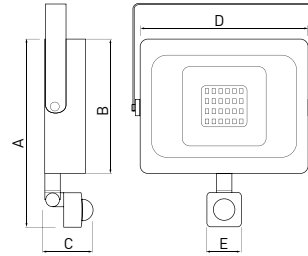

Technical & industrial fixtures



					A × B × C × D × E (mm)			
LD-INEXT10W-64	10 W	6400 K	800 lm	aluminium + szkło, aluminium + glass, алюминий + стекло, алюміній + скло	150 × 88 × 50 × 110 × 40	czarny, black, черный, чорний	250 g	5902801007682
LD-INEXT20W-64	20 W		1600 lm		180 × 120 × 50 × 160 × 40		500 g	5902801007699
LD-INEXT30W-64	30 W		2400 lm		180 × 120 × 50 × 160 × 40		800 g	5902801007705
LD-INEXT50W-64	50 W		4000 lm		210 × 145 × 50 × 190 × 40		1200 g	5902801007712

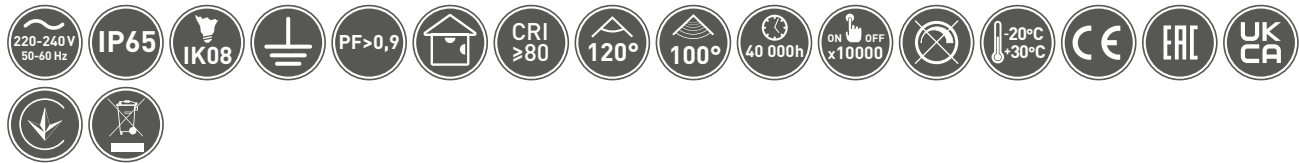

PL Naświetlacz LED
EN LED floodlight
RU Светодиодный прожектор
UK Світлодіодний прожектор

iNEXT

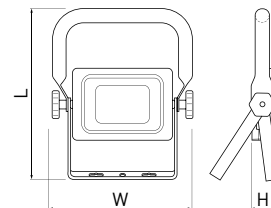

					L×W×H mm			
LD-INEXT30WP-64	30 W	6400 K	2400 lm	aluminium + szkło, aluminium + glass, алюминий + стекло, алюміній + скло	247 × 218 × 38	czarny, black, черный, чорний	800 g	5902801007729
LD-INEXT50WP-64	50 W		4000 lm		270 × 256 × 38		1200 g	5902801007736

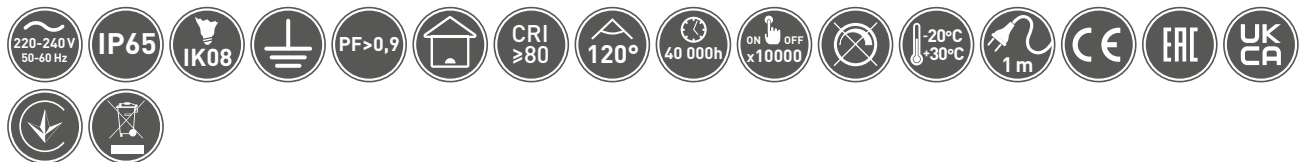



PL Naświetlacz LED
EN LED floodlight
RU Светодиодный прожектор
UK Світлодіодний прожектор

iLUX

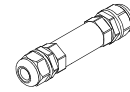

Aksesoria,
Accessories,
Аксессуары,
Аксесуари:
WZL-2

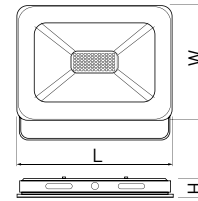

LED
TECHNOLOGY



10-50 W



Technical & industrial
fixtures



LD-ILUXC10W-64	10 W	6400 K	800 lm	>0,5	PC + szkło, PC + glass, PC + стекло, PC + скло	128 x 92 x 31	biały, white, белый, білий	160 g	5901867191267
LD-ILUXCC10W-64							czarny, black, черный, чорний		5902801005268
LD-ILUXC20W-64	20 W	6400 K	1600 lm	>0,5	PC + szkło, PC + glass, PC + стекло, PC + скло	170 x 130 x 36	biały, white, белый, білий	470 g	5901867191243
LD-ILUXCC20W-64							czarny, black, черный, чорний		5902801005282
LD-ILUXC30W-64I	30 W	6400 K	2400 lm	>0,9	PC + szkło, PC + glass, PC + стекло, PC + скло	230 x 170 x 36	biały, white, белый, білий	780 g	5902801046865
LD-ILUXCC30W-64							czarny, black, черный, чорний		5902801005305
LD-ILUXC50W-64	50 W	6400 K	4000 lm	>0,9	PC + szkło, PC + glass, PC + стекло, PC + скло	300 x 220 x 36	biały, white, белый, білий	1230 g	5901867191229
LD-ILUXCC50W-64							czarny, black, черный, чорний		5902801005329



PL Naświetlacz LED
EN LED floodlight
RU Светодиодный прожектор
UK Світлодіодний прожектор

iLUX

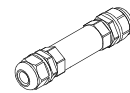

Aksesoria,
Accessories,
Аксессуары,
Аксесуари:
WZL-2

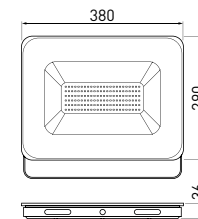

LED
TECHNOLOGY



100 W



LD-ILUXC100W-64	100 W	6400 K	8000 lm	PC + szkło, PC + glass, PC + стекло, PC + скло	380 x 290 x 36	biały, white, белый, білий	2000 g	5901867191267
LD-ILUXCC100W-64						czarny, black, черный, чорний		5901867191243



PL Naświetlacz LED
EN LED floodlight
RU Светодиодный прожектор
UK Світлодіодний прожектор

ALLEDO

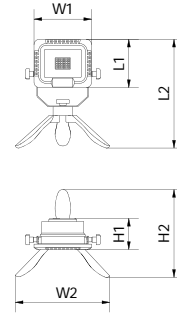

10-20 W



							L1xL2xW1xW2xH1xH2 mm			
LD-ALCX10W-64	10 W	6400 K	800lm	-	Li-ion 4000 mAh 3,7 V	PC + szkło, PC + glass, PC + стекло, PC + скло	87x228x108x213x58x180	zielony, green, зеленый, зелений	390 g	5902801330292
LD-ALCX20W-64*	20 W		1600lm	>0,5	Li-ion 4000 mAh 7,4 V		109x250x129x213x72x180		570 g	5902801330230



PL Naświetlacz LED
EN LED floodlight
RU Светодиодный прожектор
UK Світлодіодний прожектор

ONYX

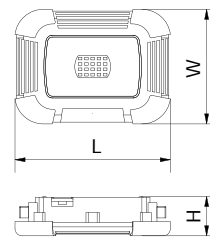

10-20 W



						LxWxH mm			
LD-OXCX10W-64	10 W	6400 K	800lm	Li-ion 4400 mAh 3,7 V	PC + szkło, PC + glass, PC + стекло, PC + скло	173 x 128 x 44	niebieski, blue, синий, синий	370 g	5902801343889
LD-OXCX20W-64	20 W		1600lm	Li-ion 8800 mAh 3,7 V				550 g	5902801330490



Technical & industrial fixtures



OPRAWY LED TYPU HIGH BAY
HIGH BAY LED LUMINAIRES
СВЕТОДИОДНЫЕ HIGH BAY СВЕТИЛЬНИКИ
СВІТЛОДІОДНІ HIGH BAY СВІТИЛЬНИКИ

PL High-bay LED
EN High-bay LED fixture
RU Светодиодный светильник High Bay
UK Світлодіодний світильник High Bay

TEKSAS

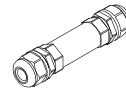
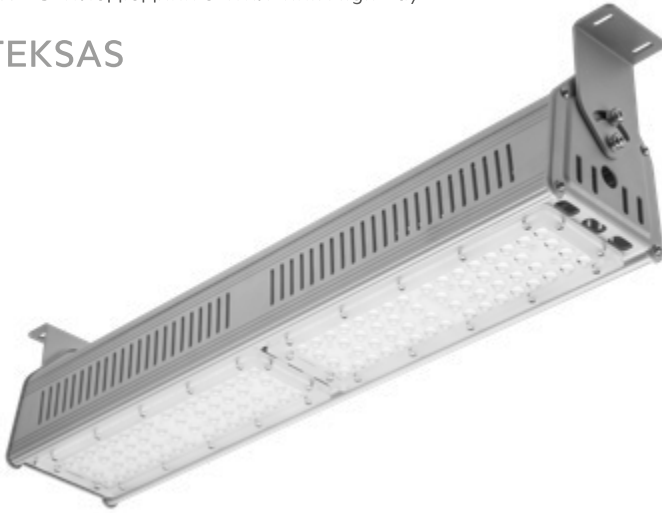

Aksesoria,
Accessories,
Аксессуары,
Аксесуари:
WZL-2

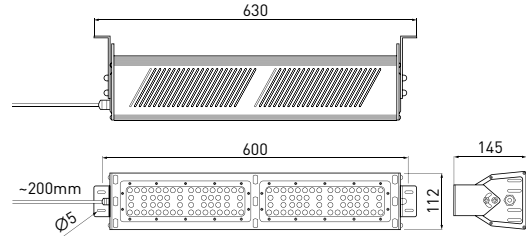

LD-TK100W-40	100 W	● 4000 K	12 000 lm	aluminium, aluminium, алюминий, алюміній	szary, grey, серый, сірий	3000 g	5902801001970
--------------	-------	----------	-----------	---	------------------------------	--------	---------------



Technical & industrial
fixtures



PL Soczewki wymienne
EN Replaceable lenses
RU Сменные линзы
UK Замінні лінзи



SO-TK060DE-00	60° x 60°	5902801008979
SO-TK090DE-00	90° x 90°	5902801008986
SO-TK612DE-00	60° x 120°	5902801008962
SO-TK069DE-00	60° x 90°	5902801024931

PL High-bay LED
EN High-bay LED fixture
RU Светодиодный светильник High Bay
UK Світлодіодний світильник High Bay

ARIZONA

Technical & industrial
fixtures

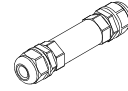

Aksesoria,
Accessories,
Аксесуари,
Аксесуари:
WZL-2

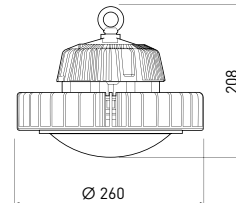

LED
TECHNOLOGY

Made
outside

150 W

7 years
warranty



LD-HB150W-40	150 W	● 4000 K	18000 lm	aluminium, aluminium, алюминий, алюміній	4500 g	5901867166432
--------------	-------	----------	----------	--	--------	---------------

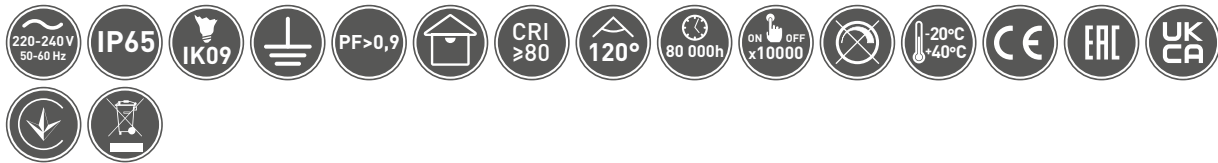

PL Reflektor do High-bay Arizona
EN Reflector for High-bay Arizona
RU Рефлектор для High-bay Arizona
UK Рефлектор для High-bay Arizona

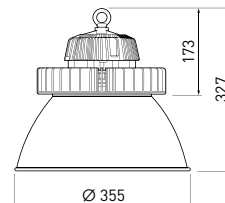

LED
TECHNOLOGY

Made
outside



RF-HB150W-40	aluminium, aluminium, алюминий, алюміній	szary, grey, серый, сірий	750 g	5901867170583
--------------	--	---------------------------	-------	---------------





PL High-bay LED
EN High-bay LED fixture
RU Светодиодный светильник High Bay
UK Світлодіодний світильник High Bay

KANSAS

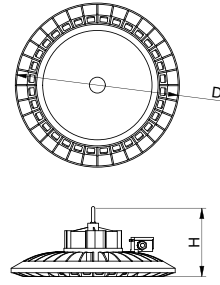

Technical & industrial
fixtures



LD-KAN150W-NB	150 W	● 4000 K	19500 lm	aluminium, aluminium, алюминий, алюминій	czarny, black, черный, білий	ø330 x 168	2700 g	5902801278815
LD-KAN200W-NB	200 W		26000 lm			ø390 x 179	3700 g	5902801279386

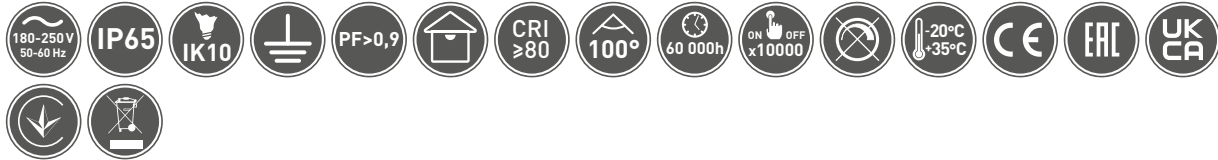

PL High-bay LED
EN High-bay LED fixture
RU Светодиодный светильник High Bay
UK Світлодіодний світильник High Bay

DALLAS

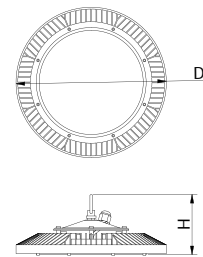

LD-DAL100W-NB	100 W	● 4000 K	10000 lm	aluminium, aluminium, алюминий, алюміній	ø260 x 104	czarny, black, черный, чорний	1600 g	5902801244988
LD-DAL150W-NB	150 W		15000 lm				ø300 x 120	2500 g

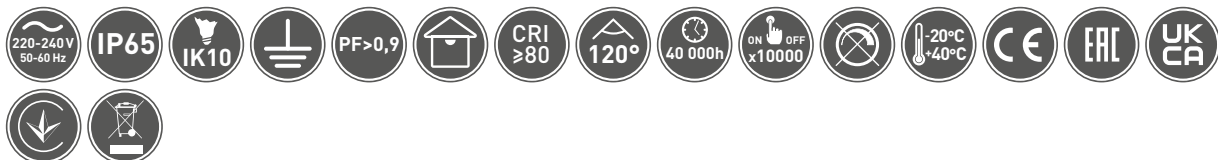





OPRAWY ULICZNE I PARKOWE LED
STREET AND PARK LED LUMINAIRES
СВЕТОДИОДНЫЕ УЛИЧНЫЕ И ПАРКОВЫЕ СВЕТИЛЬНИКИ
СВІТЛОДІОДНІ ВУЛИЧНІ ТА ПАРКОВІ СВЕТИЛЬНИКИ

PL Lampa uliczno-parkowa LED
EN Street and park LED lamp
RU Светодиодная лампа улично-парковая
UK Світлодіодна вулично-паркова лампа

PARKER III

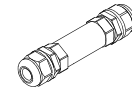

Aksesoria,
Accessories,
Аксессуары,
Аксесуари:

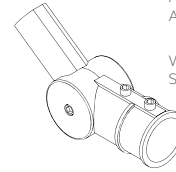

WZL-2
SA1, SA2

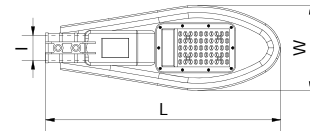

Model	Power (W)	Color Temp (K)	Light Output (lm)	Material	Dimensions (mm)	Power Factor (PF)	Weight (g)	Barcode
LD-PARK3L30W-40	30 W	4000 K	3000 lm	aluminium, aluminium, алюминий, алюміній	470 x 170 x 75 x ø50	PF > 0,9	1050 g	5902801382444
LD-PARK3L50W-40	50 W		5000 lm				5902801377181	
LD-PARK3L80W-40	80 W		8000 lm		580 x 210 x 80 x ø65		2400 g	5902801378379



PL Adapter do opraw uliczno-parkowych
EN Adapter for street fixtures
RU Адаптер для уличных ламп
UK Адаптер до вуличних ламп



SA1



SA2

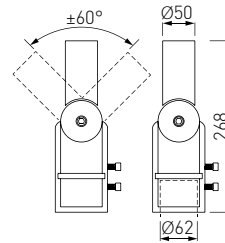

SA1

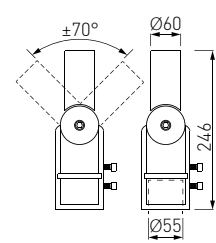

SA2



Model	Weight (g)	Barcode
SA1	680 g	5901867190840
SA2	550 g	5901867190864



PL Lampa uliczno-parkowa LED
EN Street and park LED lamp
RU Светодиодная лампа улично-парковая
UK Світлодіодна вулично-паркова лампа

INDIANA

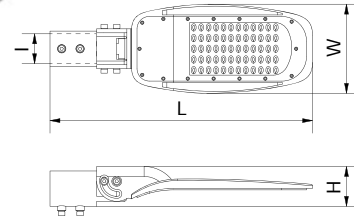

Technical & industrial
fixtures



Model	Power (W)	Color Temp (K)	Light Output (lm)	Material	Dimensions (mm)	Barcode
LD-IND60W-40	60 W	● 4000 K	7000 lm	aluminium, aluminium, алюминий, алюміній	525 × 180 × 80 × ø60	5902801318351
LD-IND100W-40	100 W		13000 lm		580 × 220 × 80 × ø60	5902801324185
LD-IND150W-40	150 W		19500 lm		635 × 250 × 80 × ø60	5902801318467



PL Lampa uliczno-parkowa LED
EN Street and park LED lamp
RU Светодиодная лампа улично-парковая
UK Світлодіодна вулично-паркова лампа

STELLA

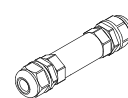

Aksesoria,
Accessories,
Аксессуары,
Аксесуари:
WZL-2

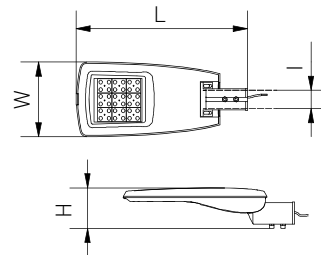

Model	Power (W)	Color Temp (K)	Light Output (lm)	PF	Material	Dimensions (mm)	Weight (g)	Barcode
LD-STEL080W-40	80 W	● 4000 K	10400 lm	PF > 0,9	aluminium, aluminium, алюминий, алюміній	610 × 256 × 145 × ø60	5000 g	5902801202179
LD-STEL150W-40	150 W		20300 lm			695 × 320 × 145 × ø60	7000 g	5902801202209







OPRAWY AWARYJNE LED
LED EMERGENCY LIGHT FIXTURES
АВАРИЙНЫЕ СВЕТИЛЬНИКИ
АВАРІЙНІ СВІТИЛЬНИКИ



PL Oprawa awaryjna LED
EN Emergency LED light fixture
RU Аварийный светодиодный светильник
UK Аварійний світлодіодний світильник

SAHER DUO

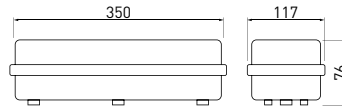

LD-SAHER1-DUO	3 W	1 h	6400 K	300 lm	PC	biały, white, белый, білий	805 g	5901867198280
LD-SAHER3-DUO		3 h					805 g	5901867198273



Technical & industrial fixtures

PL Oprawa awaryjna LED
EN Combined LED emergency fixture
RU Аварийный светодиодный светильник
UK Аварійний світлодіодний світильник

TERNO

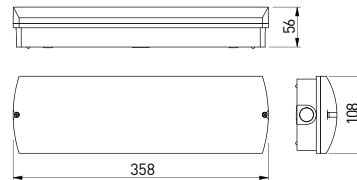

LD-TERNO1-00	3 W	1 h	6400 K	250 lm	PC	biały, white, белый, білий	600 g	5902801283338
LD-TERNO3-00		3 h					600 g	5902801284786



PL Oprawa awaryjna LED
EN Combined LED emergency fixture
RU Аварийный светодиодный светильник
UK Аварійний світлодіодний світильник

SALED

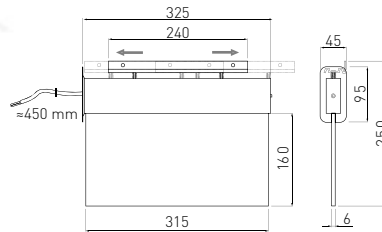

Technical & industrial fixtures



OA-SALED1-08	3 W	1 h	6400 K	aluminium, aluminium, алюминий, алюминій	chrom, chrome, хром, хром	910 g	5908231370440
OA-SALED3-08		3 h				910 g	5908231301956

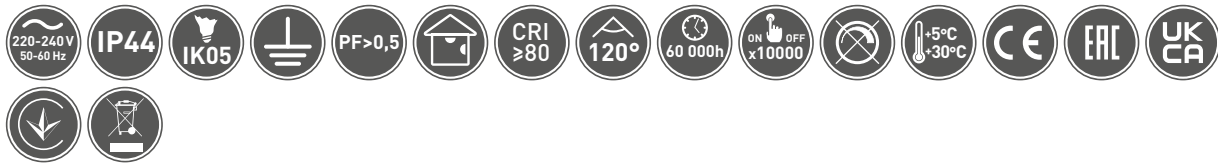

PL Oprawa awaryjna LED
EN Combined LED emergency fixture
RU Аварийный светодиодный светильник
UK Аварійний світлодіодний світильник

CORSO

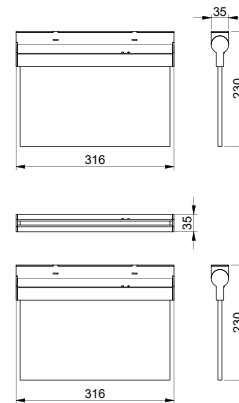

PL Oprawa awaryjna LED
EN Combined LED emergency fixture
RU Аварийный светодиодный светильник
UK Аварійний світлодіодний світильник

CORSO



LD-CORSO1-00	3 W	1 h	6400 K	PC	biały, white, белый, білий	960 g	5902801284649
LD-CORSO3-00		3 h				960 g	5902801284908

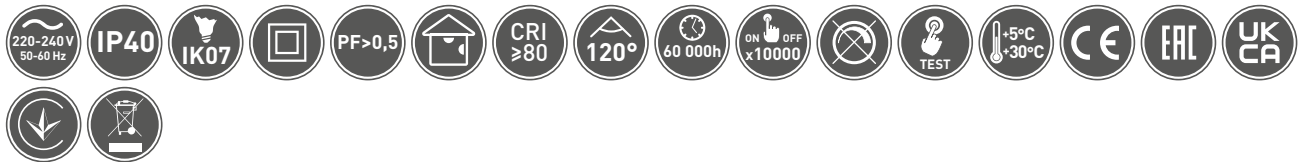

PL Oprawa awaryjna LED
EN Emergency fixture LED
RU Аварийный светильник LED
UK Аварійний світильник LED

OGLA



White

Black

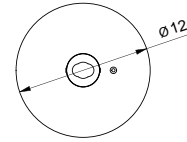

LD-OGLA3W-00	3 W	3 h	6400 K	200 lm	PC	biały, white, белый, білий	335 g	5902801284755
LD-OGLA3W-10						czarny, black, черный, чорний		5902801326110

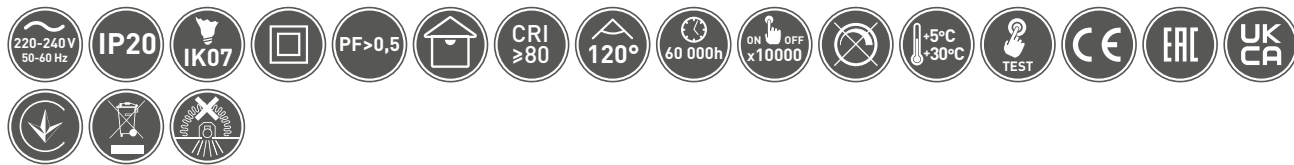

Technical & industrial fixtures

PL Oprawa awaryjna LED
EN Emergency fixture LED
RU Аварийный светильник LED
UK Аварійний світильник LED

ОМАНА-3

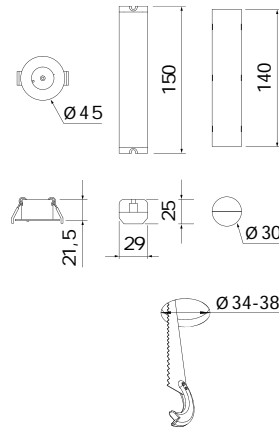

LD-OMAH33-00	3 W	3 h	6400 K	300 lm	PC + aluminium, PC + aluminium, PC + алюминий, PC + алюміній	biały, white, белый, білий	350 g	5902801240522

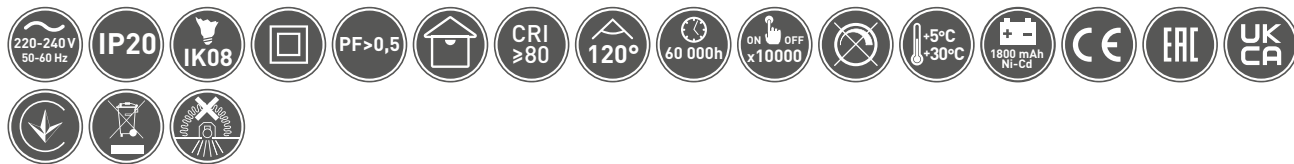



OPRAWY RASTROWE, KLOSZOWE
LOUVRE FIXTURES
РАСТРОВЫЕ СВЕТИЛЬНИКИ
РАСТРОВІ СВІТИЛЬНИКИ

PL Oprawa świetłówkowa T8
 EN Fixture for open LED light sources, T8
 RU Светильник для светодиодных ламп T8
 UK Світильник для світлодіодних ламп T8

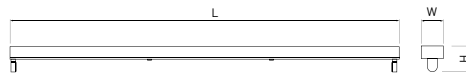

OS-OSL1120S-00	1230 × 42 × 47	blacha stalowa, steel sheet, стальной лист, сталевий лист		320 g	5901867173737
OS-OSL1150S-00	1530 × 42 × 47			420 g	5901867173751



Technical & industrial
fixtures



PL Oprawa świetłówkowa T8
 EN Fixture for open LED light sources, T8
 RU Светильник для светодиодных ламп T8
 UK Світильник для світлодіодних ламп T8

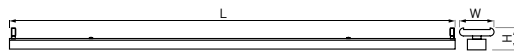

OS-OSL2120S-00	1230 × 100 × 47	blacha stalowa, steel sheet, стальной лист, сталевий лист		380 g	5901867173744
OS-OSL2150S-00	1530 × 100 × 47			470 g	5901867173768



PL Oprawa rastrowa natynkowa
 EN Surface mounted louvre fixture
 RU Растровый накладной светильник
 UK Растровий світильник поверхневого монтажу



Aksesoria,
 Accessories,
 Аксессуары,
 Аксесуари:



OS-HERZWKPL4-00

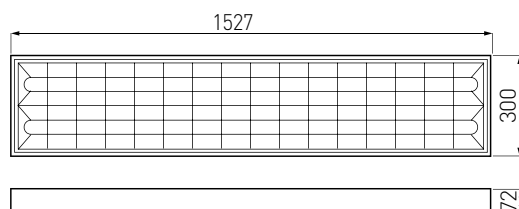

OS-LE150NJ-01



blacha stalowa, steel sheet,
 стальной лист, сталеий лист



biały, white,
 белый, білий



3750 g



5908231307637







OPRAWY PRZEMYSŁOWE
INDUSTRIAL FIXTURES
ПРОМЫШЛЕННЫЕ СВЕТИЛЬНИКИ
ПРОМИСЛОВІ СВІТИЛЬНИКИ

PL Oprawa LED do źródeł światła LED T8
 EN LED fitting for LED T8 light sources
 RU Светодиодный светильник для источников LED T8
 UK Світлодіодний світильник для джерел LED T8

ZEFIR

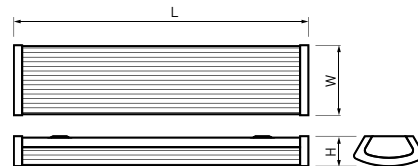

Technical & industrial
fixtures



Folder	LxWxH mm	Packaging	Material	Weight	Barcode
LD-OZE218-00	640 × 152 × 65	3	ABS + PC + blacha stalowa, ABS + PC + steel sheet, ABS + ПК + листовая сталь, ABS + PC + сталеви́й лист	700 g	5901867159632
LD-OZE236-00	1250 × 152 × 65	3	ABS + PC + blacha stalowa, ABS + PC + steel sheet, ABS + ПК + листовая сталь, ABS + PC + сталеви́й лист	1000 g	5901867151605



PL Oprawa LED do źródeł światła LED T8
 EN LED fitting for LED T8 light sources
 RU Светодиодный светильник для источников LED T8
 UK Світлодіодний світильник для джерел LED T8

ZEFIR

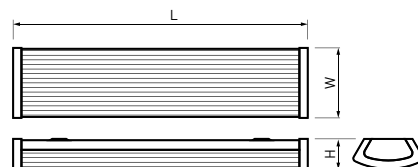

Folder	LxWxH mm	Packaging	Material	Weight	Barcode
LD-OZE218-01	640 × 152 × 65	3	ABS + PC + blacha stalowa, ABS + PC + steel sheet, ABS + ПК + листовая сталь, ABS + PC + сталеви́й лист	700 g	5901867177582
LD-OZE236-01	1250 × 152 × 65	3	ABS + PC + blacha stalowa, ABS + PC + steel sheet, ABS + ПК + листовая сталь, ABS + PC + сталеви́й лист	1000 g	5901867177698



PL Oprawa LED hermetyczna do źródeł światła LED T8
 EN Fixture for LED light sources, T8
 RU Герметический светильник для светодиодных ламп T8
 UK Герметичний світильник для світлодіодних ламп T8



Technical & industrial
fixtures

HAGEN

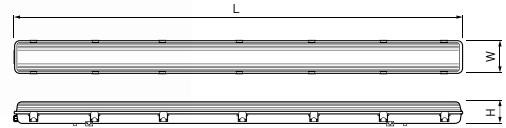

	LxWxH mm				
LD-HAG136-30	1288 x 72 x 68	PC / PC	biała, white, белый, білий	520 g	5901867194060
LD-HAG158-30	1598 x 72 x 68			900 g	5902801009877
LD-HAG218-30	684 x 114 x 68			1000 g	5901867194053
LD-HAG236-30	1288 x 114 x 68			900 g	5901867154606
LD-HAG258-30	1598 x 114 x 68			1000 g	5901867166395



PL Oprawa LED hermetyczna do źródeł światła LED T8
 EN Fixture for LED light sources, T8
 RU Герметический светильник для светодиодных ламп T8
 UK Герметичний світильник для світлодіодних ламп T8



HELIOS BIS

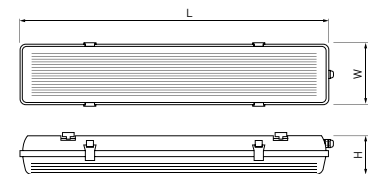

	LxWxH mm				
LD-HEL136B-30	1260 x 68 x 86	szary, grey, серый, сірий	ABS + PS	1500 g	5901867163325
LD-HEL218B-30	662 x 114 x 85			1500 g	5901867163301
LD-HEL236B-30	1260 x 114 x 86			1800 g	5901867163349
LD-HEL258B-30	1562 x 125 x 95			2500 g	5901867163363



- PL Zapinka metalowa do opraw HAGEN / HELIOS BIS, boczna
 EN Metal clamp for HAGEN / HELIOS BIS fixtures, side
 RU Металлическая защелка для светильников HAGEN / HELIOS BIS, боковая
 UK Зачіп металевий до світильників HAGEN / HELIOS BIS, боковий



	LD-HAG136-30	LD-HAG158-30	LD-HAG218-30	LD-HAG236-30	LD-HAG258-30	LD-HEL136B-30	LD-HEL218B-30	LD-HEL236B-30	LD-HEL258B-30
LD-HAG236KL-ME	12	14	8	12	14	-	-	-	-
LD-HEL236BU-ME	-	-	-	-	-	10	6	10	-
LD-HEL258BU-ME	-	-	-	-	-	-	-	-	12

		
LD-HAG236KL-ME	metal, metal, металл, метал	5901867189264
LD-HEL236BU-ME		5901867195548
LD-HEL258BU-ME		5902801026737

- PL Linka stalowa
 EN Steel cable
 RU Стальной трос
 UK Сталевий трос



				
OS-HERZW1-00	metal, metal, металл, метал	200 cm	19 g	5902801129551





PLAFONIERY I OPRAWY KANAŁOWE
CEILING AND BULKHEAD FIXTURES

ЖКХ СВЕТИЛЬНИКИ

ЖКГ СВИТИЛЬНИКИ

PL Plafoniera z czujnikiem ruchu
 EN Ceiling fixture with motion sensor
 RU Светильник с датчиком движения
 UK Стельовий світлодіодний світильник з датчиком руху

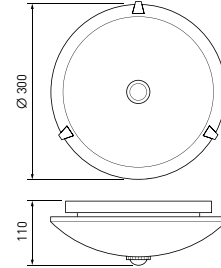

Technical & industrial fixtures



OS-PLCRKM-00	szkło + metal, glass + metal, стекло + металл, скло + метал	mleczny, soft white, белый матовый, молочний	1320 g	5908231302885
--------------	---	--	--------	---------------



PL Plafoniera z czujnikiem ruchu
 EN Ceiling fixture with motion sensor
 RU Светильник с датчиком движения
 UK Стельовий світильник з датчиком руху

VIZELA

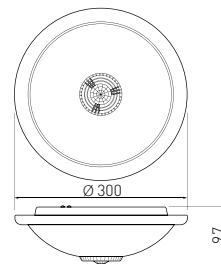

OS-PLCRKZ-00	szkło + metal, glass + metal, стекло + металл, скло + метал	biały, white, белый, білий	860 g	5908231339973
--------------	---	----------------------------	-------	---------------



- PL Plafoniera z mikrofalowym czujnikiem ruchu
- EN Ceiling fixture with microwave motion sensor
- RU Светильник с микроволновым датчиком движения
- UK Стельовий світильник з мікрохвильовим датчиком руху

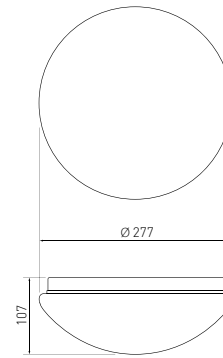

Technical & industrial
fixtures



OS-PLCZMI-00	tworzywo, plastic, пластмасса, пластик	mleczny, soft white, белый матовый, молочный	500 g	5908231336996
--------------	--	--	-------	---------------



- PL Plafoniera
- EN Ceiling fixture
- RU ЖКХ светильник
- UK ЖКГ світильник

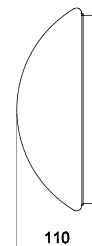
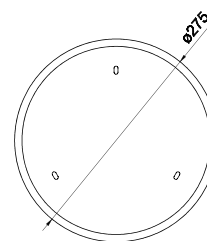

OS-PLCZOO-00	tworzywo, plastic, пластмасса, пластик	mleczny, soft white, белый матовый, молочный	300 g	5902801341601
--------------	--	--	-------	---------------



PL Oprawa kanałowa
EN Bulkhead fixture
RU ЖКХ Светильник
UK ЖКГ світильник

IBIZA

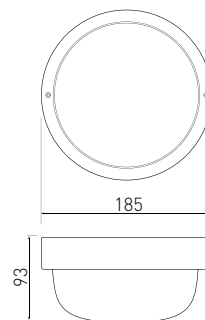

Technical & industrial fixtures

OS-IBBL060-00	korpus ABS; klosz szkło, body: ABS, lens: glass, корпус ABS, рассеиватель стекло, корпус: ABS; розсіювач: скло	biały, white, белый, білий	720 g	5908231338464



PL Oprawa kanałowa
EN Bulkhead fixture
RU ЖКХ Светильник
UK ЖКГ світильник

IBIZA

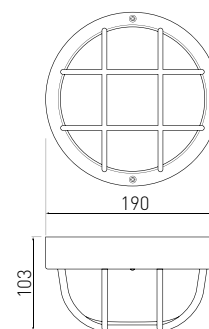

OS-IBKR060-00	korpus: ABS; klosz: szkło, body: ABS, lens: glass, корпус ABS, рассеиватель: стекло, корпус: ABS; розсіювач: скло	biały, white, белый, білий	710 g	5908231338457



PL Oprawa kanałowa
EN Bulkhead fixture
RU ЖКХ Светильник
UK ЖКГ світильник



RINGO

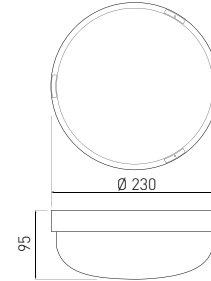

Technical & industrial
fixtures



OS-RINGO1-00	korpus: ABS; klosz: szkło hartowane body: ABS, lens: tempered glass, корпус ABS, рассеиватель: закаленное стекло, корпус: ABS; розсіювач: гартоване скло	biały, white, белый, білий	900 g	5901867122896
--------------	---	-------------------------------------	-------	---------------



PL Oprawa kanałowa z czujnikiem ruchu
EN Bulkhead fixture with motion sensor
RU ЖКХ Светильник с датчиком движения
UK ЖКГ світильник з датчиком руху



KACROO

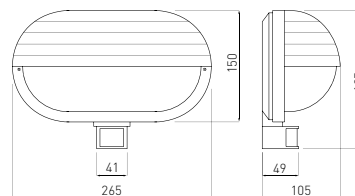

OS-KACROO-00	ABS + PC	biały, white, белый, білий	580 g	5908231302151
--------------	----------	----------------------------	-------	---------------





PL Oprawa kanałowa
EN Bulkhead fixture
RU ЖКХ Светильник
UK ЖКГ світильник

SANGUESA – KAY



White

Black

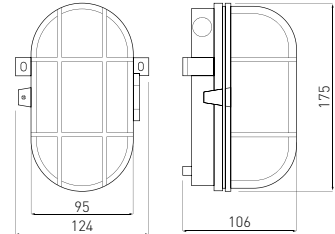

Technical & industrial
fixtures



OS-KAY060-00	korpus: ABS; klosz: szkło, body: ABS, lens: glass, корпус ABS, рассеиватель: стекло, корпус: ABS; розсіювач: скло	biały, white, белый, білий	560 g	5908231302137
OS-KAY060-10		czarny, black, черный, чорний		5908231302144



PL Oprawa kanałowa
EN Bulkhead fixture
RU ЖКХ Светильник
UK ЖКГ світильник

SANGUESA – KAM



White

Black

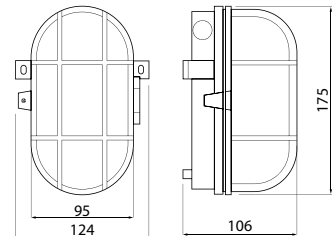

OS-KAM060-00	korpus: ABS; klosz: szkło, body: ABS, Lens: glass, корпус ABS, рассеиватель: стекло, корпус: ABS; розсіювач: скло	biały, white, белый, білий	500 g	5908231394620
OS-KAM060-10		czarny, black, черный, чорний		5908231337795







OPRAWY WARSZTATOWE I LATARKI LED
WORKSHOP FIXTURES AND LED FLASHLIGHTS
СВЕТИЛЬНИКИ ДЛЯ МАСТЕРСКОЙ И LED-ФОНАРИ
СВІТИЛЬНИКИ ДЛЯ МАЙСТЕРЕНЬ ТА СВІТЛОДІОДНІ ЛІХТАРИКИ

PL Oprawa przenośna
EN Portable fixture
RU Переносной светильник
UK Переносний світильник



OS-KAN527-24	60 W	tworzywo + metal, plastic + metal, пластик + металл, пластик + металл	550 g	5908231301307
--------------	------	--	-------	---------------



PL Oprawa przenośna
EN Portable fixture
RU Переносной светильник
UK Переносний світильник



OS-KAG508-10		tworzywo, plastic, пластмасса, пластик		5908231301284
--------------	--	--	--	---------------



PL Latarka LED
EN LED Flashlight
RU LED-фонарь
UK Світлодіодний ліхтарик

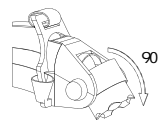
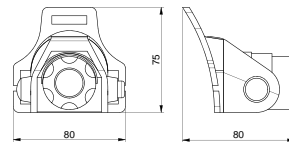

LT-LC6WT3-60	6 W	6400 K	350 lm	aluminium, aluminium, алюминий, алюміній	175 g	5902801216336
--------------	-----	--------	--------	--	-------	---------------



PL Latarka LED
EN LED Flashlight
RU LED-фонарь
UK Світлодіодний ліхтарик

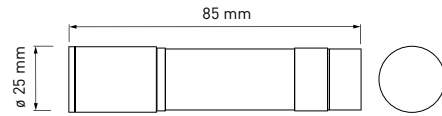

Technical & industrial
fixtures



LT-LK3WBL-60	3 W	6400 K	150 lm	aluminium, aluminium, алюминий, алюміній	35 g	5902801260063



PL Latarka LED
EN LED Flashlight
RU LED-фонарь
UK Світлодіодний ліхтарик

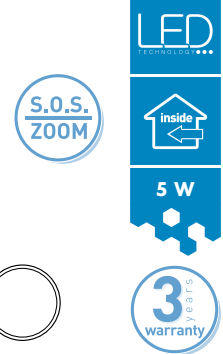
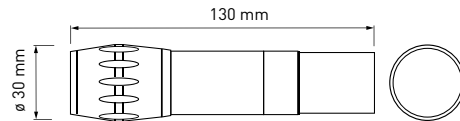

LT-LKSZ3W-60	5 W	6400 K	300 lm	aluminium, aluminium, алюминий, алюміній	130 g	5902801260124



PL Latarka LED
EN LED Flashlight
RU LED-фонарь
UK Світлодіодний ліхтарик

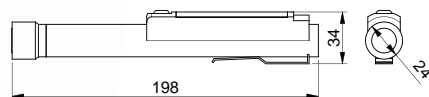

LT-LB6WT2-60	6 W	6400 K	400 lm	aluminium, aluminium, алюминий, алюміній	140 g	5902801215858



PL Latarka LED
EN LED Flashlight
RU LED-фонарь
UK Світлодіодний ліхтарик

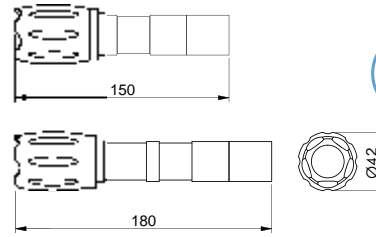

LT-LB8WT6-60	8 W	6400 K	800 lm	aluminium, aluminium, алюминий, алюміній	135 g	5902801215278
--------------	-----	--------	--------	---	-------	---------------



PL Latarka LED
EN LED Flashlight
RU LED-фонарь
UK Світлодіодний ліхтарик

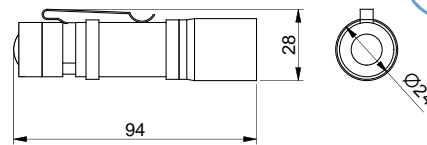

LT-LB3WT4-60	3 W	6400 K	200 lm	aluminium, aluminium, алюминий, алюміній	40 g	5902801215797
--------------	-----	--------	--------	---	------	---------------



PL Latarka LED
EN LED Flashlight
RU LED-фонарь
UK Світлодіодний ліхтарик

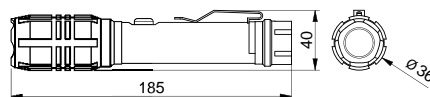

LT-LA8WT2-60	8 W	6400 K	800 lm	aluminium, aluminium, алюминий, алюміній	220 g	5902801215865
--------------	-----	--------	--------	---	-------	---------------







OPRAWY DEKORACYJNE
DECORATIVE FIXTURES
ДЕКОРАТИВНЫЕ СВЕТИЛЬНИКИ
ДЕКОРАТИВНІ СВІТИЛЬНИКИ



Oprawy sufitowe Ceiling fixtures Потолочные светильники Стельові світильники.....	169
Oprawy punktowe Spot light fixtures Точечные светильники Точкові світильники	220
Oprawy ogrodowe i elewacyjne Garden and wall fixtures Садовые и фасадные светильники Садові та фасадні світильники	248
Lampki Desk lamps Настольные лампы Лампи настільні	294



OPRAWY SUFITOWE
CEILING FIXTURES
ПОТОЛОЧНЫЕ СВЕТИЛЬНИКИ
СТЕЛЬОВІ СВІТИЛЬНИКИ

PL Oprawa liniowa LED
EN Linear LED fixture
RU Линейный светильник LED
UK Лінійний світильник LED

OMEGA

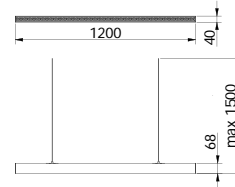
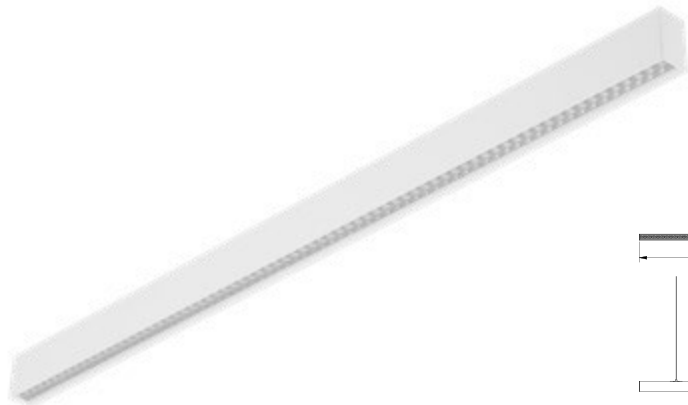

LD-OME50WNB-10-A*	50 W	max 15	● 4000 K	4500 lm	biały, white, белый, білий	aluminium + PC, aluminum + PC, алюминий + PC, алюміній + PC,	1420 g	5902801245923
LD-OME50WNB-10-C								5902801245992

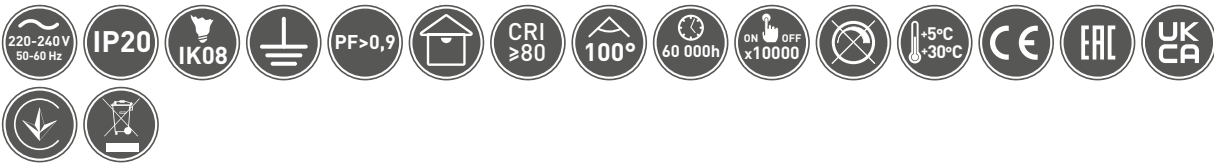

PL Akcesoria
EN Accessories
RU Аксессуары
UK Аксесуари

OMEGA



LD-OME30WNB-10-L

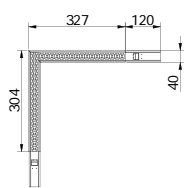

LD-OME30WNB-10-T

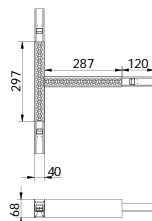

LK-OMEGA-OP

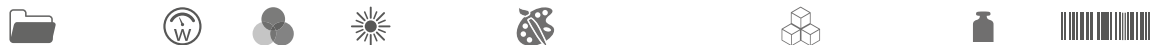
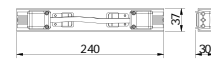

LD-OME30WNB-10-L	30 W	● 4000 K	2700 lm	biały, white, белый, білий	aluminium + PC, aluminum + PC, алюминий + PC, алюміній + PC,	940 g	5902801245985
LD-OME30WNB-10-T						1060 g	5902801245831
LK-OMEGA-OP	-	-	-	-	metal, metal, металл, металл	100 g	5902801246012





PL Oprawa zwieszana LED
EN LED suspended luminaire
RU Подвесной светильник LED
UK Підвісний світильник LED

LED
LED LIGHTING

inside

40 W

5 years warranty

LUNA

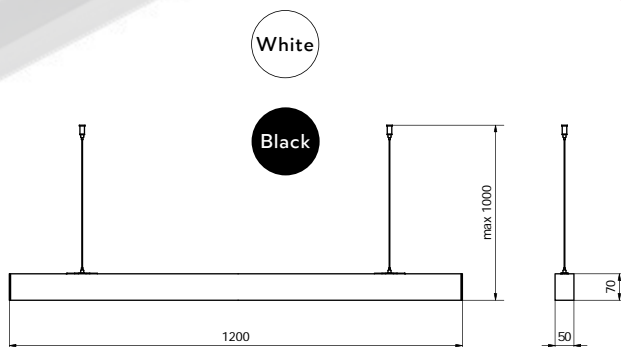
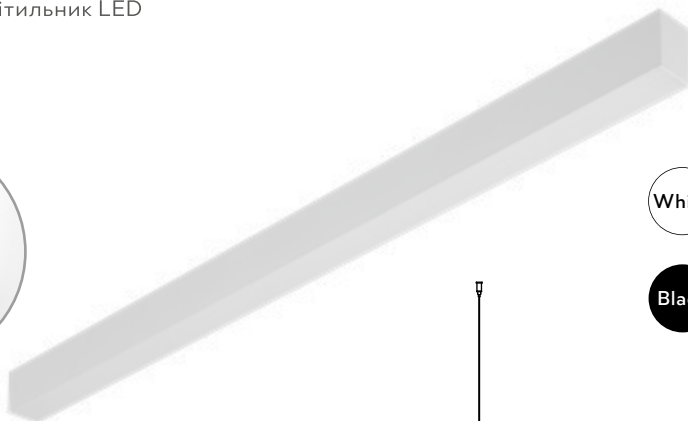
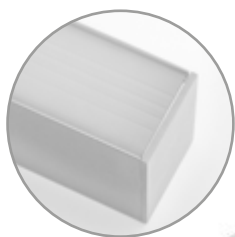

LD-LUN40WNB-10-A	40 W	4000 K	3200 lm	biały, white, белый, білий	aluminium + PC, aluminum + PC, алюміній + PC,	1450 g	5902801245916
LD-LUN40WNB-00-A				czarny, black, черный, чорний			5902801245961



PL Rama do montażu wpuszczanego
EN Frame for recessed mounting
RU Рама для встраиваемого монтажа
UK Рама для вбудованого монтажу

LUNA

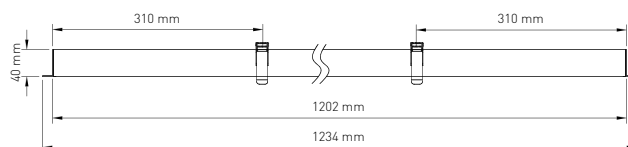
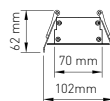

White

Black

LED
LED LIGHTING

inside

5 years warranty



RM-LUNA120-10	-	-	-	biały, white, белый, білий	aluminium, aluminium, алюміній, алюміній	850 g	5902801332258
RM-LUNA120-00	-	-	-	czarny, black, черный, чорний			5902801332487

PL Oprawa zwieszana LED
EN LED suspended luminaire
RU Подвесной светильник LED
UK Підвісний світильник LED

LIVIA

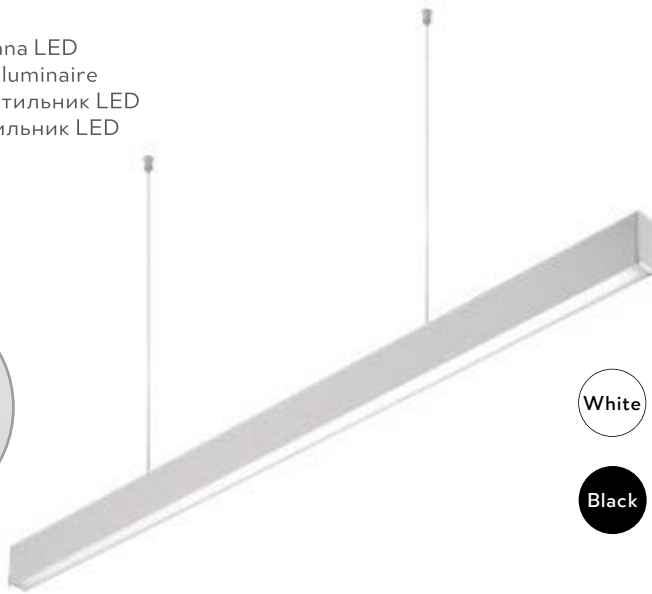
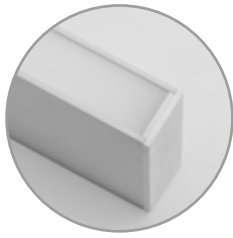

White

Black

Aksesoria,
Accessories,
Аксессуары,
Аксесуари:

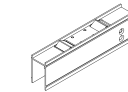

LK-LIVIA-OP

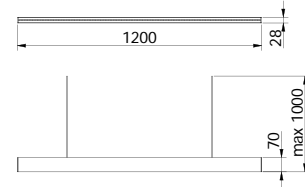

LED



40 W

5 years warranty



LD-LIV40WNB-10	40 W	● 4000 K	3600 lm	biały, white, белый, білий	aluminium, aluminium, алюминий, алюміній	1300 g	5902801245893
LD-LIV40WNB-00				czarny, black, черный, чорний			5902801243899
LK-LIVIA-OP	-	-	-	aluminium, aluminium, алюминий, алюміній		70 g	5902801377143

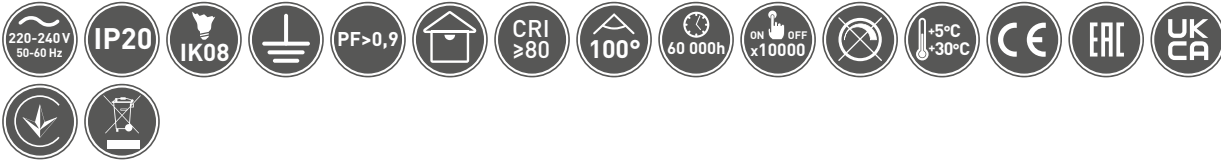

PL Oprawa zwieszana LED
EN LED suspended luminaire
RU Подвесной светильник LED
UK Підвісний світильник LED

VILANA

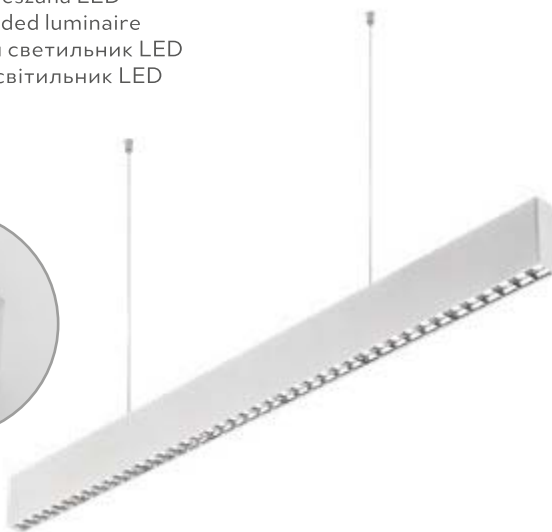

White

Black

Aksesoria,
Accessories,
Аксессуары,
Аксесуари:

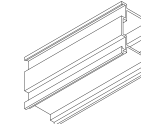

LK-VILANA-00

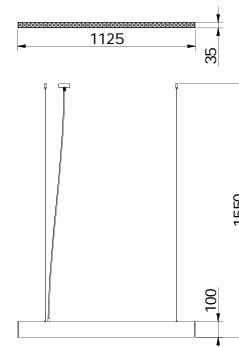

LED



42 W

UGR<19

12W / 30W

5 years warranty



LD-VIL42WUDB-NB	42 W	● 4000 K	3780 lm	biały, white, белый, білий	aluminium, aluminium, алюминий, алюміній	2100 g	5902801237515
LD-VIL42WUDC-NB				czarny, black, черный, чорний			5902801237546
LK-VILANA-00	-	-	-	aluminium, aluminium, алюминий, алюміній		170 g	5902801285820



PL Oprawa zwieszana LED
EN LED suspended luminaire
RU Подвесной светильник LED
UK Підвісний світильник LED

FORTA

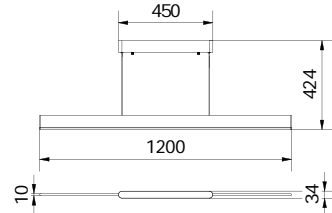

LED
TECHNOLOGY

inside

36 W

5 years
warranty



LD-FRT36WB-NB	36 W	4000 K	2900 lm	biały, white, белый, білий	aluminium, aluminium, алюминий, алюміній	3300 g	5902801293313



PL Oprawa LED
EN LED fixture
RU Светодиодный светильник
UK Світлодіодний світильник

JASMIN

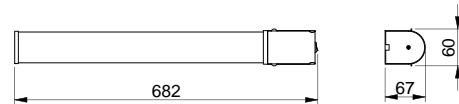
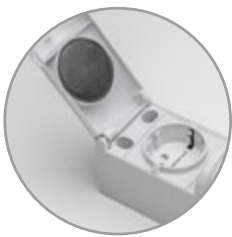

LED
TECHNOLOGY

inside

15 W

5 years
warranty

LD-JAS15W-40	15 W	4000 K	1200 lm	PC	biały, white, белый, білий	PF > 0,5	760 g	5902801200540

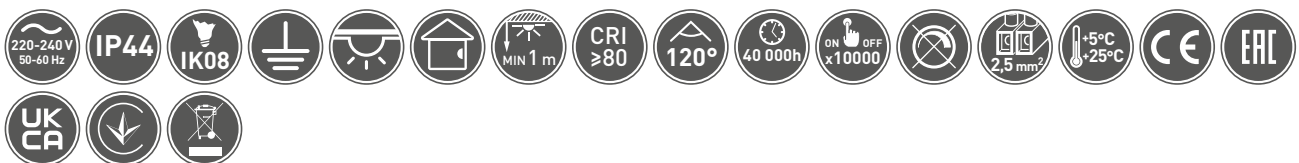

PL Oprawa LED
EN LED fixture
RU Светодиодный светильник
UK Світлодіодний світильник

ZITA



White

Chrome

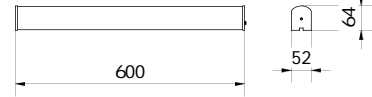

LD-ZIT600W-01	15 W	4000 K	1200 lm	aluminium + PC, aluminium + PC, алюминий + PC, алюминий + PC,	chrom, chrome, хром, хром	4600 g	5902801399329
LD-ZIT600W-00					biały, white, белый, білий		5902801399466



PL Oprawa LED
EN LED fixture
RU Светодиодный светильник
UK Світлодіодний світильник

PRIME

360°



White

Black

Grey

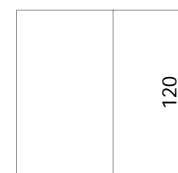
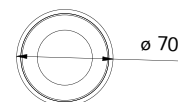

LD-PRM10WB-NB	10 W	4000 K	1000 lm	biały, white, белый, білий	aluminium, aluminium, алюминий, алюминий	260 g	5902801293344
LD-PRM10WC-NB				czarny, black, черный, чорний			5902801293238
LD-PRM10WS-NB				szary, grey, серый, сірий			5902801293481



Decorative fixtures

PL Oprawa LED
EN LED fixture
RU Светодиодный светильник
UK Світлодіодний світильник

LED
LED LIGHTING

inside

8 W

3 years
warranty

BIANCO

360°



White

Black

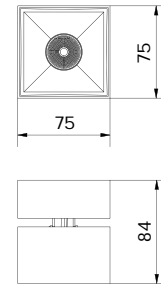

LD-BNC8WKB-NB	8 W	4000 K	680 lm	biały, white, белый, білий	aluminium, aluminium, алюминий, алюміній	320 g	5902801293412
LD-BNC8WKC-NB				czarny, black, черный, чорний			5902801293368



Decorative fixtures



PL Oprawa LED
EN LED fixture
RU Светодиодный светильник
UK Світлодіодний світильник

LED
LED LIGHTING

inside

8 W

3 years
warranty

BIANCO

360°



White

Black

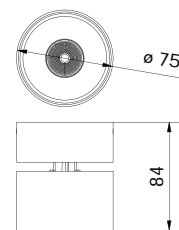

LD-BNC8WOB-NB	8 W	4000 K	680 lm	biały, white, белый, білий	aluminium, aluminium, алюминий, алюміній	320 g	5902801293351
LD-BNC8WOC-NB				czarny, black, черный, чорний			5902801293450

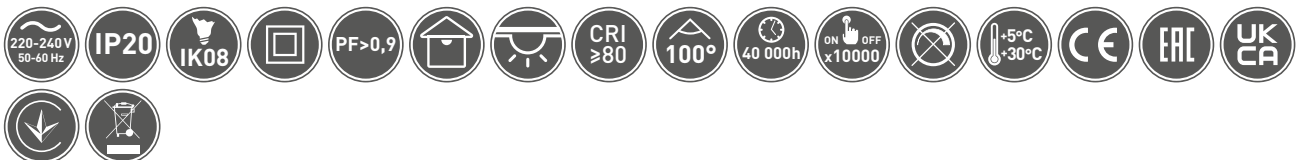



PL Oprawa LED
EN LED fixture
RU Светодиодный светильник
UK Світлодіодний світильник

BIANCO CCT



White

Black

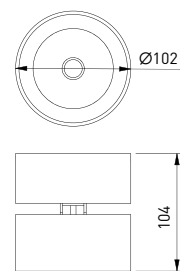

LD-BNCC8WOB-NB	8 W	<ul style="list-style-type: none"> ● 2700 K ● 3300 K ● 4000 K 	680 lm	biały, white, белый, білий	aluminium, aluminium, алюминий, алюміній	320 g	5902801457043
LD-BNCC8WOC-NB				czarny, black, черный, чорний			5902801457012



PL Oprawa LED
EN LED fixture
RU Светодиодный светильник
UK Світлодіодний світильник

BIANCO CCT



White

Black

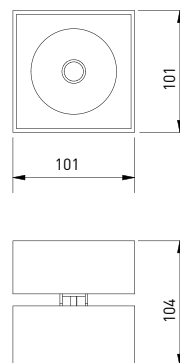

LD-BNCC8WKB-NB	8 W	<ul style="list-style-type: none"> ● 2700 K ● 3300 K ● 4000 K 	680 lm	biały, white, белый, білий	aluminium, aluminium, алюминий, алюміній	320 g	5902801457036
LD-BNCC8WKC-NB				czarny, black, черный, чорний			5902801457104



BIANCO CCT

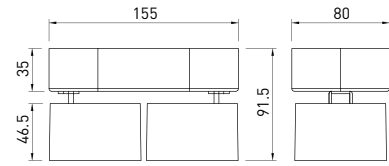

LD-BNCC16WOB2-NB	2 x 8 W	<ul style="list-style-type: none"> 2700 K 3300 K 4000 K 	1360 lm	biały, white, белый, білий	aluminium, aluminium, алюминий, алюміній	700 g	5902801457142
LD-BNCC16WOC2-NB				czarny, black, черный, чорний			5902801457029



Decorative fixtures



PL Oprawa LED
EN LED fixture
RU Светодиодный светильник
UK Світлодіодний світильник

LED
LIGHTING

inside

15 W

3 years
warranty

BIANCO



White

Black

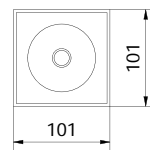

LD-BNC15WKB-NB	15 W	● 4000 K	1500 lm	biały, white, белый, білий	aluminium, aluminium, алюминий, алюміній	680 g	5902801367090
LD-BNC15WKC-NB				czarny, black, черный, чорний			5902801367144



PL Oprawa LED
EN LED fixture
RU Светодиодный светильник
UK Світлодіодний світильник

BIANCO



White

Black

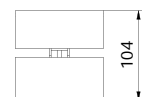
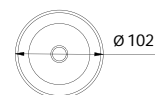

LD-BNC15WOB-NB	15 W	● 4000 K	1500 lm	biały, white, белый, білий	aluminium, aluminium, алюминий, алюміній	600 g	5902801367182
LD-BNC15WOC-NB				czarny, black, черный, чорний			5902801367151





PL Oprawa LED
EN LED fixture
RU Светодиодный светильник
UK Світлодіодний світильник

LED
LED LIGHTING

inside

8 W

3 years warranty

SIERRA



White

Black

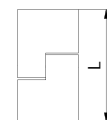
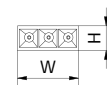

LD-SRA08WB-NB	8 W	● 4000 K	720 lm	biały, white, белый, білий	aluminium, aluminium, алюминий, алюміній	155 x 84 x 34	410 g	5902801357268
LD-SRA08WC-NB				czarny, black, черный, чорний				5902801357459



Decorative fixtures



PL Oprawa LED
EN LED fixture
RU Светодиодный светильник
UK Світлодіодний світильник

SIERRA

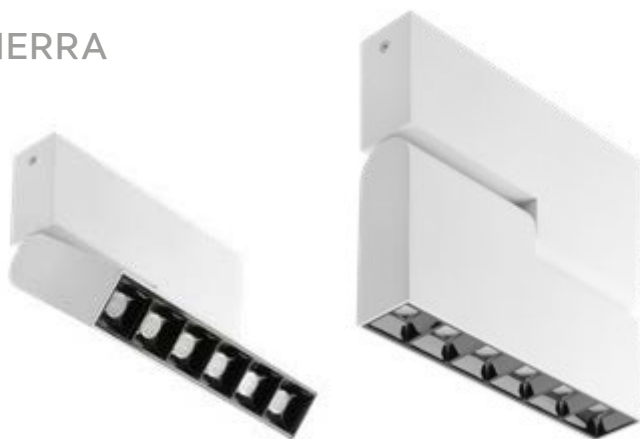

White

Black

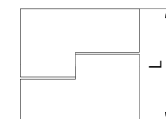
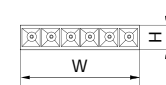

LD-SRA18WB-NB	18 W	● 4000 K	1620 lm	biały, white, белый, білий	aluminium, aluminium, алюминий, алюміній	158 x 163 x 34	770 g	5902801357466
LD-SRA18WC-NB				czarny, black, черный, чорний				5902801357497



LED
LED LIGHTING

inside

18 W

3 years warranty



PL Oprawa LED
EN LED fixture
RU Светодиодный светильник
UK Світлодіодний світильник

LED
LED LIGHTING

inside

15 W

3 years
warranty

ARTEMIDA

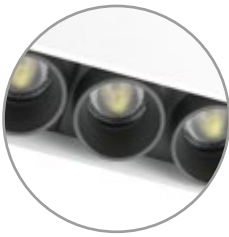

White

Black

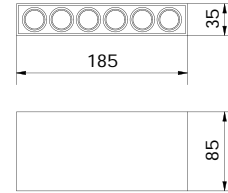

LD-ATM15WBP-NB	15 W	● 4000 K	1420 lm	biały, white, белый, білий	aluminium, aluminium, алюминий, алюміній	270 g	5902801322365
LD-ATM15WCP-NB				czarny, black, черный, чорний			5902801322341

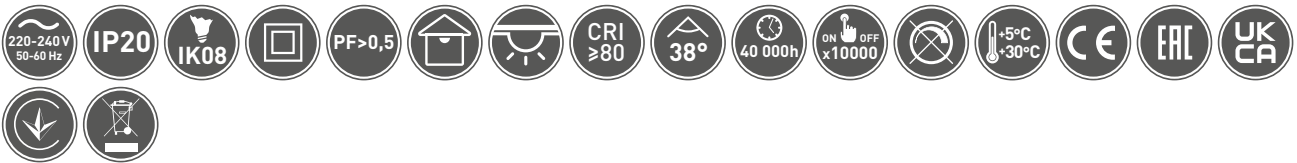

PL Oprawa LED
EN LED fixture
RU Светодиодный светильник
UK Світлодіодний світильник

ARTEMIDA

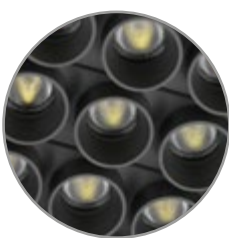

White

Black

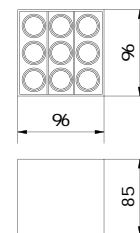

LD-ATM20WBK-NB	20 W	● 4000 K	1920 lm	biały, white, белый, білий	aluminium, aluminium, алюминий, алюміній	520 g	5902801322334
LD-ATM20WCK-NB				czarny, black, черный, чорний			5902801322457

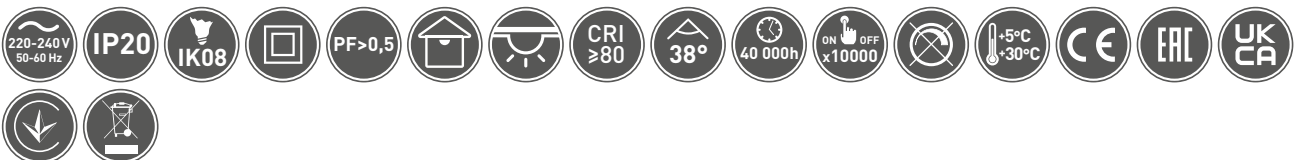

LED
LED LIGHTING

inside

20 W

3 years
warranty



PL Oprawa sufitowa
EN Ceiling fixture
RU Потолочный светильник
UK Стельовий світильник



TENSA

360°



White

Black

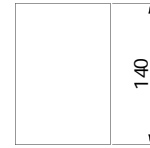
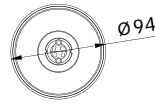

OS-TENGU10-10	max 20 W	biały, white, белый, білий	aluminium, aluminium, алюминий, алюміній	425 g	5902801274633
OS-TENGU10-00		czarny, black, черный, чорний			5902801274596



PL Oprawa sufitowa
EN Ceiling fixture
RU Потолочный светильник
UK Стельовий світильник



TENSA

360°



White

Black

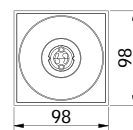

OS-TENGU10KW-10	max 20 W	biały, white, белый, білий	aluminium, aluminium, алюминий, алюміній	475 g	5902801274664
OS-TENGU10KW-00		czarny, black, черный, чорний			5902801274763





PL Oprawa sufitowa
EN Ceiling fixture
RU Потолочный светильник
UK Стельовий світильник

AERO II

360°



White

Black

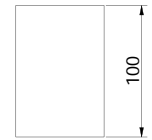
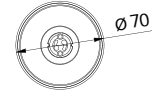

Decorative fixtures



OS-AERD20W-10	max 20 W	biały, white, белый, білий	aluminium, aluminium, алюминий, алюміній	210 g	5902801396250
OS-AERD20W-00		czarny, black, черный, чорний			5902801396939



PL Oprawa sufitowa LED
EN LED suspended luminaire
RU Подвесной светильник LED
UK Підвісний світильник LED

LAGOS II



White

Black

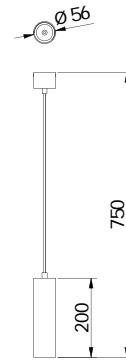

OS-LAGD20W-10	max 20 W	biały, white, белый, білий	aluminium, aluminium, алюминий, алюміній	400 g	5902801396892
OS-LAGD20W-00		czarny, black, черный, чорний			5902801396960



PL Oprawa sufitowa LED
EN LED suspended luminaire
RU Подвесной светильник LED
UK Підвісний світильник LED

TRESOS II



White

Black

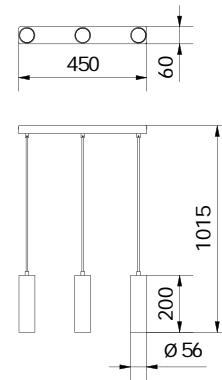

OS-TRESD320W-10	max 3x20 W	czarny, black, черный, чорний	aluminium, aluminium, алюминий, алюміній	1400 g	5902801397004
OS-TRESD320W-00		biały, white, белый, білий			5902801396946



PL Oprawa sufitowa
EN Ceiling fixture
RU Потолочный светильник
UK Стельовий світильник

AVEIRO BIS

360°



White

Black

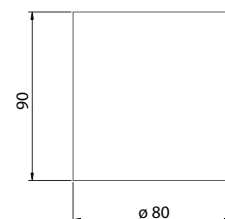
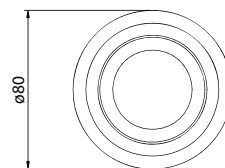

OS-AVB8090OK1-10	max 20 W	biały, white, белый, білий	aluminium, aluminium, алюминий, алюміній	216 g	5902801396731
OS-AVB8090OK1-00		czarny, black, черный, чорний			5902801396779



PL Oprawa sufitowa
EN Ceiling fixture
RU Потолочный светильник
UK Стельовий світильник

AVEIRO BIS

360°



White

Black

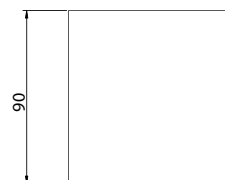
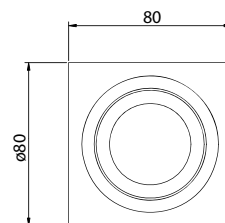

OS-AVB8090KW1-10	max 20 W	biały, white, белый, білий	aluminium, aluminium, алюминий, алюміній	320 g	5902801396748
OS-AVB8090KW1-00		czarny, black, черный, чорний			5902801396823





PL Oprawa sufitowa
EN Ceiling fixture
RU Потолочный светильник
UK Стельовий світильник

AVEIRO DUO BIS

360°



White

Black

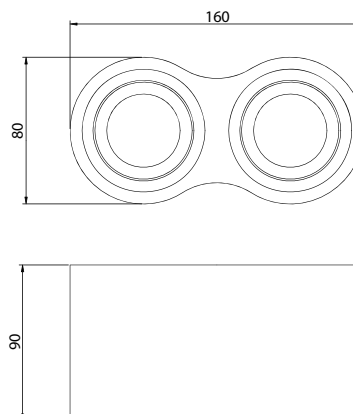

OS-AVB80160OK2-10	max 2 x 20 W	biały, white, белый, білий	aluminium, aluminium, алюминий, алюміній	510 g	5902801396717
OS-AVB80160OK2-00		czarny, black, черный, чорний			5902801396816



PL Oprawa sufitowa
EN Ceiling fixture
RU Потолочный светильник
UK Стельовий світильник

AVEIRO DUO BIS

360°



White

Black

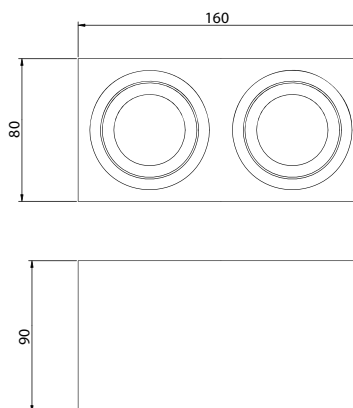

OS-AVB80160KW2-10	max 2 x 20 W	biały, white, белый, білий	aluminium, aluminium, алюминий, алюміній	525 g	5902801396885
OS-AVB80160KW2-00		czarny, black, черный, чорний			5902801396908





PL Oprawa sufitowa
EN Ceiling light fixture
RU Потолочный светильник
UK Стельовий світильник

SENSA MINI



Black

White

Aksesoria,
Accessories,
Аксесуари,
Аксесуари:

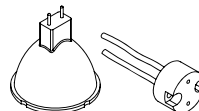

MR16 GZ-MR16-0000

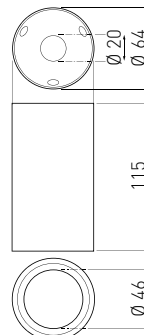

OS-SENM5081OKCZ-00	max 50 W	czarny, black, черный, чорний	aluminium, aluminium, алюминий, алюміній	5901867176769
OS-SENM5081OKB-10		biały, white, белый, білий		5901867176752



PL Oprawa sufitowa
EN Ceiling light fixture
RU Потолочный светильник
UK Стельовий світильник

SENSA MINI



White

Black

Aksesoria,
Accessories,
Аксесуари,
Аксесуари:

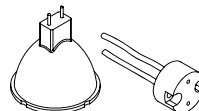

MR16 GZ-MR16-0000

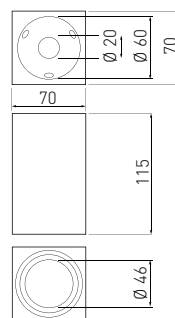

OS-SENM5091KWB-10	max 50 W	biały, white, белый, білий	aluminium, aluminium, алюминий, алюміній	5901867176837
OS-SENM5091KW CZ-00		czarny, black, черный, чорний		5901867176851





PL Oprawa sufitowa
EN Ceiling light fixture
RU Потолочный светильник
UK Стельовий світильник



SENSA



Black

White

Aksesoria,
Accessories,
Аксессуары,
Аксесуари:

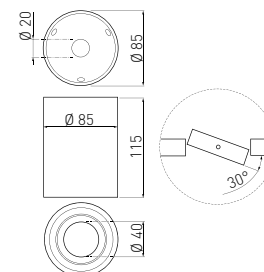
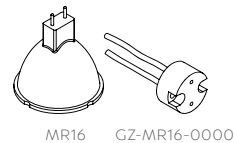

OS-SEN5087OKCZ-00	max 50 W	czarny, black, черный, чорний	aluminium, aluminium, алюминий, алюміній	5901867176813
OS-SEN5087OKB-10		biały, white, белый, білий		5901867176776



Decorative fixtures

PL Oprawa sufitowa
EN Ceiling light fixture
RU Потолочный светильник
UK Стельовий світильник



SENSA

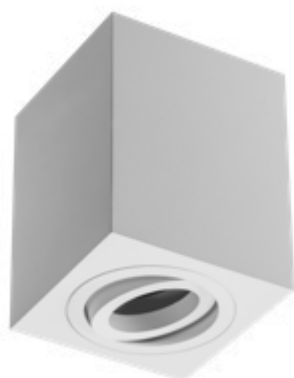

White

Black

Aksesoria,
Accessories,
Аксессуары,
Аксесуари:

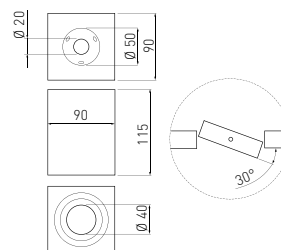
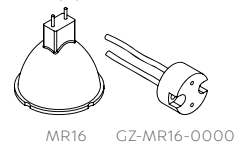

OS-SEN5097KWB-10	max 50 W	biały, white, белый, білий	aluminium, aluminium, алюминий, алюміній	5901867176875
OS-SEN5097KW CZ-00		czarny, black, черный, чорний		5901867176899



PL Oprawa sufitowa
EN Ceiling light fixture
RU Потолочный светильник
UK Стельовий світильник

SENSA AQUA



White

Grey

Black

Aksesoria,
Accessories,
Аксессуары,
Аксесуари:

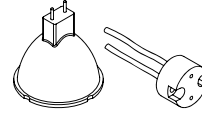

MR16 GZ-MR16-0000

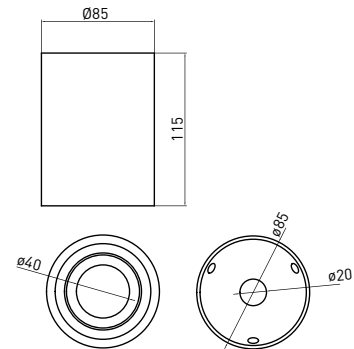

3 years warranty

OS-SENAQ5087OKB-10	max 50 W	biały, white, белый, білий	aluminium, aluminium, алюминий, алюміній	300 g	5902801233791
OS-SENAQ5087OKB-80		szary, grey, серый, сірий			5902801233821
OS-SENAQ5087OKCZ-00		czarny, black, черный, чорний			5902801233838

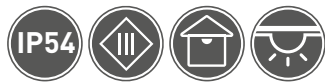

PL Oprawa sufitowa
EN Ceiling light fixture
RU Потолочный светильник
UK Стельовий світильник

SENSO DUO



White

Black

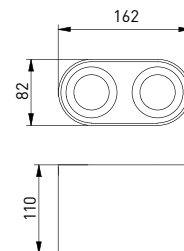

GU10

3 years warranty

OS-SEND5083OKB-10	max 2 x 50 W	biały, white, белый, білий	aluminium, aluminium, алюминий, алюміній	720 g	5902801129971
OS-SEND5083OKCZ-00		czarny, black, черный, чорний			5902801129933



Decorative fixtures

PL Oprawa sufitowa
EN Ceiling light fixture
RU Потолочный светильник
UK Стельовий світильник

Aksesoria,
Accessories,
Аксессуары,
Аксесуари:

RESTO



White

Black

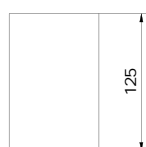
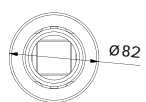
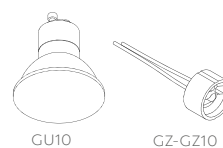

OS-RST80125OK1-10	max 10 W LED only	biały, white, белый, білий	PC	110 g	5902801319556
OS-RST80125OK1-00		czarny, black, черный, чорний			5902801319457



PL Oprawa sufitowa
EN Ceiling light fixture
RU Потолочный светильник
UK Стельовий світильник

Aksesoria,
Accessories,
Аксессуары,
Аксесуари:

RESTO



White

Black

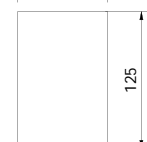
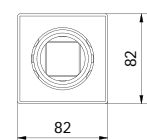
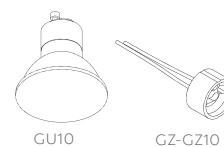

OS-RST8080KW1-10	max 10 W LED only	biały, white, белый, білий	PC	130 g	5902801319570
OS-RST8080KW1-00		czarny, black, черный, чорний			5902801319433





PL Oprawa sufitowa
EN Ceiling light fixture
RU Потолочный светильник
UK Стельовий світильник

Aksesoria,
Accessories,
Аксессуары,
Аксесуари:

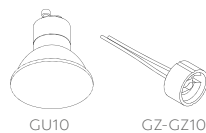

ARIES



OS-ARIOK-11



OS-ARIOK-13



OS-ARIOK-22



OS-ARIOK-23

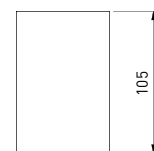
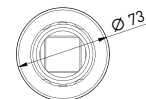

OS-ARIOK-11	max 20 W	czarny, black, черный, чорний	PC	80 g	5902801440113
OS-ARIOK-22		czarny chrom, black chrome, черный хром, чорний хром			5902801442841
OS-ARIOK-23		chrom, chrome, хром, хром			5902801442889
OS-ARIOK-13		zloto, gold, золото, золото			5902801442803



PL Oprawa sufitowa
EN Ceiling light fixture
RU Потолочный светильник
UK Стельовий світильник

Aksesoria,
Accessories,
Аксессуары,
Аксесуари:

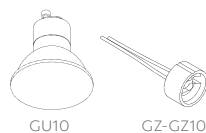

ARIES



OS-ARIKW-11



OS-ARIKW-13



OS-ARIKW-22



OS-ARIKW-23

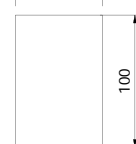
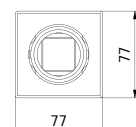

OS-ARIKW-11	max 20 W	czarny, black, черный, чорний	PC	90 g	5902801443114
OS-ARIKW-22		czarny chrom, black chrome, черный хром, чорний хром			5902801442933
OS-ARIKW-23		chrom, chrome, хром, хром			5902801402470
OS-ARIKW-13		zloto, gold, золото, золото			5902801402630



DRAGO

360°



White

Black

Grey

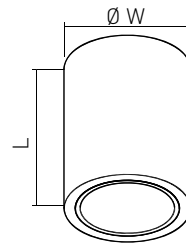

LxW
mm



OS-DRAGO14-10	max 60 W	biały, white, белый, білий	metal, metal, металл, метал	148 x ø133	390 g	5902801230394
OS-DRAGO18-10				180 x ø172	700 g	5902801230400
OS-DRAGO14-00		czarny, black, черный, чорний		148 x ø133	390 g	5902801231131
OS-DRAGO18-00				180 x ø172	700 g	5902801231063
OS-DRAGO14-80		szary, grey, серый, сірий		148 x ø133	390 g	5902801364341
OS-DRAGO18-80				180 x ø172	700 g	5902801364983



PL Oprawa sufitowa
EN Ceiling light fixture
RU Потолочный светильник
UK Стельовий світильник

BLINK II



White

Black



OS-BLND50W1-10	max. 20 W	biały, white, белый, білий	aluminium, aluminium, алюминий, алюміній	267 g	5902801438813
OS-BLND50W1-00		czarny, black, черный, чорний			5902801439735



PL Oprawa sufitowa
EN Ceiling light fixture
RU Потолочный светильник
UK Стельовий світильник

BLINK II



White

Black



OS-BLND50W2-10	max. 2 x 20 W	biały, white, белый, білий	aluminium, aluminium, алюминий, алюміній	560 g	5902801438301
OS-BLND50W2-00		czarny, black, черный, чорний			5902801440069



PL Oprawa sufitowa
EN Ceiling light fixture
RU Потолочный светильник
UK Стельовий світильник

BLINK II

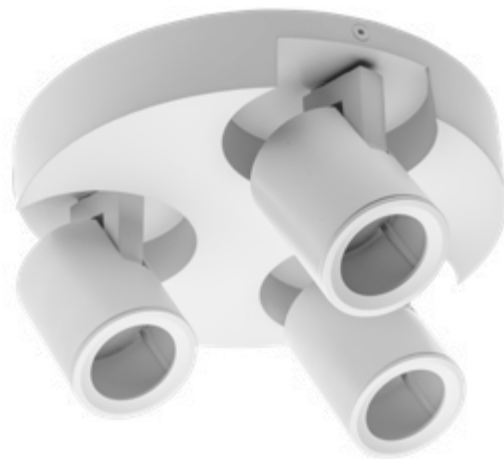

White

Black



OS-BLND50W3-10	max. 3 x 20 W	biały, white, белый, білий	aluminium, aluminium, алюминий, алюміній	850 g	5902801438271
OS-BLND50W3-00		czarny, black, черный, чорний			5902801440120



Decorative fixtures



PL Oprawa sufitowa
EN Ceiling light fixture
RU Потолочный светильник
UK Стельовий світильник

FARGO II



White

Black

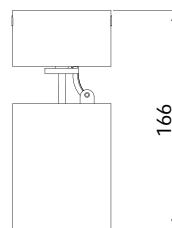
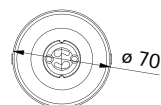

OS-FRG20W2-10	max 20 W	biały, white, белый, білий	aluminium, aluminium, алюминий, алюміній	280 g	5902801391255
OS-FRG20W2-00		czarny, black, черный, чорний			5902801391286



PL Oprawa sufitowa
EN Ceiling light fixture
RU Потолочный светильник
UK Стельовий світильник

FARGO MINI II



White

Black

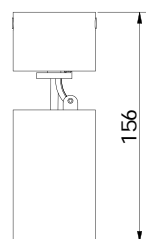
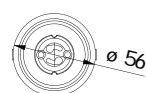

OS-FRG20W2-10-MINI	max 20 W	biały, white, белый, білий	aluminium, aluminium, алюминий, алюміній	220 g	5902801333804
OS-FRG20W2-00-MINI		czarny, black, черный, чорний			5902801333811



PL Oprawa ścienna
EN Wall light fixture
RU Настенный светильник
UK Настінний світильник

SANTO BIS



White

Black

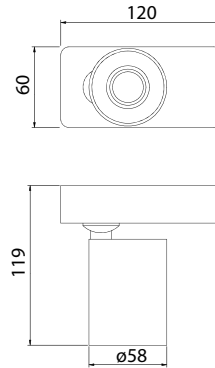

OS-SAN20WOK1B-10	max 20 W	biały, white, белый, білий	aluminium, aluminium, алюминий, алюміній	310 g	5902801336300
OS-SAN20WOK1B-00		czarny, black, черный, чорний			5902801336355



PL Oprawa sufitowa
EN Ceiling light fixture
RU Потолочный светильник
UK Стельовий світильник

SANTO BIS



White

Black

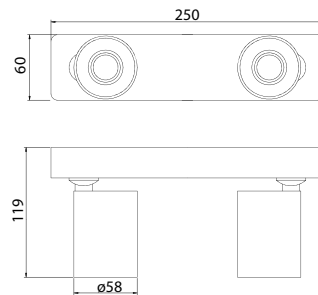

OS-SAN20WOK2B-10	max 2 x 20 W	biały, white, белый, білий	aluminium, aluminium, алюминий, алюміній	590 g	5902801336218
OS-SAN20WOK2B-00		czarny, black, черный, чорний			5902801336393



PL Oprawa ścienna
EN Wall light fixture
RU Настенный светильник
UK Настінний світильник



GU10



RENO

360°



White

Black

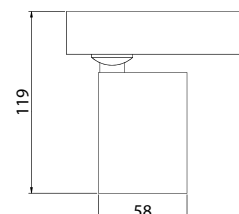
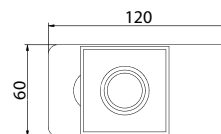

OS-REN20WKW1-10	max 20 W	biały, white, белый, білий	aluminium, aluminium, алюминий, алюміній	460 g	5902801244599
OS-REN20WKW1-00		czarny, black, черный, чорний			5902801243974



Decorative fixtures

PL Oprawa sufitowa
EN Ceiling light fixture
RU Потолочный светильник
UK Стельовий світильник



GU10



RENO

360°



White

Black

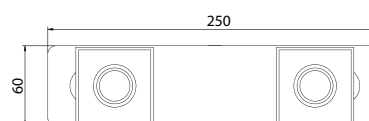

OS-REN20WKW2-10	max 2 x 20 W	biały, white, белый, білий	aluminium, aluminium, алюминий, алюміній	860 g	5902801244575
OS-REN20WKW2-00		czarny, black, черный, чорний			5902801244636



PL Oprawa sufitowa
EN Ceiling light fixture
RU Потолочный светильник
UK Стельовий світильник

VENETO



White

Black

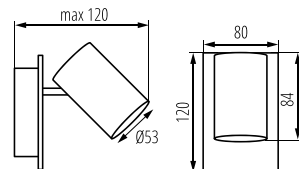

OS-VEN20WO1-00	max 20 W	czarny, black, черный, чорний	aluminium, aluminium, алюминий, алюміній	256 g	5902801442988
OS-VEN20WO1-10		biały, white, белый, білий			5902801443237



PL Oprawa sufitowa
EN Ceiling light fixture
RU Потолочный светильник
UK Стельовий світильник

VENETO



White

Black

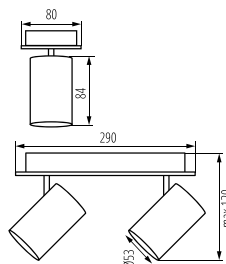

OS-VEN20WO2-00	max 2 X 20 W	czarny, black, черный, чорний	aluminium, aluminium, алюминий, алюміній	546 g	5902801402357
OS-VEN20WO2-10		biały, white, белый, білий			5902801443404



PL Oprawa sufitowa
EN Ceiling light fixture
RU Потолочный светильник
UK Стельовий світильник

VENETO

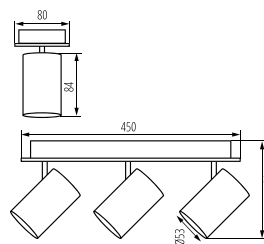

White

Black

Decorative fixtures

OS-VEN20WO3-00	max 3 x 20 W	czarny, black, черный, чорний	aluminium, aluminium, алюминий, алюміній	815 g	5902801443350
OS-VEN20WO3-10		biały, white, белый, білий			5902801443381



PL Oprawa sufitowa
EN Ceiling light fixture
RU Потолочный светильник
UK Стельовий світильник

VENETO

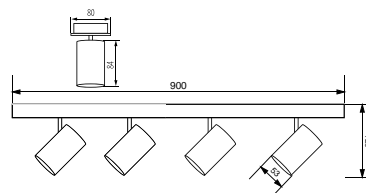

White

Black

OS-VEN20WO4-00	max 4 x 20 W	czarny, black, черный, чорний	aluminium, aluminium, алюминий, алюміній	1216 g	5902801442896
OS-VEN20WO4-10		biały, white, белый, білий			5902801402364



PL Oprawa sufitowa
EN Ceiling light fixture
RU Потолочный светильник
UK Стельовий світильник

VENETO

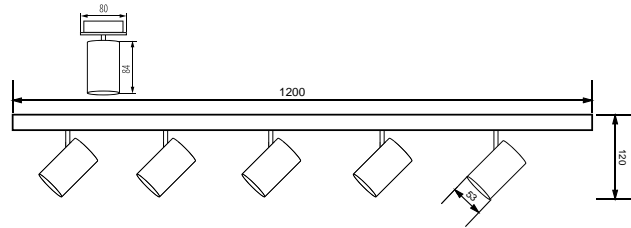

White

Black



OS-VEN20WO5-00	max 5 x 20 W	czarny, black, черный, чорний	aluminium, aluminium, алюминий, алюміній	1592 g	5902801441783
OS-VEN20WO5-10		biały, white, белый, білий			5902801402562



PL Oprawa sufitowa
EN Ceiling light fixture
RU Потолочный светильник
UK Стельовий світильник

VENETO



White

Black

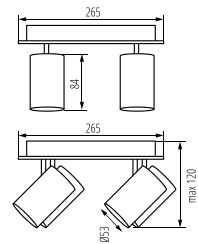

OS-VEN20WOK4-00	max 4 x 20 W	czarny, black, черный, чорний	aluminium, aluminium, алюминий, алюміній	1268 g	5902801401749
OS-VEN20WOK4-10		biały, white, белый, білий			5902801441660



PL Oprawa sufitowa
EN Ceiling fitting
RU Потолочный светильник
UK Стельовий світильник

NEW



ORIO



White

Black

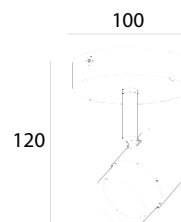

Folder	W	RoHS	Material	Weight	Barcode
OS-ORI-GU10-00	max. 20 W		czarny, black, черный, чорний	350 g	5902801391224
OS-ORI-GU10-10			biały, white, белый, білий	350 g	5902801391019



PL Oprawa sufitowa
EN Ceiling fitting
RU Потолочный светильник
UK Стельовий світильник

NEW



ORIO



White

Black

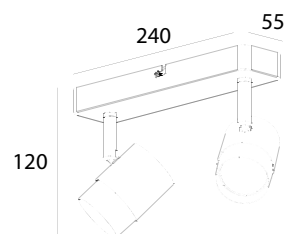

Folder	W	RoHS	Material	Weight	Barcode
OS-ORI-2GU10-00	max. 2 x 20 W		czarny, black, черный, чорний	520 g	5902801391170
OS-ORI-2GU10-10			biały, white, белый, білий	520 g	5902801391064



PL Oprawa sufitowa
EN Ceiling fitting
RU Потолочный светильник
UK Стельовий світильник

ORIO



White

Black

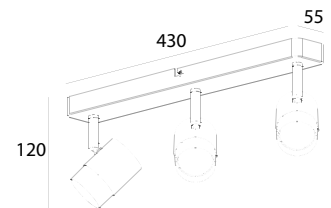

Folder	Wattage	Material	Weight	Barcode
OS-ORI-3GU10-00	max. 3 x 20 W	czarny, black, черный, чорний	820 g	5902801391187
OS-ORI-3GU10-10		biały, white, белый, білий	820 g	5902801391163



PL Oprawa sufitowa
EN Ceiling fitting
RU Потолочный светильник
UK Стельовий світильник

LUPO



White

Black

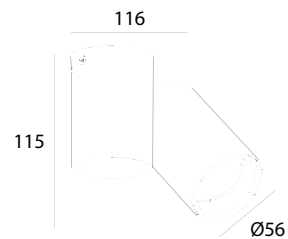

OS-LUP-GU10-00	max. 20 W	czarny, black, черный, чорний	aluminium, aluminium, алюминий, алюміній	310 g	5902801391279
OS-LUP-GU10-10		biały, white, белый, білий		310 g	5902801391309



PL Oprawa sufitowa
EN Ceiling fitting
RU Потолочный светильник
UK Стельовий світильник

LUPO



White

Black

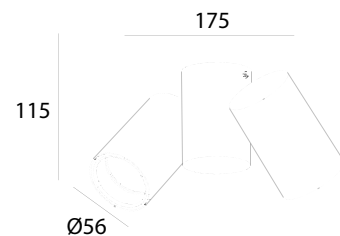

OS-LUP-2GU10-00	max. 2 x 20 W	czarny, black, черный, чорний	aluminium, aluminium, алюминий, алюміній	480 g	5902801391316
OS-LUP-2GU10-10		biały, white, белый, білий		480 g	5902801391439



PL Oprawa sufitowa
EN Ceiling light fixture
RU Потолочный светильник
UK Стельовий світильник

SAKURA



White

Black

Aksesoria,
Accessories,
Аксессуары,
Аксесуари:



ES111

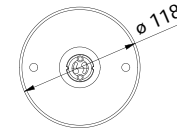

OS-SAKES111-10	max 20 W	biały, white, белый, білий	aluminium, aluminium, алюминий, алюміній	350 g	5902801274350
OS-SAKES111-00		czarny, black, черный, чорний			5902801274565



PL Oprawa sufitowa
EN Ceiling light fixture
RU Потолочный светильник
UK Стельовий світильник

SAKURA

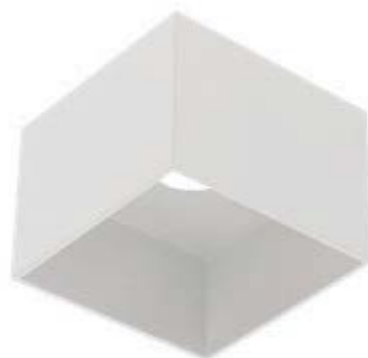

White

Black

Aksesoria,
Accessories,
Аксессуары,
Аксесуари:



ES111

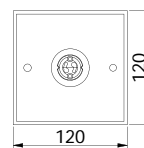

OS-SAKES111KW-10	max 20 W	biały, white, белый, білий	aluminium, aluminium, алюминий, алюміній	500 g	5902801274527
OS-SAKES111KW-00		czarny, black, черный, чорний			5902801274459



PL Oprawa sufitowa natynkowa
EN Surface ceiling fixture
RU Накладной светильник
UK Стельовий світильник поверхневого монтажу

PIREO N



White

Black

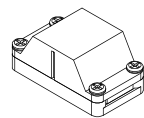

Aksesoria,
Accessories,
Аксессуары,
Аксесуари:
LZ-KOIZKO-10

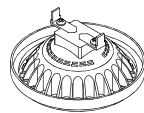

AR111

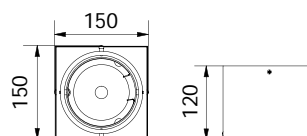

OP-PIREN1-00	max 50 W	stal, steel, сталь, сталь	biały, white, белый, білий	500 g	5902801248412
OP-PIREN1-20			czarny, black, черный, чорний		5901867191151



PL Oprawa sufitowa natynkowa
EN Surface ceiling fixture
RU Накладной светильник
UK Стельовий світильник поверхневого монтажу

PIREO N



White

Black

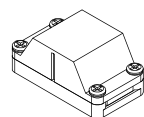

Aksesoria,
Accessories,
Аксессуары,
Аксесуари:
LZ-KOIZKO-10

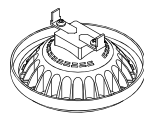

AR111

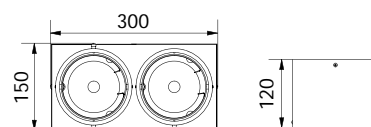

OP-PIREN2-00	max 2 x 50 W	stal, steel, сталь, сталь	biały, white, белый, білий	900 g	5902801248535
OP-PIREN2-20			czarny, black, черный, чорний		5901867191151





PL Oprawa sufitowa
EN Ceiling light fixture
RU Потолочный светильник
UK Стельовий світильник

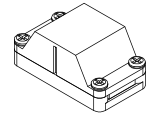

Aksesoria,
Accessories,
Аксессуары,
Аксесуари:
LZ-KO12KO-10

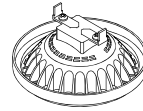

AR111

ISUMI

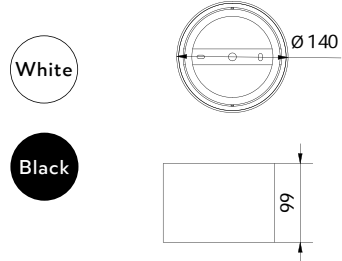

White

Black

Decorative fixtures



OS-ISUES111-10	max 50 W	biały, white, белый, білий	aluminium, aluminium, алюминий, алюміній	490 g	5902801268090
OS-ISUES111-00		czarny, black, черный, чорний			5902801268250



PL Oprawa sufitowa podtynkowa
EN Recessed ceiling fixture
RU Потолочный светильник встраиваемый
UK Стельовий світильник вбудований

PIREO

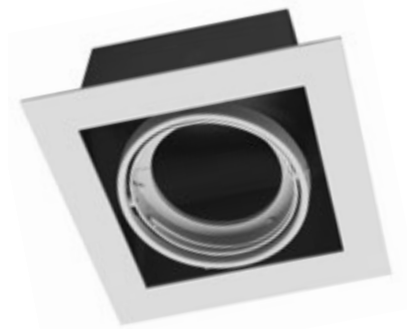

Black

Grey

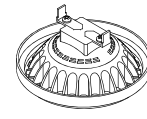

AR111

Aksesoria,
Accessories,
Аксесуари,
Аксесуари:

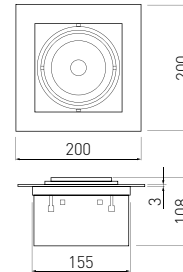

OP-PIREO1-20	max 50 W	stal, steel, сталь, сталь	czarny, black, черный, чорний	500 g	5901867128287
OP-PIREO1-81			szary, grey, серый, сірий		5901867128386



PL Oprawa sufitowa podtynkowa
EN Recessed ceiling fixture
RU Потолочный светильник встраиваемый
UK Стельовий світильник вбудований

PIREO



Black

Grey

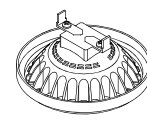

AR111

Aksesoria,
Accessories,
Аксесуари,
Аксесуари:

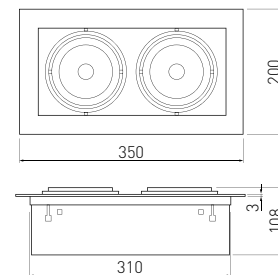

OP-PIREO2-20	max 2 x 50 W	stal, steel, сталь, сталь	czarny, black, черный, чорний	920 g	5901867128300
OP-PIREO2-81			szary, grey, серый, сірий		5901867128409



Decorative fixtures



PL Oprawa ścienna
EN Wall light fixture
RU Настенный светильник
UK Настінний світильник

CAMPIONE



White

Black

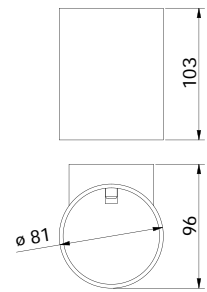

Decorative fixtures



OS-CAMD40WG9OK-10	max 40 W	biały, white, белый, білий	aluminium, aluminium, алюминий, алюміній	259 g	5902801412509
OS-CAMD40WG9OK-00		czarny, black, черный, чорний			5902801412578



PL Oprawa ścienna
EN Wall light fixture
RU Настенный светильник
UK Настінний світильник

CAMPIONE



White

Black

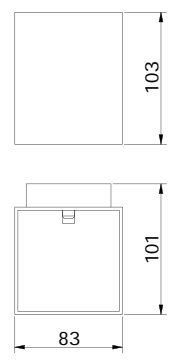

OS-CAMD40WG9KW-10	max 40 W	biały, white, белый, білий	aluminium, aluminium, алюминий, алюміній	234 g	5902801412547
OS-CAMD40WG9KW-00		czarny, black, черный, чорний			5902801438806







OPRAWY PUNKTOWE
SPOT LIGHT FIXTURES
ТОЧЕЧНЫЕ СВЕТИЛЬНИКИ
ТОЧКОВІ СВІТИЛЬНИКИ

PL Oprawa sufitowa punktowa
 EN Ceiling spot light fixture
 RU Потолочный точечный светильник
 UK Стельвий точковий світильник

PARMA

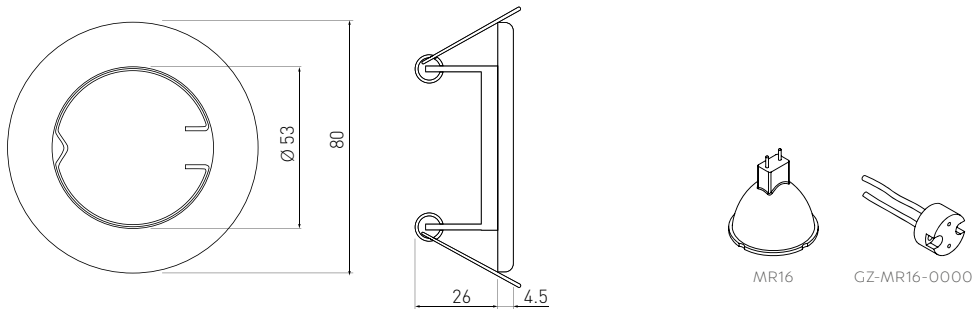

Aksesoria,
 Accessories,
 Аксессуары,
 Аксесуари:

MR16

GZ-MR16-0000

OP-PAST1-01	max 50 W	stal, steel, сталь, сталь	chrom, chrome, хром, хром	5908231384195
OP-PAST1-02			inox, inox, инокс, інюкс	5908231384232
OP-PAST1-10			biały, white, белый, білий	5908231384171
OP-PAST1-21			czarny chrom, black chrome, черный хром, чорний хром	5908231384188
OP-PAST1-30			patyna, weathered, патина, патина	5908231384201



Decorative fixtures



PL Oprawa sufitowa punktowa
EN Ceiling spot light fixture
RU Потолочный точечный светильник
UK Стельовий точковий світильник

PARMA III



OP-PADST3-10

OP-PADST3-01

OP-PADST3-52



OP-PADST3-61

OP-PADST3-21

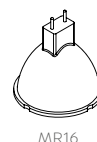
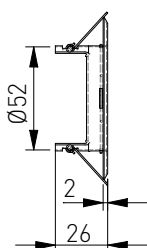
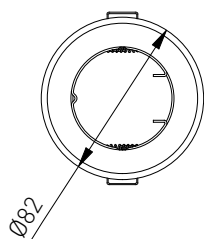

MR16



CZ-MR16-0000

Aksesoria,
Accessories,
Аксессуары,
Аксесуари:



OP-PADST3-01	max 50 W	stal, steel, сталь, сталь	chrom, chrome, хром, хром	60 g	5902801387524
OP-PADST3-10			biały, white, белый, білий		5902801387449
OP-PADST3-21			czarny chrom, black chrome, черный хром, чорний хром		5902801387760
OP-PADST3-52			satyna, satin, сатин, сатин		5902801387555
OP-PADST3-61			stare złoto, antique gold, старое золото, старе золото		5902801399794



PL Oprawa sufitowa punktowa uchylna
 EN Tilt-down ceiling fixture
 RU Потолочный точечный светильник с изменением наклона
 UK Стельвий точковий світильник поворотний

PARMA III



OP-PADRK3-10

OP-PADRK3-01

OP-PADRK3-52

OP-PADRK3-61

OP-PADRK3-21

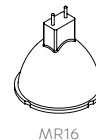
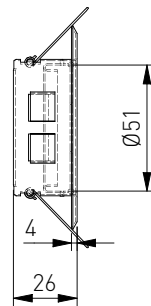
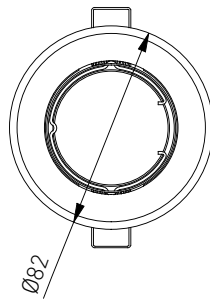

MR16

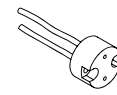

GZ-MR16-0000

Aksesoria,
Accessories,
Аксессуары,
Аксесуари:



OP-PADRK3-01	max 50 W	stal, steel, сталь, сталь	chrom, chrome, хром, хром	60 g	5902801387616
OP-PADRK3-10			biały, white, белый, білий		5902801387517
OP-PADRK3-21			czarny chrom, black chrome, черный хром, чорний хром		5902801387647
OP-PADRK3-52			satyna, satin, сатин, сатин		5902801387609
OP-PADRK3-61			stare złoto, antique gold, старое золото, старе золото		5902801387593



PL Oprawa sufitowa punktowa
 EN Ceiling spot light fixture
 RU Потолочный точечный светильник
 UK Стельовий точковий світильник

PORTO

Decorative fixtures

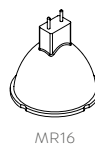
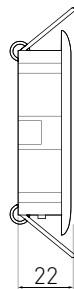
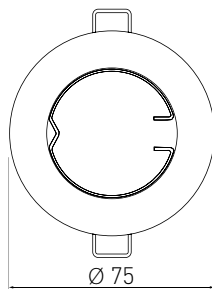

Aksesoria,
 Accessories,
 Аксессуары,
 Аксесуари:

Folder	W	Material	Finish	Weight	Barcode
OP-PROD3-01	max 50 W	aluminium, aluminium, алюминий, алюміній	chrom, chrome, хром, хром	40 g	5908231384225
OP-PROD3-02			inox, inox, инокс, інокс		5908231384249
OP-PROD3-21			czarny chrom, black chrome, черный хром, чорний хром		5908231384256
OP-PROD3-30			patyna, weathered, патина, патина		5908231384263



PL Oprawa sufitowa punktowa
EN Ceiling spot light fixture
RU Потолочный точечный светильник
UK Стельовий точковий світильник

PORTO

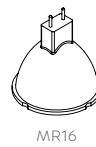
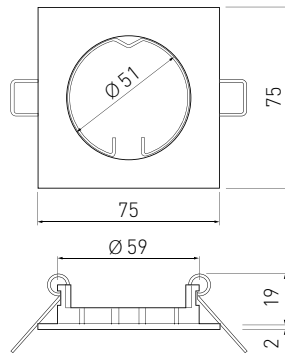

MR16

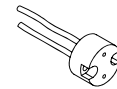

GZ-MR16-0000

Aksesoria,
Accessories,
Аксесуары,
Аксесуари:

Decorative fixtures

Folder	W	Material	Finish	Weight	Barcode
OP-PROD4-01	max 50 W	aluminium, aluminium, алюминий, алюміній	chrom, chrome, хром, хром	50 g	5901867101617
OP-PROD4-02			inox, inox, иннокс, іннокс		5901867101631
OP-PROD4-21			czarny chrom, black chrome, черный хром, чорний хром		5901867101624
OP-PROD4-30			patyna, weathered, патина, патина		5901867101648



PL Oprawa sufitowa punktowa uchylna
 EN Tilt-down ceiling fixture
 RU Потолочный точечный светильник с изменением наклона
 UK Стельовий точковий світильник поворотний

PORTO K



OP-PRAN5-01



OP-PRAN5-30



OP-PRAN5-21



OP-PRAN5-02

Decorative fixtures

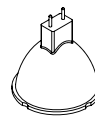
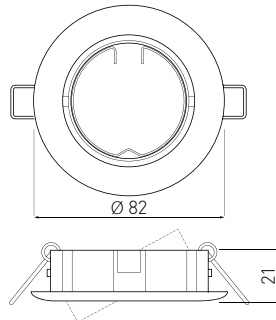

MR16

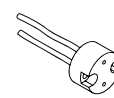

GZ-MR16-0000

Aksesoria,
Accessories,
Аксесуары,
Аксесуари:

OP-PRAN5-01	max 50 W	aluminium, aluminium, алюминий, алюміній	chrom, chrome, хром, хром	80 g	5908231384270	
OP-PRAN5-02			inox, inox, иннокс, иннокс		5908231384287	
OP-PRAN5-21			czarny chrom, black chrome, черный хром, чорний хром		5908231384294	
OP-PRAN5-30			patyna, weathered, патина, патина		5908231384300	



PL Oprawa sufitowa punktowa uchylna
 EN Tilt-down ceiling fixture
 RU Потолочный точечный светильник с изменением наклона
 UK Стельвий точковий світильник поворотний

PORTO K

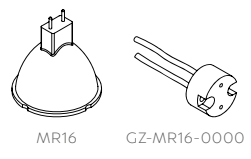
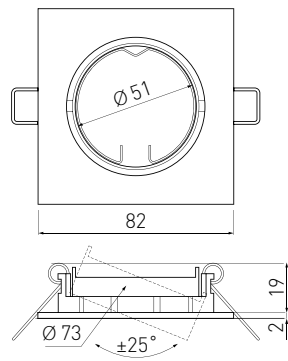

Aksesoria,
 Accessories,
 Аксессуары,
 Аксесуари:

Folder	W	Material	Finish	Weight	Barcode
OP-PRAN6-01	max 50 W	aluminium, aluminium, алюминий, алюміній	chrom, chrome, хром, хром	60 g	5901867101655
OP-PRAN6-02			inox, inox, инокс, інюкс		5901867101686
OP-PRAN6-21			czarny chrom, black chrome, черный хром, чорний хром		5901867101679
OP-PRAN6-30			patyna, weathered, патина, патина		5901867101662



Decorative fixtures

PL Oprawa sufitowa punktowa
EN Ceiling spot light fixture
RU Потолочный точечный светильник
UK Стельовий точковий світильник

BRILLANTE



White

Black

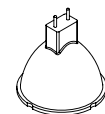

MR16

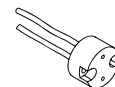

GZ-MR16-0000

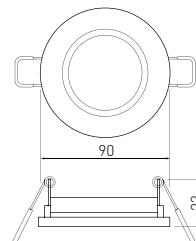

OP-OPROKR-10	max 50 W	szkło, glass, стекло, скло	biały, white, белый, білий	130 g	5901867109699
OP-OPROKR-21			czarny, black, черный, чорний		5901867109705



PL Oprawa sufitowa punktowa
EN Ceiling spot light fixture
RU Потолочный точечный светильник
UK Стельовий точковий світильник

BRILLANTE



White

Black

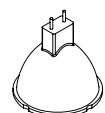

MR16

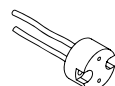

GZ-MR16-0000

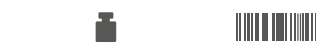
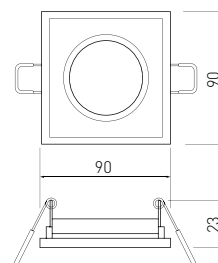

OP-OPRKWT-10	max 50 W	szkło, glass, стекло, скло	biały, white, белый, білий	130 g	5901867109675
OP-OPRKWT-21			czarny, black, черный, чорний		5901867109682





PL Oprawa sufitowa punktowa uchylna
 EN Tilt-down ceiling fixture
 RU Потолочный точечный светильник с изменением наклона
 UK Стельвий точковий світильник поворотний

MORENA



Silver

Black

Aksesoria,
Accessories,
Аксессуары,
Аксесуари:

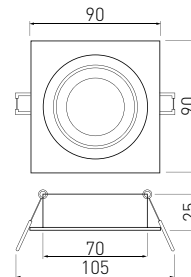
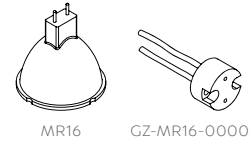

OP-OPRKW1-80	max 50 W	aluminium, aluminium, алюминий, алюміній	srebrny, silver, серебряный, срібний	50 g	5901867127839
OP-OPRKW1-20			czarny, black, черный, чорний		5901867127853



Decorative fixtures



PL Oprawa sufitowa punktowa uchylna
 EN Tilt-down ceiling fixture
 RU Потолочный точечный светильник с изменением наклона
 UK Стельвий точковий світильник поворотний

MORENA



Silver

Black

Aksesoria,
Accessories,
Аксессуары,
Аксесуари:

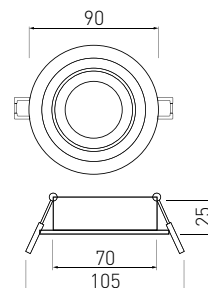
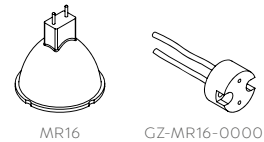

OP-OPROK1-80	max 50 W	aluminium, aluminium, алюминий, алюміній	srebrny, silver, серебряный, срібний	50 g	5901867127792
OP-OPROK1-20			czarny, black, черный, чорний		5901867127815



PL Oprawa sufitowa punktowa uchylna
 EN Tilt-down ceiling fixture
 RU Потолочный точечный светильник с изменением наклона
 UK Стельовий точковий світильник поворотний

CANNA



Aksesoria,
 Accessories,
 Аксессуары,
 Аксесуари:

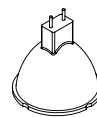

MR16

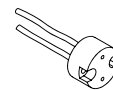

GZ-MR16-0000

White

Black

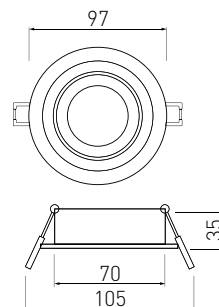

OP-CANOKB-10	max 50 W	aluminium, aluminium, алюминий, алюміній	biały, white, белый, білий	55 g	5902801480225
OP-CANOKC-00			czarny, black, черный, чорний		5902801478703



PL Oprawa sufitowa punktowa uchylna
 EN Tilt-down ceiling fixture
 RU Потолочный точечный светильник с изменением наклона
 UK Стельовий точковий світильник поворотний

CANNA



Aksesoria,
 Accessories,
 Аксессуары,
 Аксесуари:

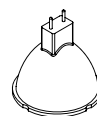

MR16

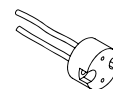

GZ-MR16-0000

White

Black

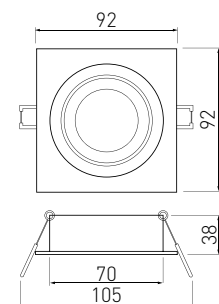

OP-CANKWB-10	max 50 W	aluminium, aluminium, алюминий, алюміній	biały, white, белый, білий	55 g	5902801489570
OP-CANKWC-00			czarny, black, черный, чорний		5902801489648





- PL Oprawa sufitowa punktowa uchylna
- EN Tilt-down ceiling fixture
- RU Потолочный точечный светильник с изменением наклона
- UK Стельвий точковий світильник поворотний

SALTO



Aksesoria,
Accessories,
Аксессуары,
Аксесуари:

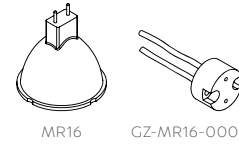

MR16 GZ-MR16-0000

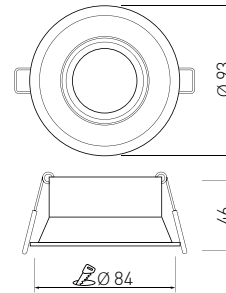

OP-SALOK-10	max 50 W	aluminium, aluminium, алюминий, алюміній	biały, white, белый, білий	98 g	5901867197573



- PL Oprawa sufitowa punktowa uchylna
- EN Tilt-down ceiling fixture
- RU Потолочный точечный светильник с изменением наклона
- UK Стельвий точковий світильник поворотний

SALTO



Aksesoria,
Accessories,
Аксессуары,
Аксесуари:

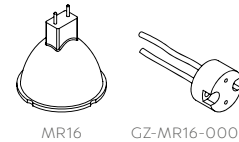

MR16 GZ-MR16-0000

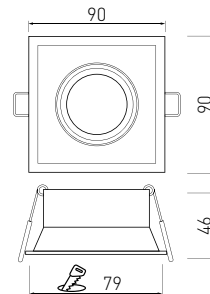

OP-SALKW-10	max 50 W	aluminium, aluminium, алюминий, алюміній	biały, white, белый, білий	98 g	5901867197580



Decorative fixtures



PL Oprawa sufitowa punktowa
EN Ceiling spot light fixture
RU Потолочный точечный светильник
UK Стельовий точковий світильник

Aksesoria,
Accessories,
Аксессуары,
Аксесуари:

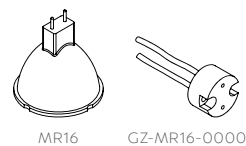

PALACE II

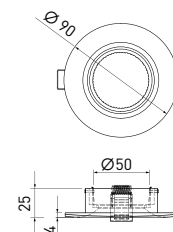
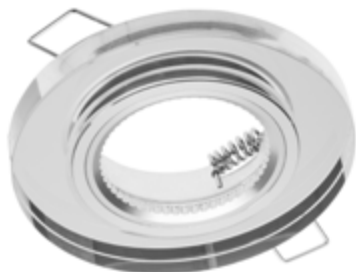

OP-PALACEDOK-10	max 50 W	szkło, glass, стекло, скло	biały, white, белый, білий	125 g	5902801130038
OP-PALACEDOK-20			czarny, black, черный, чорний		5902801130083



PL Oprawa sufitowa punktowa
EN Ceiling spot light fixture
RU Потолочный точечный светильник
UK Стельовий точковий світильник

Aksesoria,
Accessories,
Аксессуары,
Аксесуари:

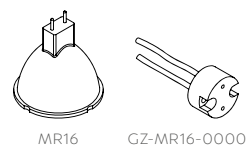

PALACE II

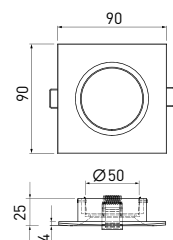
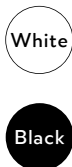
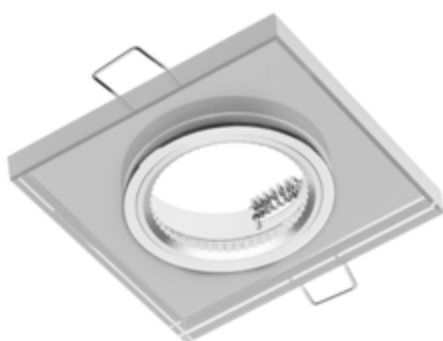

OP-PALACEDKW-10	max 50 W	szkło, glass, стекло, скло	biały, white, белый, білий	165 g	5902801130052
OP-PALACEDKW-20			czarny, black, черный, чорний		5902801130069





PL Oprawa sufitowa punktowa
 EN Ceiling spot light fixture
 RU Потолочный точечный светильник
 UK Стельовий точковий світильник

MAREA

Aksesoria,
 Accessories,
 Аксессуары,
 Аксесуари:

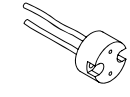
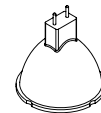

MR16

GZ-MR16-0000



White

Inox

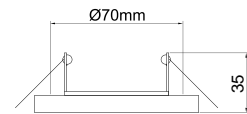
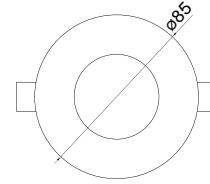

OP-MAROK-10	max 50 W	stal, steel, сталь, сталь	biały, white, белый, білий	95 g	5901867197597
OP-MAROK-02			inox, inox, инокс, інокс		5901867197603



PL Oprawa sufitowa punktowa
EN Ceiling spot light fixture
RU Потолочный точечный светильник
UK Стельовий точковий світильник

ARIES

Aksesoria,
Accessories,
Аксессуары,
Аксесуари:

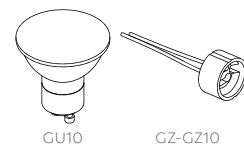

OP-ARIOK-11



OP-ARIOK-22



OP-ARIOK-23



OP-ARIOK-13



OP-ARIOK-11	max 20 W	PC	czarny, black, черный, чорний	50 g	5902801440564
OP-ARIOK-22			czarny chrom, black chrome, черный хром, чорний хром		5902801440250
OP-ARIOK-23			chrom, chrome, хром, хром		5902801440267
OP-ARIOK-13			zloto, gold, золото, золоту		5902801441295



Decorative fixtures

PL Oprawa sufitowa punktowa
EN Ceiling spot light fixture
RU Потолочный точечный светильник
UK Стельовий точковий світильник

ARIES

Aksesoria,
Accessories,
Аксессуары,
Аксесуари:



OP-ARIKW-11



OP-ARIKW-22



OP-ARIKW-23



OP-ARIKW-13



OP-ARIKW-11	max 20 W	PC	biały/czarny, white/black, белый/черный, білий/ чорний	60 g	5902801442582
OP-ARIKW-22			czarny chrom, black chrome, черный хром, чорний хром		5902801442810
OP-ARIKW-23			chrom, chrome, хром, хром		5902801441790
OP-ARIKW-13			zloto, gold, золото, золоту		5902801400131



PL Oprawa sufitowa punktowa
EN Ceiling spot light fixture
RU Потолочный точечный светильник
UK Стельовий точковий світильник

AURORA



OP-AUROKB-10



OP-AUROKS-52



OP-AUROKC-00

Aksesoria,
Accessories,
Аксессуары,
Аксесуари:

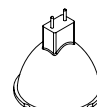

MR16

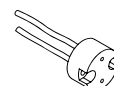

GZ-MR16-0000

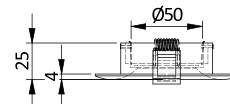
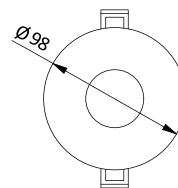

OP-AUROKB-10	max 50 W	aluminium, aluminium, алюминий, алюміній	biały, white, белый, білий	100 g	5902801238819
OP-AUROKS-52			satyna, satin, сатин, сатин		5902801239731
OP-AUROKC-00			czarny, black, черный, чорний		5902801267895



Decorative fixtures



PL Oprawa sufitowa punktowa
EN Ceiling spot light fixture
RU Потолочный точечный светильник
UK Стельовий точковий світильник

AURORA



OP-AURKWB-10



OP-AURKWS-52



OP-AURKWC-00

Aksesoria,
Accessories,
Аксессуары,
Аксесуари:

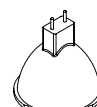

MR16

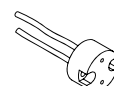

GZ-MR16-0000

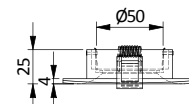
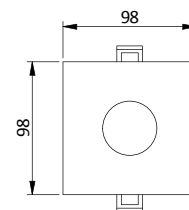

OP-AURKWB-10	max 50 W	aluminium, aluminium, алюминий, алюміній	biały, white, белый, білий	130 g	5902801239991
OP-AURKWS-52			satyna, satin, сатин, сатин		5902801240034
OP-AURKWC-00			czarny, black, черный, чорний		5902801267901





PL Oprawa sufitowa punktowa uchylna
 EN Tilt-down ceiling fixture
 RU Потолочный точечный светильник с изменением наклона
 UK Стельовий точковий світильник поворотний

LINTO



Aksesoria,
 Accessories,
 Аксессуары,
 Аксесуари:



MR16

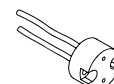

GZ-MR16-0000

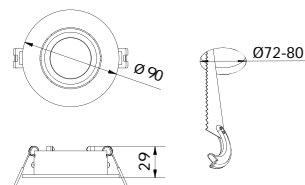

OP-LINTOK-00	max 20 W LED only	PC	czarny, black, черный, чорний	40 g	5902801320170
OP-LINTOK-10			biały, white, белый, білий		5902801320132
OP-LINTOK-52			biały/czarny, white/black, белый/черный, білий/чорний		5902801320484



Decorative fixtures

PL Oprawa sufitowa punktowa
 EN Ceiling spot light fixture
 RU Потолочный точечный светильник
 UK Стельовий точковий світильник

KERLA



Aksesoria,
 Accessories,
 Аксессуары,
 Аксесуари:



MR16

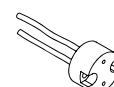

GZ-MR16-0000

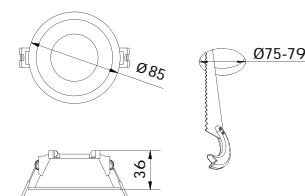

OP-KERLKW-10	max 20 W LED only	PC	biały, white, белый, білий	25 g	5902801320026
OP-KERLKW-00			czarny, black, черный, чорний		5902801320507



PL Oprawa sufitowa punktowa
 EN Ceiling spot light fixture
 RU Потолочный точечный светильник
 UK Стельовий точковий світильник

ELVA



OP-ELVAOBB-10	max 20 W	aluminium/szkło, aluminium/glass, алюминий/стекло, алюміній/скло	biały, white, белый, білий	145 g	5902801365997
OP-ELVAOCC-00			czarny, black, черный, чорний		5902801366017
OP-ELVAOBC-11			biały/czarny, white/black, белый/черный, білий/чорний		5902801366215
OP-ELVAOBM-13			biały/złoty, white/gold, белый/золото, білий/золото		5902801366239
OP-ELVAOCM-03			czarny/złoty, black/gold, черный/золото, чорний/золото		5902801366611





PL Oprawa sufitowa punktowa
EN Ceiling spot light fixture
RU Потолочный точечный светильник
UK Стельовий точковий світильник

ALESSIO

360°



OP-ALSOK-10



OP-ALSOK-52



OP-ALSOK-00

Aksesoria,
Accessories,
Аксессуары,
Аксесуари:

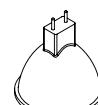

MR16

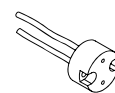

GZ-MR16-0000

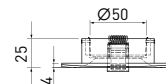
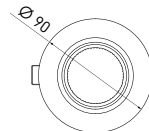

OP-ALSOK-10	max 50 W	aluminium, aluminium, алюминий, алюміній	biały, white, белый, білий	100 g	5902801242250
OP-ALSOK-00			czarny, black, черный, чорний		5902801242618
OP-ALSOK-52			satyna, satin, сатин, сатин		5902801242687



PL Oprawa sufitowa punktowa
EN Ceiling spot light fixture
RU Потолочный точечный светильник
UK Стельовий точковий світильник



ALESSIO

360°



OP-ALSKW-10



OP-ALSKW-52



OP-ALSKW-00

Aksesoria,
Accessories,
Аксессуары,
Аксесуари:

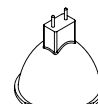

MR16

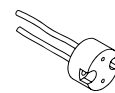

GZ-MR16-0000

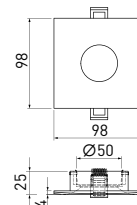

OP-ALSKW-10	max 50 W	aluminium, aluminium, алюминий, алюміній	biały, white, белый, білий	130 g	5902801243479
OP-ALSKW-00			czarny, black, черный, чорний		5902801242007
OP-ALSKW-52			satyna, satin, сатин, сатин		5902801243585







PL Oprawa sufitowa punktowa uchylna
 EN Tilt-down ceiling fixture
 RU Потолочный точечный светильник с изменением наклона
 UK Стельовий точковий світильник поворотний

RUBIO



OP-RUBIOKW1-10

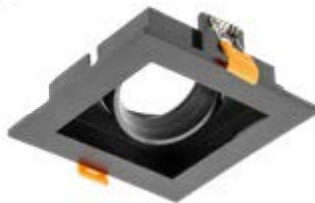

OP-RUBIOKW1-00

Aksesoria,
 Accessories,
 Аксессуары,
 Аксесуари:

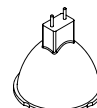

MR16

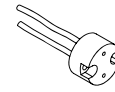

GZ-MR16-0000

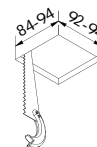
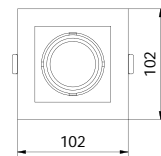

OP-RUBIOKW1-10	max 10 W LED only	PC	biały, white, белый, білий	42 g	5902801319655
OP-RUBIOKW1-00			czarny, black, черный, чорний		5902801319600



PL Oprawa sufitowa punktowa uchylna
 EN Tilt-down ceiling fixture
 RU Потолочный точечный светильник с изменением наклона
 UK Стельовий точковий світильник поворотний



RUBIO



OP-RUBIOKW2-10



OP-RUBIOKW2-00

Aksesoria,
 Accessories,
 Аксессуары,
 Аксесуари:

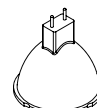

MR16

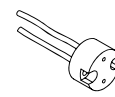

GZ-MR16-0000

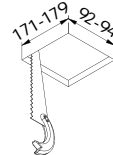
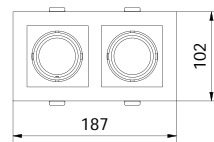

OP-RUBIOKW2-10	max 10 W LED only	PC	biały, white, белый, білий	84 g	5902801319686
OP-RUBIOKW2-00			czarny, black, черный, чорний		5902801319846





PL Oprawa schodowa LED
 EN Staircase LED fixture
 RU Лестничный светодиодный светильник
 UK Світильник для сходів

ESCADA

LED
TECHNOLOGY

inside

0,8 W

3 years warranty

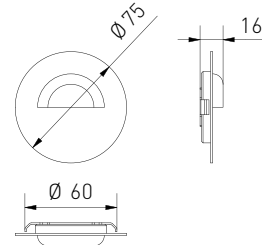

Decorative fixtures



LD-ESOA084-51	0,8 W	● 4000 K	70 lm	inox, inox, инокс, інокс	5902801211119

PL Oprawa schodowa LED
 EN Staircase LED fixture
 RU Лестничный светодиодный светильник
 UK Світильник для сходів

ESCADA

LED
TECHNOLOGY

inside

0,8 W

3 years warranty

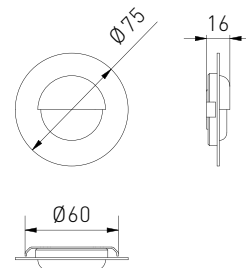

LD-ESOB084-51	0,8 W	● 4000 K	70 lm	inox, inox, инокс, інокс	5902801210990



PL Oprawa schodowa LED
EN Staircase LED fixture
RU Лестничный светодиодный светильник
UK Світильник для сходів

ESCADA

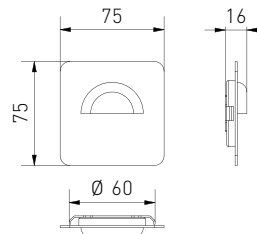
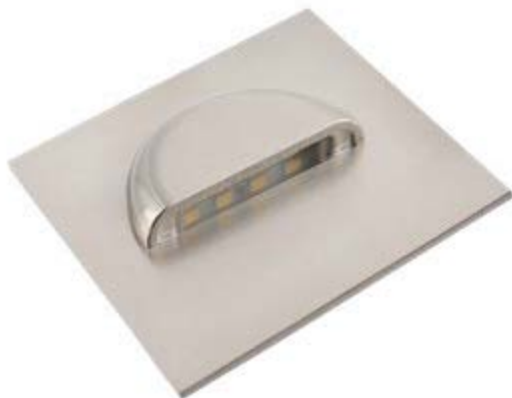

LED
LED LIGHTING

inside

0,8 W

3 years warranty

Decorative fixtures



LD-ESKA084-51	0,8 W	● 4000 K	70 lm	inox, inox, инокс, інюкс	5902801211270								

PL Oprawa schodowa LED
EN Staircase LED fixture
RU Лестничный светодиодный светильник
UK Світильник для сходів

ESCADA

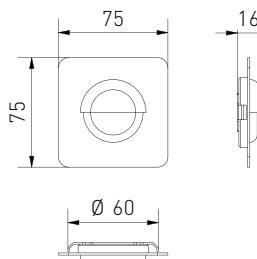

LED
LED LIGHTING

inside

0,8 W

3 years warranty

LD-ESKB084-51	0,8 W	● 4000 K	70 lm	inox, inox, инокс, інюкс	5902801211201								

PL Oprawa na wycięgniку
EN Fixture with arm
RU Светильник типа „дуга”
UK Світлодіодний світильник на консолі

KATANI

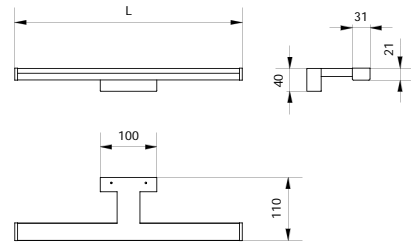

Folder	W	lm	Color	mm	Material	Barcode
LD-KAT400-01	8 W	640 lm	● 4000 K	400	chrom, chrome, хром, хром	5902801399077
LD-KAT600-01	12 W	960 lm		600		5902801399299
LD-KAT400-10	8 W	640 lm		400	czarny, black, черный, чорний	5902801399428
LD-KAT600-10	12 W	960 lm		600		5902801399336
LD-KAT400-00	8 W	640 lm		400	biały, white, белый, білий	5902801399695
LD-KAT600-00	12 W	960 lm		600		5902801399664



Decorative fixtures





OPRAWY OGRODOWE I ELEWACYJNE
GARDEN AND WALL FIXTURES
САДОВЫЕ И ФАСАДНЫЕ СВЕТИЛЬНИКИ
САДОВІ ТА ФАСАДНІ СВІТИЛЬНИКИ

PL Oprawa elewacyjna
EN Facade fixture
RU Фасадный светильник
UK Фасадний світильник



MILAN



OS-MILA00A-00



OS-MILA00U-00

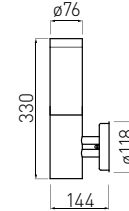

OS-MILA00A-00

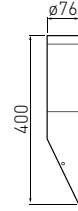

OS-MILA00U-00



OS-MILA00A-00	max 20 W	stal nierdzewna + PC, stainless steel + PC, нержавеющая сталь + ПК, нержавіюча сталь + PC	inox, inox, інокс, інокс	502 g	5901867199218
OS-MILA00U-00				358 g	5901867199195



PL Oprawa ogrodowa
EN Garden luminaire
RU Садовый светильник
UK Садовий світильник

MILAN



OS-MILA45P-00



OS-MILA10P-00

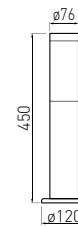

OS-MILA45P-00

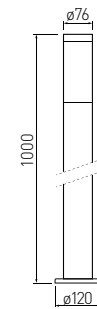

OS-MILA10P-00



OS-MILA10P-00	max 20 W	stal nierdzewna + PC, stainless steel + PC, нержавеющая сталь + ПК, нержавіюча сталь + PC	inox, inox, інокс, інокс	876 g	5901867199256
OS-MILA45P-00				463 g	5901867199232



Decorative fixtures



PL Oprawa ogrodowa
EN Garden luminaire
RU Садовый светильник
UK Садовий світильник

CORTA

Decorative fixtures



OS-COR0UA-30

OS-CORDUA-30

OS-CORP40-30

OS-CORP40G-30

OS-CORP36G-30

OS-CORP80-30

OS-CORP80G-30

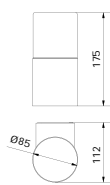

OS-COR0UA-30

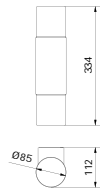

OS-CORDUA-30

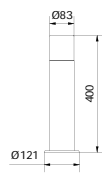

OS-CORP40-30

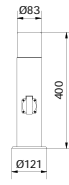

OS-CORP40G-30

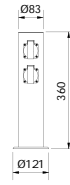

OS-CORP36G-30

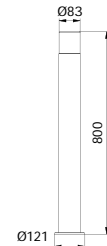

OS-CORP80-30

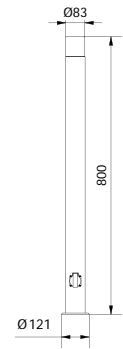

OS-CORP80G-30

OS-COR0UA-30		max 25 W	aluminium + PC, aluminum + PC, алюминий + PC, алюміній + PC,	444 g	5902801288951
OS-CORDUA-30		2 x max 25 W		700 g	5902801289002
OS-CORP40-30		max 25 W		711 g	5902801288944
OS-CORP40G-30				711 g	5902801227417
OS-CORP36G-30		-		630 g	5902801336973
OS-CORP80-30		max 25 W		1307 g	5902801289088
OS-CORP80G-30				1307 g	5902801309113





KERTA

Decorative fixtures



OS-KERTOUA-30



OS-KERTP40-30



OS-KERTP80-30

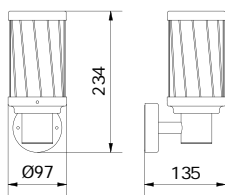

OS-KERTOUA-30

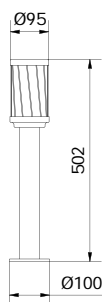

OS-KERTP40-30

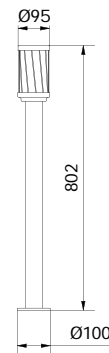

OS-KERTP80-30

OS-KERTOUA-30	max 12 W	aluminium + PC, aluminum + PC, алюминий + PC, алюміній + PC,	690 g	5902801227325	
OS-KERTP40-30			700 g	5902801227455	
OS-KERTP80-30			1350 g	5902801227493	







KEMI

Decorative fixtures



OS-KEMIOUA-30

OS-KEMIP40-30

OS-KEMIP80-30

OS-KEMIP40G-30

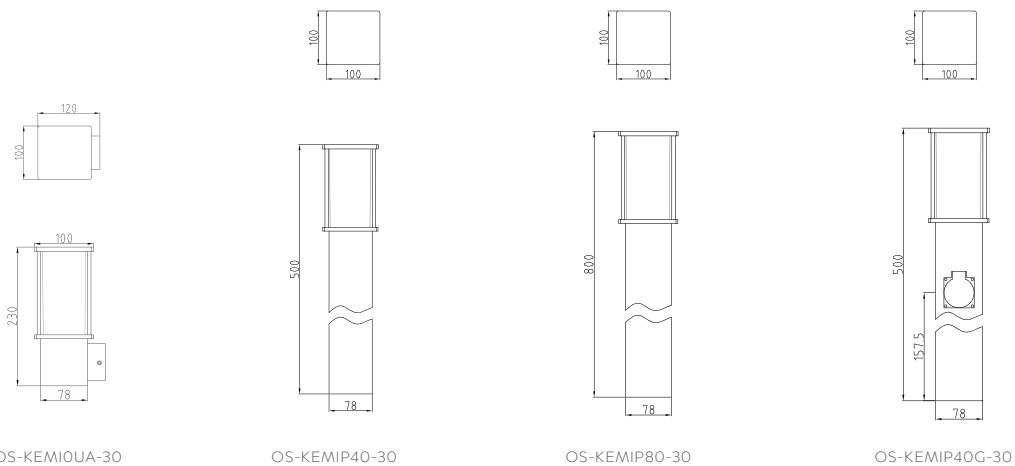

OS-KEMIOUA-30

OS-KEMIP40-30

OS-KEMIP80-30

OS-KEMIP40G-30

OS-KEMIOUA-30	max 15 W	stal nierdzewna + PC, stainless steel + PC, нержавеющая сталь + ПК, нержавіюча сталь + PC	780 g	5902801336225	
OS-KEMIP40-30			1120 g	5902801336102	
OS-KEMIP80-30			1370 g	5902801336294	
OS-KEMIP40G-30*			1820 g	5902801336003	





PL Oprawa ogrodowa
EN Garden fitting
RU Садовый светильник
UK Садовий світильник

MEDIO

Decorative fixtures



OS-MED0AU-30

OS-MED0AUP-30

OS-MEDP50-30

OS-MEDP50P-30

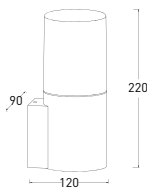

OS-MED0AU-30

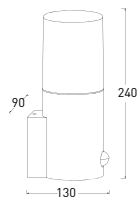

OS-MED0AUP-30

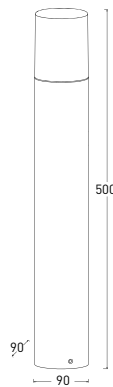

OS-MEDP50-30



OS-MEDP50P-30

OS-MED0AU-30	MAX 15 W	aluminium + PC, aluminum + PC, алюминий + PC, алюміній + PC,	670 g	5902801337475
OS-MED0AUP-30*			720 g	5902801337406
OS-MEDP50-30			1100 g	5902801363566
OS-MEDP50P-30*			1150g	5902801363542







PL Oprawa ogrodowa
EN Garden luminaire
RU Садовый светильник
UK Садовий світильник

LARGO

Decorative fixtures



OS-LARG0UA-30

OS-LARGP40-30

OS-LARGP40G-30

OS-LARGP40P-30

OS-LARGP36G-30

OS-LARGP80-30

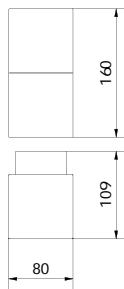

OS-LARG0UA-30

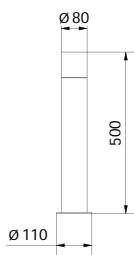

OS-LARGP40-30

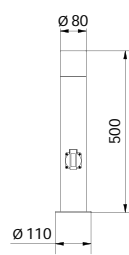

OS-LARGP40G-30
OS-LARGP40P-30
OS-LARGP36G-30

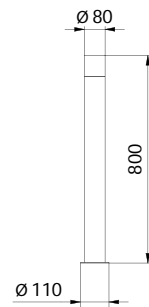

OS-LARGP80-30

OS-LARG0UA-30	max 15 W	44	aluminium + PC, aluminum + PC, алюминий + PC, алюминій + PC,	-	450 g	5902801335259
OS-LARGP40-30					820 g	5902801335686
OS-LARGP80-30					1120 g	5902801335990
OS-LARGP40G-30					990 g	5902801336232
OS-LARGP36G-30	-	54		schuko x4	830 g	5902801337055
OS-LARGP40P-30*	max 15 W	44		-	1005 g	5902801336997





PL Oprawa ogrodowa
EN Garden fitting
RU Садовый светильник
UK Садовий світильник

TORO

Decorative fixtures



OS-TOR0AU-00



OS-TORP50-00



OS-TORP80-00

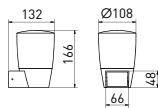

OS-TOR0AU-00

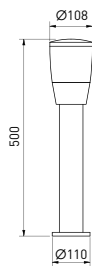

OS-TORP50-00

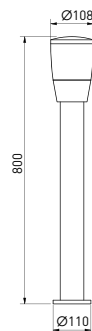

OS-TORP80-00

OS-TOR0AU-00	max 15 W	aluminium + PC, aluminum + PC, алюминий + PC, алюміній + PC,	czarny, black, черный, чорний	540 g	5902801337048
OS-TORP50-00				700 g	5902801337000
OS-TORP80-00				870 g	5902801337116



PL Oprawa ogrodowa
EN Garden luminaire
RU Садовый светильник
UK Садовий світильник

LUSTINO



OS-USTI0UD-30

OS-USTIP40-30

OS-USTIP80-30

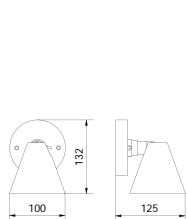

OS-USTI0UD-30

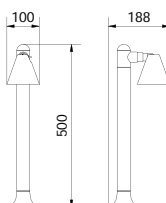

OS-USTIP40-30

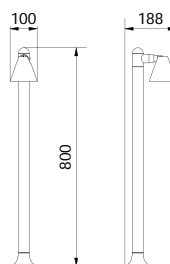

OS-USTIP80-30

Decorative fixtures



OS-USTI0UD-30	max 20 W	aluminium, aluminium, алюминий, алюміній	5902801335327
OS-USTIP40-30			5902801335273
OS-USTIP80-30			5902801335396



PL Oprawa ogrodowa
EN Garden fitting
RU Садовый светильник
UK Садовий світильник

GRANDE



OS-GRA0DA-00



OS-GRA0UA-00



OS-GRA00P-00



OS-GRA31P-00

Decorative fixtures

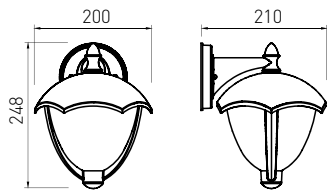

OS-GRA0DA-00

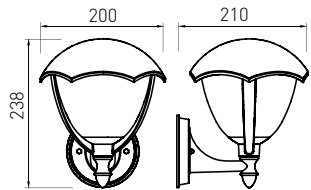

OS-GRA0UA-00

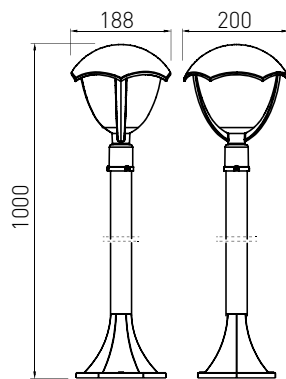

OS-GRA00P-00

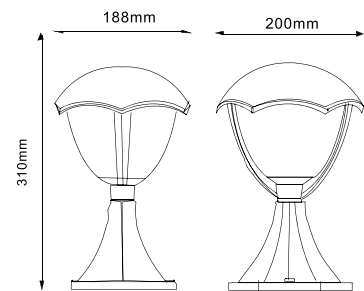

OS-GRA31P-00

OS-GRA0DA-00	max 60 W	aluminium + PC, aluminum + PC, алюминий + PC,	czarny, black, черный, чорний	627 g	5901867199133
OS-GRA0UA-00				1020 g	5901867199119
OS-GRA00P-00				627 g	5901867199157
OS-GRA31P-00				540 g	5902801337390





MARINA



Decorative fixtures

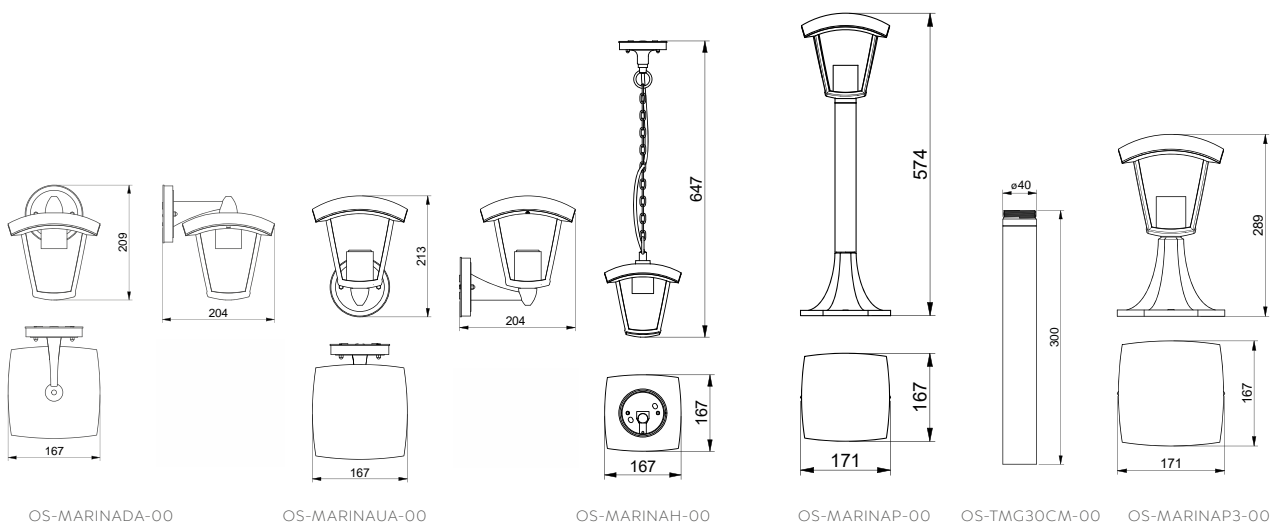

Model	Power	Material	Color	Weight	Barcode
OS-MARINAP3-00	max 20 W	aluminium + PC, aluminum + PC, алюминий + PC, алюміній + PC,	czarny, black, черный, чорний	750 g	5902801205804
OS-MARINADA-00					5902801205583
OS-MARINAUA-00					5902801205637
OS-MARINAP-00					5902801205798
OS-TMG30CM-00	-	aluminium, aluminium, алюминий, алюміній		200 g	5902801224645
OS-MARINAH-00	max 20 W	aluminium + szkło, aluminium + glass, алюминий + стекло, алюміній + скло		750 g	5902801205743





PL Oprawa elewacyjna
EN Facade fixture
RU Фасадный светильник
UK Фасадний світильник

TOSKANA



Black

Grey

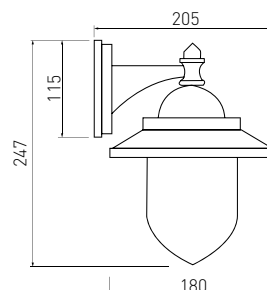

OS-TOSODA-00	max 60 W	aluminium + PC, aluminum + PC, алюминий + PC, алюминій + PC,	czarny, black, черный, чорний	627 g	5901867199171
OS-TOSODA-80			szary, grey, серый, сірий		5902801456718



PL Oprawa elewacyjna
EN Facade fixture
RU Фасадный светильник
UK Фасадний світильник

ASTRIT



Black

Grey

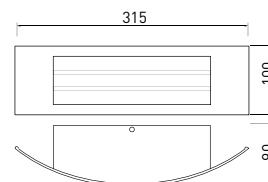

OS-ASTRITE27-20	max 14 W	tworzywo, plastic, пластмасса, пластик	czarny, black, черный, чорний	450 g	5901867190826
OS-ASTRITE27-80			szary, grey, серый, сірий		5901867190802





PL Oprawa elewacyjna
EN Facade fixture
RU Фасадный светильник
UK Фасадний світильник



ESO



Inox

Black

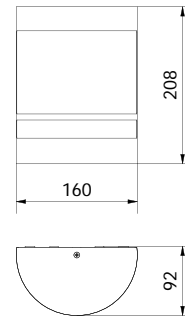

Zestaw liter i cyfr w komplecie.
Set of letters and numbers included.
Набор букв и цифр включен.
Набір букв і цифр включений.



OS-ESOE2711-80	max 11 W	PC	inox, inox, инокс, інокс	600 g	5902801227363
OS-ESOE2711-20			czarny, black, черный, чорний		5902801227318

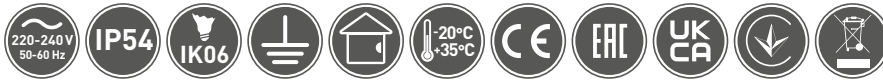

PL Oprawa elewacyjna
EN Facade fixture
RU Фасадный светильник
UK Фасадний світильник



VENTANA



OS-VENTANAH-00



OS-VENTANAU-00

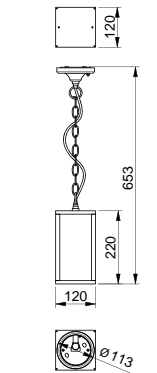

OS-VENTANAH-00

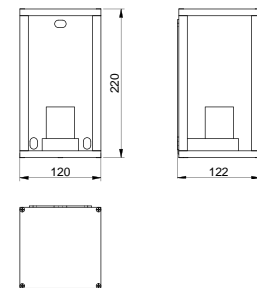

OS-VENTANAU-00

OS-VENTANAH-00	max 20 W	aluminium + szkło, aluminium + glass, алюминий + стекло, алюміній + скло	czarny, black, черный, чорний	1312g	5902801225055
OS-VENTANAU-00				1140g	5902801282423



A cylindrical, illuminated sign is mounted on a wall. The sign is white with a glowing yellow interior. It features three horizontal, brushed metal bands: one at the top, one in the middle, and one at the bottom. The text "5A" is printed in a bold, black, sans-serif font on the upper half of the sign. The sign is set against a wall of light-colored, square tiles with a speckled pattern.

5A

PL Oprawa sufitowa
EN Ceiling fitting
RU Потолочный светильник
UK Стельовий світильник

LENTO

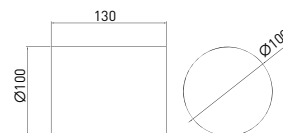

OS-LEN100OKG-30	MAX. 35 W	aluminium + PC, aluminum + PC, алюминий + PC, алюміній + PC,	czarny, black, черный, чорний	440 g	5902801337383



PL Oprawa sufitowa
EN Ceiling fitting
RU Потолочный светильник
UK Стельовий світильник

LENTO

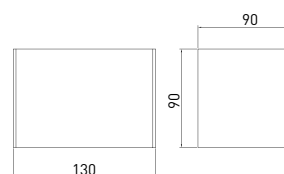

OS-LEN100KKG-30	MAX. 35 W	aluminium + PC, aluminum + PC, алюминий + PC, алюміній + PC,	czarny, black, черный, чорний	500 g	5902801337499



PL Oprawa sufitowa
EN Ceiling fitting
RU Потолочный светильник
UK Стельовий світильник

RIVEN

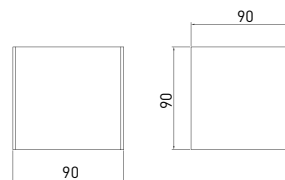

OS-RIV102KKG-30	MAX 35 W	aluminium + PC, aluminum + PC, алюминий + PC, алюміній + PC,	czarny, black, черный, чорний	380 g	5902801337468



PL Oprawa sufitowa
EN Ceiling fitting
RU Потолочный светильник
UK Стельовий світильник

RIVEN

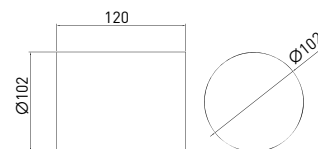

OS-RIV102OKG-30	MAX 35 W	aluminium + PC, aluminum + PC, алюминий + PC, алюміній + PC,	czarny, black, черный, чорний	400 g	5902801337451



Decorative fixtures

PL Oprawa elewacyjna
EN Facade fixture
RU Фасадный светильник
UK Фасадний світильник

VALLA

LED
EcoLight

inside

8-12 W

3 years
warranty

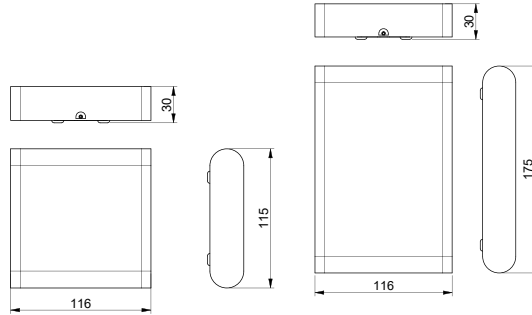

LD-VALLA8W-40

LD-VALLA12W-40

Decorative fixtures



Folder	Wattage	Material	Color	Weight	Barcode
LD-VALLA8W-40	8 W	aluminium + szkło, aluminium + glass, алюминий + стекло, алюміній + скло	czarny, black, черный, чорний	359 g	5902801205613
LD-VALLA12W-40	12 W			555 g	5902801203299



PL Oprawa elewacyjna
EN Facade fixture
RU Фасадный светильник
UK Фасадний світильник

MISSOURI



Grey

Black

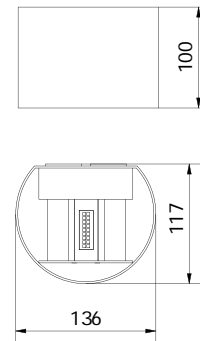
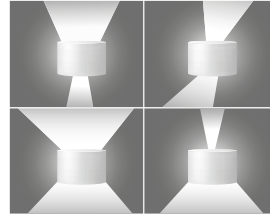

LD-MISS7WOC-NB	7 W	540 lm	aluminium, aluminium, алюминий, алюміній	czarny, black, черный, чорний	600 g	5902801239434
LD-MISS7WOS-NB				szary, grey, серый, сірий		5902801316821

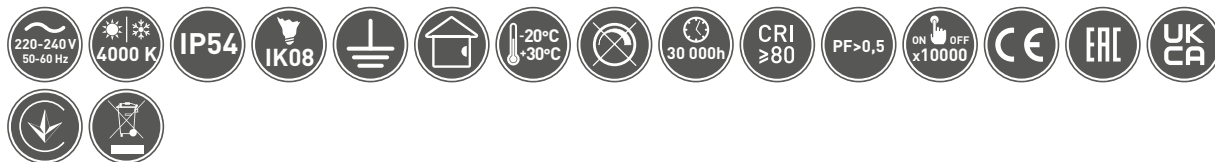

PL Oprawa elewacyjna
EN Facade fixture
RU Фасадный светильник
UK Фасадний світильник

MISSOURI



Grey

Black

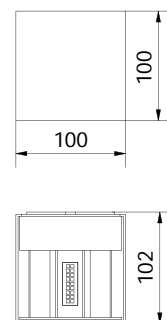
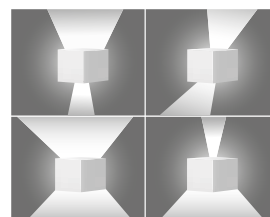

LD-MISS7WKC-NB	7 W	540 lm	aluminium, aluminium, алюминий, алюміній	czarny, black, черный, чорний	600 g	5902801239441
LD-MISS7WKS-NB				szary, grey, серый, сірий		5902801316807

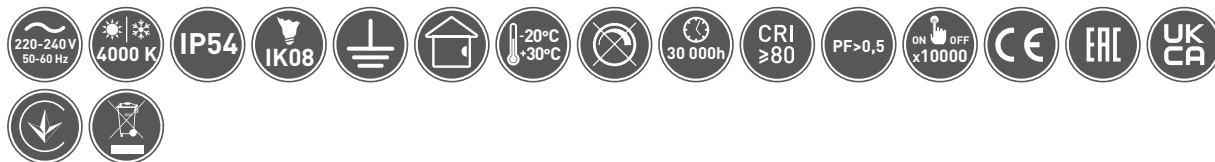

PL Oprawa elewacyjna
EN Facade fixture
RU Фасадный светильник
UK Фасадний світильник



CANTI

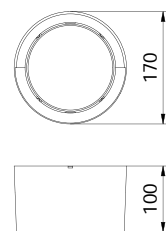

Decorative fixtures



LD-CANTI12WOK-40	12 W	1000 lm	PC	czarny, black, черный, чорний	510 g	5902801319648

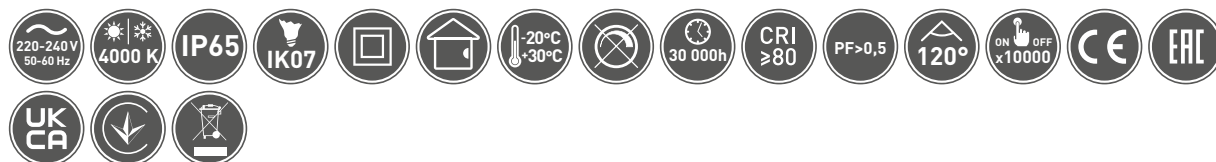

PL Oprawa elewacyjna
EN Facade fixture
RU Фасадный светильник
UK Фасадний світильник



CANTI

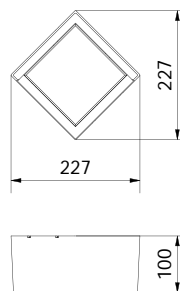

LD-CANTI12WKW-40	12 W	1000 lm	PC	czarny, black, черный, чорний	600 g	5902801320583

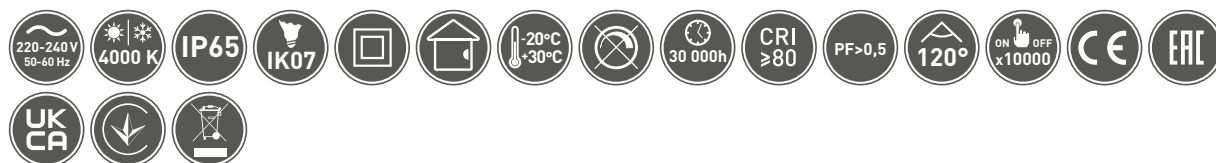



PL Oprawa elewacyjna
EN Facade fixture
RU Фасадный светильник
UK Фасадний світильник

PARIS



White

Black

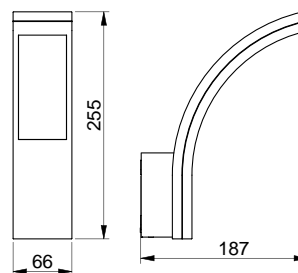

LED

inside

10 W

3 years warranty



LD-PAR10W40BC-00	10 W	PC	biały, white, белый, білий	450 g	5902801234262
LD-PAR10W40BC-10			czarny, black, черный, чорний		5902801226106



PL Oprawa elewacyjna
EN Facade fixture
RU Фасадный светильник
UK Фасадний світильник

PARIS



White

Black

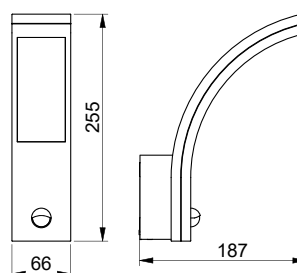

LED

inside

10 W

motion sensor

3 years warranty



LD-PAR10W40-00	10 W	PC	biały, white, белый, білий	450 g	5902801282065
LD-PAR10W40-10			czarny, black, черный, чорний		5902801282072





PL Oprawa elewacyjna
EN Facade fixture
RU Фасадный светильник
UK Фасадний світильник



NESSA



Grey
Black

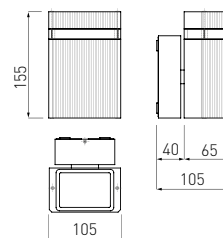

INFO



LD-NESSAGU10J-80	max 50 W	stop aluminium + szkło hartowane, aluminium alloy + tempered glass, сплав алюминия + закаленное стекло, алюминий + гартоване скло	szary, grey, серый, сірий	jednokierunkowa, unidirectional, односторонний	850 g	5901867122230
LD-NESSAGU10J-20			czarny, black, черный, чорний			5901867122254



PL Oprawa elewacyjna
EN Facade fixture
RU Фасадный светильник
UK Фасадний світильник



NESSA



Grey
Black

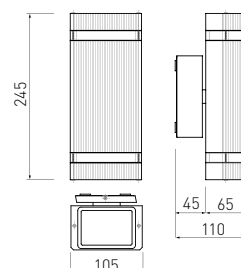

INFO



LD-NESSAGU10D-80	max 2 x 50 W	stop aluminium + szkło hartowane, aluminium alloy + tempered glass, сплав алюминия + закаленное стекло, алюминий + гартоване скло	szary, grey, серый, сірий	dwukierunkowa, bidirectional, двусторонний	1100 g	5901867122193
LD-NESSAGU10D-20			czarny, black, черный, чорний			5901867122216





PL Oprawa elewacyjna
EN Facade fixture
RU Фасадный светильник
UK Фасадний світильник



SILVA



Grey

Black

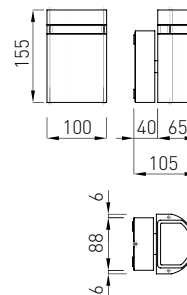

Folder	W	3D	Light	INFO	Weight	Barcode
LD-SILVAGU10J-80	max 50 W	stop aluminium + szkło hartowane, aluminium alloy + tempered glass, сплав алюминия + закаленное стекло, алюміній + гартоване скло	szary, grey, серый, сірий	jednokierunkowa, unidirectional, однонаправленный, односторонний	800 g	5901867122117
LD-SILVAGU10J-20			czarny, black, черный, чорний			5901867122131



Decorative fixtures



PL Oprawa elewacyjna
EN Facade fixture
RU Фасадный светильник
UK Фасадний світильник



SILVA



Grey

Black

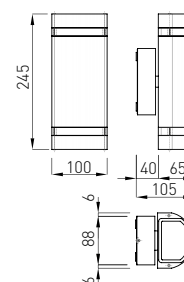

Folder	W	3D	Light	INFO	Weight	Barcode
LD-SILVAGU10D-80	max 2 x 50 W	stop aluminium + szkło hartowane, aluminium alloy + tempered glass, сплав алюминия + закаленное стекло, алюміній + гартоване скло	szary, grey, серый, сірий	dwukierunkowa, bidirectional, двунаправленный, двосторонний	1100 g	5901867122155
LD-SILVAGU10D-20			czarny, black, черный, чорний			5901867122179





PL Oprawa elewacyjna
EN Facade fixture
RU Фасадный светильник
UK Фасадний світильник



TIAGO



Inox

Black

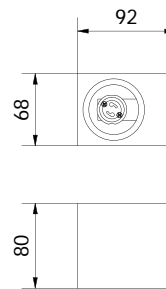

LD-TIAGOGU10J-20KW	max 35 W	stop aluminium + szkło hartowane, aluminium alloy + tempered glass, алюминия + закаленное стекло, алюміній + гартоване скло	czarny, black, черный, чорний	275 g	5902801211102
LD-TIAGOGU10J-01KW			inox, inox, инокс, інокс		5902801203305



Decorative fixtures



PL Oprawa elewacyjna
EN Facade fixture
RU Фасадный светильник
UK Фасадний світильник



TIAGO



Inox

Black

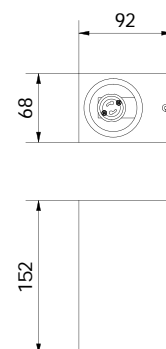

LD-TIAGOGU10D-20KW	2 x max 35 W	stop aluminium + szkło hartowane, aluminium alloy + tempered glass, сплав алюминия + закаленное стекло, алюміній + гартоване скло	czarny, black, черный, чорний	668 g	5902801212352
LD-TIAGOGU10D-01KW			inox, inox, инокс, інокс		5902801203329





PL Oprawa elewacyjna
EN Facade fixture
RU Фасадный светильник
UK Фасадний світильник



TIAGO



Black

Inox

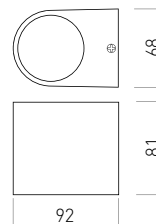

INFO



LD-TIAGOGU10J-20	1 x max 35 W	stop aluminium + szkło hartowane, aluminium alloy + tempered glass, сплав алюминия + закаленное стекло, алюминій + гартоване скло	czarny, black, черный, чорний	jednokierunkowa, unidirectional, однонаправленный, односторонній	300 g	5901867162144
LD-TIAGOGU10J-01			inox, inox, инокс, інокс			5902801255984



PL Oprawa elewacyjna
EN Facade fixture
RU Фасадный светильник
UK Фасадний світильник



TIAGO



Black

Inox

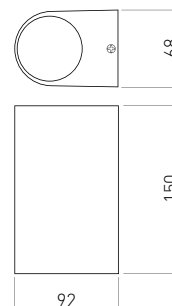

INFO



LD-TIAGOGU10D-20	2 x max 35 W	stop aluminium + szkło hartowane, aluminium alloy + tempered glass, сплав алюминия + закаленное стекло, алюміній + гартоване скло	czarny, black, черный, чорний	dwukierunkowa, bidirectional, двунаправленный, двосторонній	470 g	5901867162151
LD-TIAGOGU10D-01			inox, inox, инокс, інокс			5902801256042



PL Oprawa elewacyjna
EN Facade fixture
RU Фасадный светильник
UK Фасадний світильник

BALEO



LD-BALE27-00



LD-BALGU10-0S

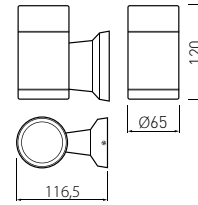

LD-BALGU10-0S

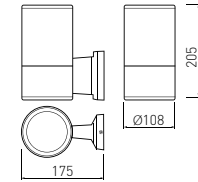

LD-BALE27-00



INFO



LD-BALGU10-0S	1 x max 10 W	GU10	stop aluminium + szkło hartowane, aluminium alloy + tempered glass, сплав алюминия + закаленное стекло, алюміній + гартоване скло	szary, grey, серый, сірий	jednokierunkowa, unidirectional, однонаправленный, односторонний	300 g	5901867136879
LD-BALE27-00	1 x max 40 W	E27				600 g	5901867136916



PL Oprawa elewacyjna
EN Facade fixture
RU Фасадный светильник
UK Фасадний світильник

BALEO



LD-BA2E27-00



LD-BA2GU10-0M

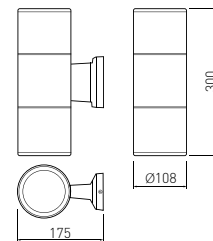

LD-BA2E27-00

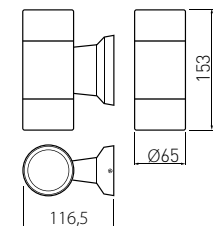

LD-BA2GU10-0M



INFO



LD-BA2E27-00	2 x max 40 W	E27	stop aluminium + szkło hartowane, aluminium alloy + tempered glass, сплав алюминия + закаленное стекло, алюміній + гартоване скло	szary, grey, серый, сірий	dwukierunkowa, bidirectional, двунаправленный, двосторонний	900 g	5901867136930
LD-BA2GU10-0M	2 x max 10 W	GU10				400 g	5901867136893



PL Oprawa ogrodowa
EN Festoon Harness
RU Садовая гирлянда
UK Садова гірлянда

GIRLANDA

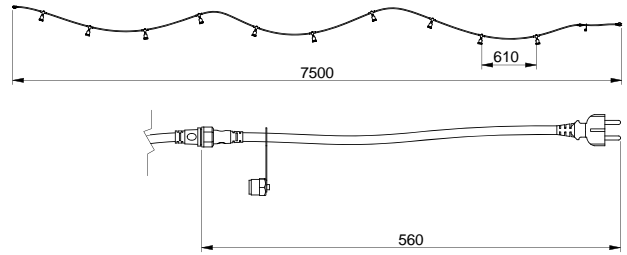

Decorative fixtures

AE-GR610-10	max. 10 x 10 W	max 15	tworzywo, plastic, пластмасса, пластик	czarny, black, черный, чорний	1812 g	5902801281242



PL Oprawa ogrodowa
EN Festoon Harness
RU Садовая гирлянда
UK Садова гірлянда

GIRLANDA

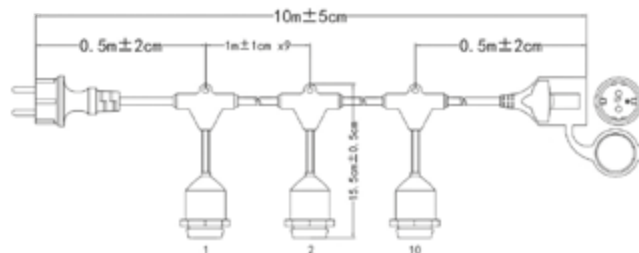

AE-GIR10-10	max. 10 x 10 W	max 15	tworzywo, plastic, пластмасса, пластик	czarny, black, черный, чорний	1360 g	5902801337017
-------------	----------------	--------	---	-------------------------------	--------	---------------



Decorative fixtures



DIEGO

360°



Black

Grey

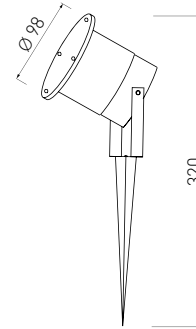

OS-DIEGOGU10-20	max 35 W	aluminium, aluminium, алюминий, алюміній	czarny, black, черный, чорний	330 g	5901867185716
OS-DIEGOGU10-80			szary, grey, серый, сірий		5902801256493





PL Oprawa ogrodowa
 EN Garden luminaire
 RU Садовый светильник
 UK Садовий світильник

MARMO

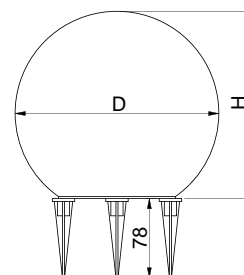

Model	Power (W)	Material	Dimensions (D x H mm)	Weight (g)	Barcode
OS-MARMO25-00	max 35 W	PE	ø250 x 230	812 g	5902801211294
OS-MARMO28-00			ø280 x 250	950 g	5902801224706
OS-MARMO38-00			ø380 x 350	1700 g	5902801224683



Decorative fixtures



PL Oprawa ogrodowa
EN Garden luminaire
RU Садовый светильник
UK Садовий світильник

GRAZIE



Black

Inox

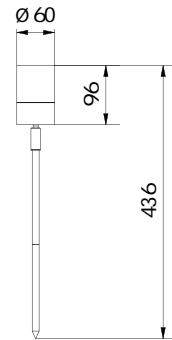

Decorative fixtures

OS-GRAZIEGU10-20	max 20 W	aluminium, aluminium, алюминий, алюміній	czarny, black, черный, чорний	5902801335181
OS-GRAZIEGU10-01			inox, inox, инокс, інокс	5902801335419



PL Oprawa dogruntowa
EN In-ground light fixture
RU Тротуарно-наездной светильник
UK Ґрунтовий світильник

ALFA



ON-ALFAOGU10-06



ON-ALFAKGU10-06

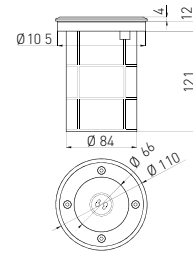

ON-ALFAOGU10-06

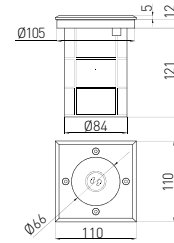

ON-ALFAKGU10-06



ON-ALFAOGU10-06	max 50 W	pierścień - stal nierdzewna, korpus - aluminium, puszka montażowa - PC, ring - stainless steel, body - aluminum, assembly box - PC, кольцо - нержавеющей сталь, корпус - алюминий, монтажная чашка - поликарбонат, кільце - нержавіюча сталь, корпус - алюміній, кріпильна коробка - PC	500 g	5901867109934
ON-ALFAKGU10-06			700 g	5901867109958



PL Oprawa wbudowana podłogowa
EN Recessed floor light fixture
RU Напольный встраиваемый светильник
UK Ґрунтовий світильник

ALFA MINI



ON-ALFAOGU10-06



ON-ALFAKGU10-06

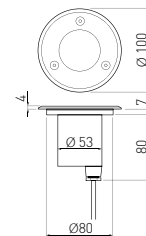

ON-ALFAOGU10-06

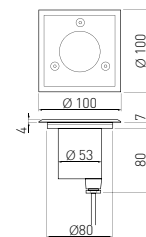

ON-ALFAKGU10-06



ON-ALFAOGU10-06-MINI	max 10 W	pierścień - stal nierdzewna; obudowa - aluminium, ring - stainless steel; enclosure - aluminium, кольцо - нержавеющей сталь; корпус - алюминий, кільце - нержавіюча сталь; корпус - алюміній	370 g	5901867119889
ON-ALFAKGU10-06-MINI				5901867119896



PL Oprawa dogruntowa
EN In-ground light fixture
RU Тротуарно-наездной светильник
UK Ґрунтовий світильник

BETA



ON-BETAOGU10RK-06

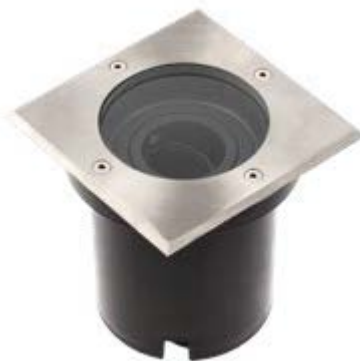

ON-BETAKGU10RK-06

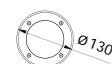

ON-BETAOGU10RK-06

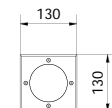

ON-BETAKGU10RK-06



ON-BETAOGU10RK-06	max 50 W	pierścień - stal nierdzewna, korpus - aluminium, puszka montażowa - PC, ring - stainless steel, body - aluminum, assembly box - PC, кольцо - нержавеющей сталь, корпус - алюминий, монтажная чашка - поликарбонат, кільце - нержавіюча сталь, корпус - алюміній, крипильна коробка - PC	1070 g	5902801335341
ON-BETAKGU10RK-06			1210 g	5902801335488



PL Pokrywka jednokierunkowa i dwukierunkowa do oprawy dogruntowej
EN Unidirectional & bidirectional diffuser shroud for in-ground light fixtures
RU Крышка однонаправленная и двунаправленная для наездного светильника
UK Одностороння і двостороння кришка для тротуарного світильника

ALFA-O



ON-ALFAO-C1W



ON-ALFAO-C2W



INFO



ON-ALFAO-C1W	ON-ALFAOGU10-06	pokrywka jednokierunkowa, unidirectional diffuser shroud, однаправленная крышка дифузор односторонний	stal nierdzewna, stainless steel,	5901867122360
ON-ALFAO-C2W	ON-ALFAKGU10-06	pokrywka dwukierunkowa, bidirectional diffuser shroud, двунаправленная крышка, дифузор двосторонний	нержавеющая сталь, нержавіюча сталь	5901867122384





LAMPKI
DESK LAMPS
НАСТОЛЬНЫЕ ЛАМПЫ
ЛАМПИ НАСТІЛЬНІ

PL Lampka biurkowa LED
EN Desktop LED lamp
RU Настольная светодиодная лампа
UK Настільна світлодіодна лампа

GALACTIC LED

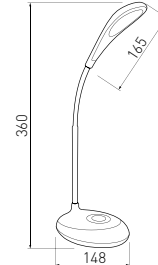

LED
technology



LB-GAL3WRU-10	3 W	120 lm	● 4000 K	tworzywo, plastic, пластмасса, пластик	biały, white, белый, білий	314 g	5902801010392
---------------	-----	--------	----------	--	----------------------------	-------	---------------



PL Lampka biurkowa LED
EN Desktop LED lamp
RU Настольная светодиодная лампа
UK Настільна світлодіодна лампа

GALACTIC LED

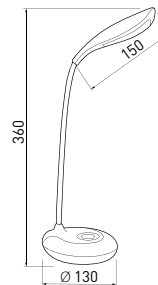

LED
technology



LB-GAL5WRU-10	5 W	240 lm	● 4000 K	tworzywo, plastic, пластмасса, пластик	biały, white, белый, білий	554 g	5902801010408
---------------	-----	--------	----------	--	----------------------------	-------	---------------



Decorative fixtures

PL Lampka biurkowa LED
EN Desktop LED lamp
RU Настольная светодиодная лампа
UK Настільна світлодіодна лампа

HALLEY

360°



White

Black

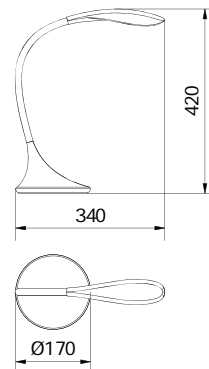

LED
LEDNOLC000...

inside

50%
dimming

Decorative fixtures

LB-HAL8W-00-DEC	8 W	500 lm	● 4000 K	tworzywo, plastic, пластмасса, пластик	biały, white, белый, білий	1660 g	5902801345432
LB-HAL8W-10-DEC					czarny, black, черный, чорний		5902801345487



PL Lampka biurkowa LED
EN Desktop LED lamp
RU Настольная светодиодная лампа
UK Настільна світлодіодна лампа

FROGY

360°

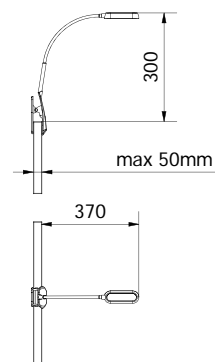

LED
LEDNOLC000...

inside

LB-FRO5W-00-DEC	5 W	300 lm	● 4000 K	ABS	biały, white, белый, білий	520 g	5902801301650





PL Lampka biurkowa LED
EN Desktop LED lamp
RU Настольная светодиодная лампа
UK Настільна світлодіодна лампа

FLOWER

360°

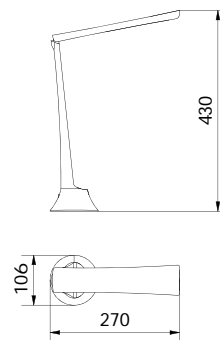

Decorative fixtures

LB-FLOW4W-06-DEC	4 W	240 lm	4000 K	ABS	biały/czarny, white/black, белый/черный, білий/чорний	740 g	5902801301261



PL Lampka biurkowa LED
EN Desktop LED lamp
RU Настольная светодиодная лампа
UK Настільна світлодіодна лампа

HIKARI

360°



White

Black

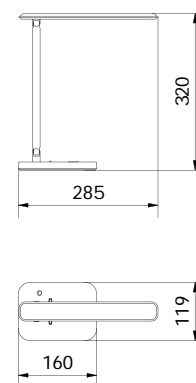

TRI-COLOR

LB-HIK6WCCT-00	6 W	400 lm	PC	biały, white, белый, білий	520 g	5902801228360
LB-HIK6WCCT-10				czarny, black, черный, чорний		5902801228100



PL Lampka biurkowa LED
 EN Desktop LED lamp
 RU Настольная светодиодная лампа
 UK Настільна світлодіодна лампа

IZUKA

360°



White

Black

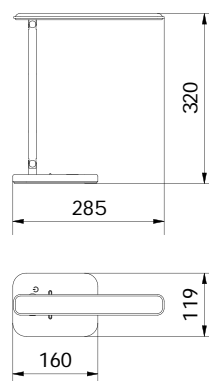

LB-IZK6WCCT-00	6 W	400 lm	PC	biały, white, белый, білий	520 g	5902801226960
LB-IZK6WCCT-10				czarny, black, черный, чорний		5902801226120



PL Lampka biurkowa LED
EN Desktop LED lamp
RU Настольная светодиодная лампа
UK Настільна світлодіодна лампа

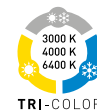

LED
LIGHTING



GALACTIC LED



LB-GAL5WMO-10	5 W	240 lm	tworzywo, plastic, пластмасса, пластик	biały, white, белый, білий	732 g	5902801010514



Decorative fixtures



PL Lampka biurkowa LED
EN Desktop LED lamp
RU Настольная светодиодная лампа
UK Настільна світлодіодна лампа



LED
LIGHTING



LINEAR



White

Black

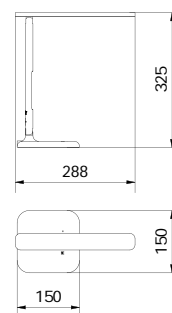

LB-LIN7W-00-DEC	7 W	420 lm	● 2700 K	ABS	biały, white, белый, білий	750 g	5902801345524
LB-LIN7W-10-DEC			● 4500 K				● 6500 K





PL Lampka biurkowa LED
EN Desktop LED lamp
RU Настольная светодиодная лампа
UK Настільна світлодіодна лампа

GALE



White

Black

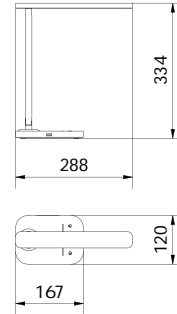

Decorative fixtures

LB-GAL8W-00-DEC	8 W	550 lm	4000 K	ABS	biały, white, белый, білий	785 g	5902801346125
LB-GAL8W-10-DEC					czarny, black, черный, чорний		5902801346156



PL Lampka biurkowa LED
 EN Desktop LED lamp
 RU Настольная светодиодная лампа
 UK Настільна світлодіодна лампа

TRITTON



White

Black

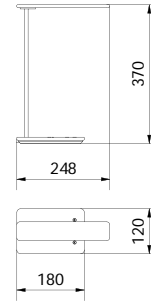

LED
LIGHT SOURCE



FOUR - CO LOR



LB-TRIT6W-00-DEC	6 W	340 lm	● 2700 K	aluminium + ABS, aluminium + ABS, алюминий + ABS, алюміній + ABS	biały, white, белый, білий	800 g	5902801346484
LB-TRIT6W-10-DEC			● 3000 K		czarny, black, черный, чорний		5902801346415



Decorative fixtures



PL Lampka biurkowa LED
EN Desktop LED lamp
RU Настольная светодиодная лампа
UK Настільна світлодіодна лампа

BRESSI



Gold
Black

Grey

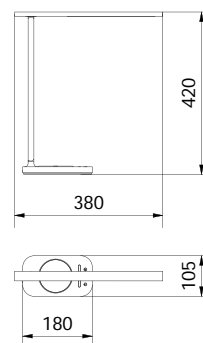

LED



Decorative fixtures

LB-BRE8W-11-DEC	8 W	450 lm	<ul style="list-style-type: none"> ● 3000 K ● 4000 K ● 6400 K 	aluminium + ABS, aluminium + ABS, алюминий + ABS, алюміній + ABS	czarny/złoty, black/gold, черный/золото, черный/золото	750 g	5902801346736
LB-BRE8W-15-DEC					szary, grey, серый, сірий		5902801346750



PL Lampka biurkowa LED
EN Desktop LED lamp
RU Настольная светодиодная лампа
UK Настільна світлодіодна лампа

HELIN



Blue

Pink

Grey

White

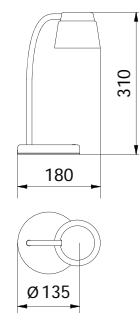

LED



LB-HEL6W-25-DEC	6 W	350 lm	● 4000 K	ABS	niebieski, blue, синий, синій	800 g	5902801346507
LB-HEL6W-20-DEC					różowy, pink, розовый, рожевий		5902801346651
LB-HEL6W-15-DEC					szary, grey, серый, сірий		5902801308505
LB-HEL6W-00-DEC					biały, white, белый, білий		5902801346699





PL Lampka biurkowa LED
EN Desktop LED lamp
RU Настольная светодиодная лампа
UK Настільна світлодіодна лампа

LONEOS

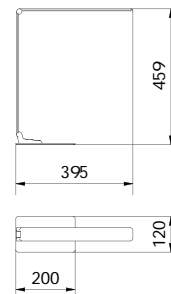

LED
TECHNOLOGY



TRI-COLOR

Decorative fixtures

LB-LON12W-10-DEC	12 W	700 lm	<ul style="list-style-type: none"> ● 3000 K ● 4000 K ● 6000 K 	ABS	czarny, black, черный, чорний	875 g	5902801346323



PL Lampka biurkowa LED
EN Desktop LED lamp
RU Настольная светодиодная лампа
UK Настільна світлодіодна лампа

NEW

LED
TECHNOLOGY



MONUM



LB-MON3W-02-DEC

LB-MON3W-40-DEC

LB-MON3W-41-DEC

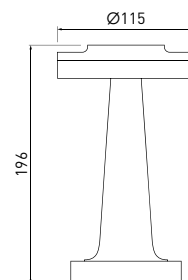

LB-MON3W-40-DEC	3 W	200 lm	● 3000 K	aluminium, aluminium, алюминий, алюміній	złoto szczotkowane, brushed gold, шлифованное золото, шліфоване золото	400 g	5902801379253
LB-MON3W-02-DEC				inox, inox, инокс, інокс	5902801379260		
LB-MON3W-41-DEC				miedzь szczotkowana, brushed cooper, щоткована медь, ліфована мідь	5902801379345		



PL Lampka biurkowa LED
EN Desktop LED lamp
RU Настольная светодиодная лампа
UK Настільна світлодіодна лампа

ARCHITECTO



White

Black

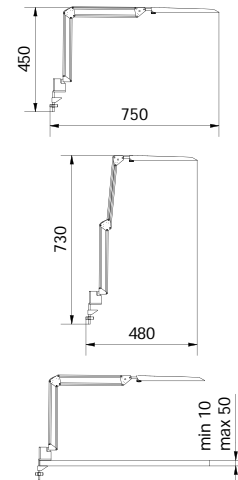

LB-ARCH8W-00	8 W	600 lm	● 4000 K	ABS	biały, white, белый, білий	650 g	5902801357749
LB-ARCH8W-10					czarny, black, черный, чорний		5902801357756

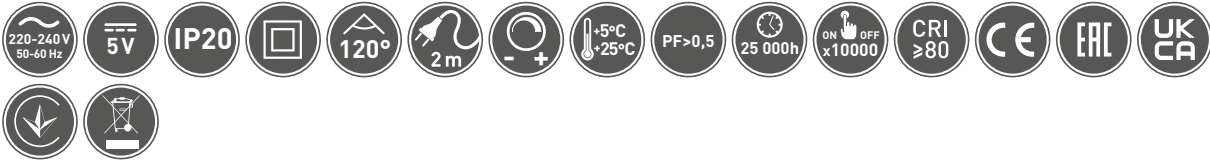

PL Lampka biurkowa LED
EN Desktop LED lamp
RU Настольная светодиодная лампа
UK Настільна світлодіодна лампа

VENETO



White

Black

NEW



LB-VEN20WO-00	max 20 W	aluminium, aluminium, алюминий, алюміній	biały, white, белый, білий	825 g	5902801442568
LB-VEN20W-10			czarny, black, черный, чорний		5902801403392



Decorative fixtures

PL Lampa podłogowa
EN Floor lamp
RU Торшер
UK Підлогова лампа

VASALIA

LED
E27/E26



Decorative fixtures

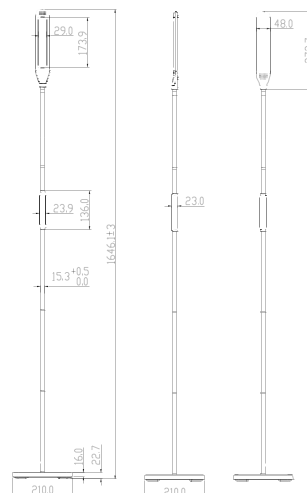

LP-VAS8W-10-DEC	8 W	450 lm	<ul style="list-style-type: none"> ● 2700 K ● 4500 K ● 6500 K 	ABS	czarny, black, черный, чорний	2250 g	5902801346774
-----------------	-----	--------	--	-----	-------------------------------	--------	---------------





PL Lampa podłogowa
EN Floor lamp
RU Торшер
UK Підлогова лампа

YORK



Decorative fixtures



White

Black

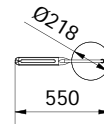
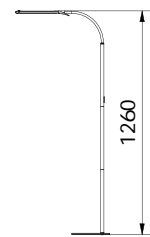

LP-YORK10W-00-DEC	10 W	900 lm	● 3000 K	ABS + metal,	biały, white, белый, білий	2670 g	5902801301551
LP-YORK10W-10-DEC			● 4500 K	ABS + metal,	czarny, black, черный, чорний		5902801301834
			● 6000 K	ABS + металл, ABS + металл			





BENFICA 2



E27



E14

Decorative fixtures



White

Grey

Black

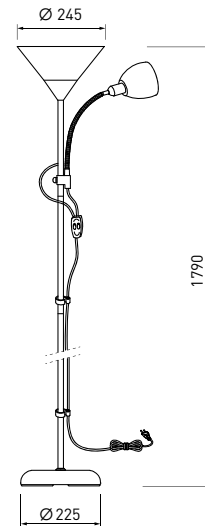

LP-BENFICA2-10	E27 - max 60 W E14 - max 40 W	tworzywo + metal, plastic + metal, пластик + металл, пластик + метал	czarny, black, черный, чорний	3000 g	5902801297809
LP-BENFICA2-80			szary, grey, серый, сірий		5908231398123
LP-BENFICA2-00			biały, white, белый, білий		5902801298233



VENETO

NEW



White

Black

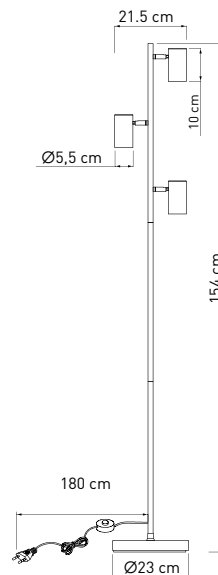

Decorative fixtures



LP-VEN20WO-00	3 x max 20 W	tworzywo + metal, plastic + metal, пластик + металл, пластик + метал	biały, white, белый, білий	5902801442971
LP-VEN20W-10			czarny, black, черный, чорний	5902801403491







SYSTEMY SZYNOWE
TRACK SYSTEMS
ТРЕКОВЫЕ СИСТЕМЫ ОСВЕЩЕНИЯ
ТРЕКОВІ СИСТЕМИ ОСВІТЛЕННЯ



Systemy szynowe 1 fazowe	
1-phase rail systems	
1-фазовые трековые системы	
1-фазові трекові системи	317

Reflektory LED	
Spot lights LED	
Трековые светильники	
Трекові світильники	318

Aksesoria	
Accessories	
Аксессуары	
Аksesуари	322

Szynoprzewody	
Track systems	
Шинопровод	
Шинопрвід.....	322

Systemy szynowe 3 fazowe	
3-phase rail systems	
3-фазовые трековые системы	
3-фазові трекові системи.....	325

Reflektory LED	
Spot lights LED	
Трековые светильники	
Трекові світильники	326

Szynoprzewody	
Track systems	
Шинопровод	
Шинопрвід.....	338

Aksesoria	
Accessories	
Аксессуары	
Аksesуари	345



SYSTEMY SZYNOWE 1 FAZOWE
1-PHASE RAIL SYSTEMS
1-ФАЗОВЫЕ ТРЕКОВЫЕ СИСТЕМЫ
1-ФАЗОВІ ТРЕКОВІ СИСТЕМИ

PL Reflektor do szynoprzewodu 1-fazowego
EN Track light for 1-phase rail
RU Светильник трековый 1-фазовый
UK Світильник трековий 1-фазовий

ORIO



White

Black

XLT-ORI-GU10-00	max 20 W	czarny, black, черный, чорний	алюміній	230 g	5902801391217
XLT-ORI-GU10-10		biały, white, белый, білий			5902801391231



PL Zestaw opraw
EN Fixture kit
RU Комплект светильников
UK Набір світильників

TRAX BIS



White

Black

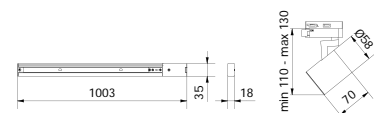

XLT-Z3OP20SZ1B-10	max 20 W	czarny, black, черный, чорний	алюміній	1280 g	5902801345340
XLT-Z3OP20SZ1B-00		biały, white, белый, білий			5902801345357



PL Reflektor do szynoprzewodu 1-fazowego
 EN Track light for 1-phase rail
 RU Светильник трековый 1-фазовый
 UK Світильник трековий 1-фазовий

ADO



White

Black

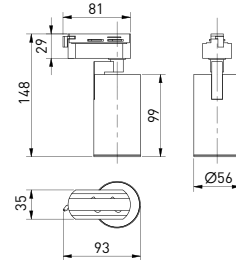

XLT-ADOGU10-00	max 20 W	biały, white, белый, білий	алюміній	230 g	5902801336508
XLT-ADOGU10-10		czarny, black, черный, чорний			5902801336348



PL Reflektor do szynoprzewodu 1-fazowego
 EN Track light for 1-phase rail
 RU Светильник трековый 1-фазовый
 UK Світильник трековий 1-фазовий

ETNA



White

Black

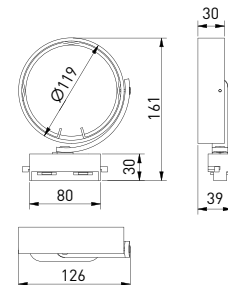

XLT-ETNAES111-00	max 20 W	biały, white, белый, білий	алюміній	230 g	5902801336409
XLT-ETNAES111-10		czarny, black, черный, чорний			5902801336577



PL Reflektor do szynoprzewodu 1-fazowego

EN Track light for 1-phase rail

RU Светильник трековый 1-фазовый

UK Світильник трековий 1-фазовий

LIMA

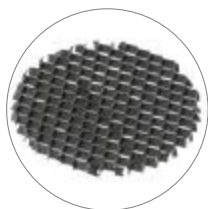

White

Black

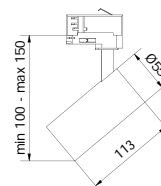

XLT-LMAGU10KB-NB	max 20 W	biały, white, белый, білий	алюміній	290 g	5902801383144
XLT-LMAGU10KC-NB		czarny, black, черный, чорний			5902801383182



PL Reflektor do szynoprzewodu 1-fazowego

EN Track light for 1-phase rail

RU Светильник трековый 1-фазовый

UK Світильник трековий 1-фазовий

LIMA

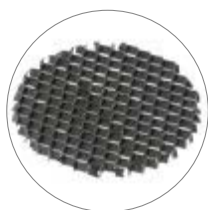

White

Black

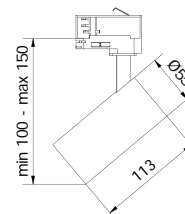

XLT-LMAGU10OB-NB	max 20 W	biały, white, белый, білий	алюміній	230 g	5902801382765
XLT-LMAGU10OC-NB		czarny, black, черный, чорний			5902801383106



PL Reflektor do szynoprzewodu 1-fazowego
EN Track light for 1-phase rail
RU Светильник трековый 1-фазовый
UK Світильник трековий 1-фазовий

GROSSO



White

Black

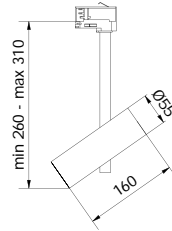

XLT-GRSGU10KB-NB	max 20 W	biały, white, белый, білий	алюміній	380 g	5902801383212
XLT-GRSGU10KC-NB		czarny, black, черный, чорний			5902801383236

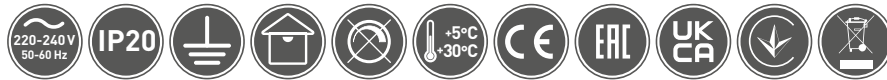

PL Reflektor do szynoprzewodu 1-fazowego
EN Track light for 1-phase rail
RU Светильник трековый 1-фазовый
UK Світильник трековий 1-фазовий

GROSSO

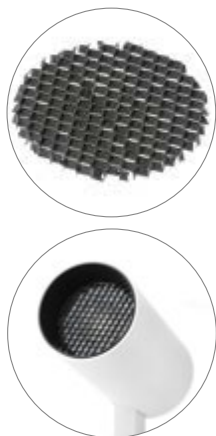

White

Black

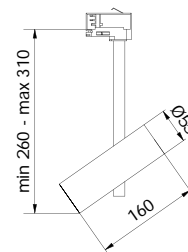

XLT-GRSGU100B-NB	max 20 W	biały, white, белый, білий	алюміній	450 g	5902801383274
XLT-GRSGU100C-NB		czarny, black, черный, чорний			5902801383298



PL Szynoprzewód 1-fazowy
EN 1-phase track
RU 1-фазовый шинопровод
UK 1-фазовий шинопровід



XLT-1FAC67-10	2 m	biały, white, белый, білий	алюміній	700 g	5902801320323
XLT-1FAC21A-10	1 m			350 g	5902801320842
XLT-1FAC66-00	2 m	czarny, black, черный, чорний		700 g	5902801320569
XLT-1FAC13A-00	1 m			350 g	5902801320828



XLT-1FAC24A-10



XLT-1FAC34-10



XLT-1FAC79-10



XLT-1FAC69-10



XLT-1FAC71-10

XLT-1FAC24A-10	40 g	5902801321498
XLT-1FAC34-10	60 g	5902801321511
XLT-1FAC79-10	60 g	5902801321344
XLT-1FAC69-10	60 g	5902801321337
XLT-1FAC71-10	40 g	5902801321399
XLT-1FAC19-00	40 g	5902801321597
XLT-1FAC33-00	60 g	5902801321481
XLT-1FAC78-00	60 g	5902801321504
XLT-1FAC68-00	60 g	5902801321405
XLT-1FAC70-00	40 g	5902801321375







SYSTEMY SZYNOWE 3 FAZOWE
3-PHASE RAIL SYSTEMS
3-ФАЗОВЫЕ ТРЕКОВЫЕ СИСТЕМЫ
3-ФАЗОВІ ТРЕКОВІ СИСТЕМИ

PL Reflektor do szynoprzewodu 3-fazowego
 EN Track light for 3-phase rail
 RU Светильник трековый 3-фазовый
 UK Світильник трековий 3-фазовий

LIMA



White

Black

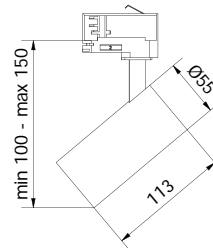

XLD-LMAGU10OB-NB	max 20 W	biały, white, белый, білий	алюміній	230 g	5902801322280
XLD-LMAGU10OC-NB		czarny, black, черный, чорний			5902801322419

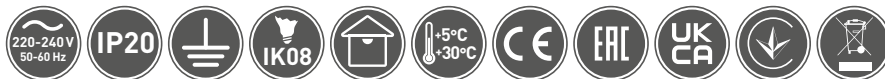

PL Reflektor do szynoprzewodu 3-fazowego
 EN Track light for 3-phase rail
 RU Светильник трековый 3-фазовый
 UK Світильник трековий 3-фазовий

LIMA



White

Black

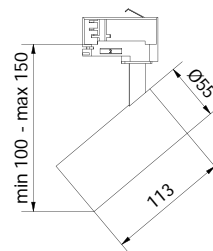

XLD-LMAGU10KB-NB	max 20 W	biały, white, белый, білий	алюміній	340 g	5902801322501
XLD-LMAGU10KC-NB		czarny, black, черный, чорний			5902801322150

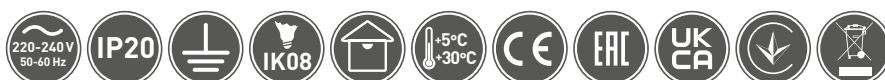



PL Reflektor do szynoprzewodu 3-fazowego
 EN Track light for 3-phase rail
 RU Светильник трековый 3-фазовый
 UK Світильник трековий 3-фазовий

GROSSO



White

Black

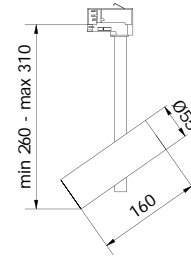

XLD-GRSGU10OB-NB	max 20 W	biały, white, белый, білий	алюміній	430 g	5902801356469
XLD-GRSGU10OC-NB		czarny, black, черный, чорний			5902801356520

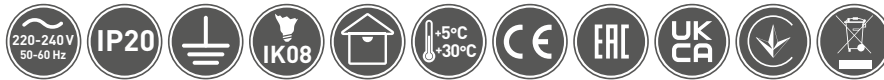

PL Reflektor do szynoprzewodu 3-fazowego
 EN Track light for 3-phase rail
 RU Светильник трековый 3-фазовый
 UK Світильник трековий 3-фазовий

GROSSO



White

Black

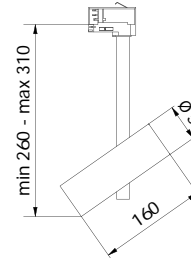

XLD-GRSGU10KB-NB	max 20 W	biały, white, белый, білий	алюміній	430 g	5902801356452
XLD-GRSGU10KC-NB		czarny, black, черный, чорний			5902801356483





PL Końcówka do oprawy na szynoprzewód LIMA i GROSSO
 EN Luminaire cap for LIMA and GROSSO busbars
 RU Заглушка для светильника на шинопроводе LIMA и GROSSO
 UK Торцева заглушка для світильника на шинопроводі LIMA і GROSSO



XLD-LKSWLGAB-00



XLD-LKSWLGBB-00



XLD-LKSWLGCB-00



XLD-LKSWLGAC-00



XLD-LKSWLGBC-00



XLD-LKSWLGCC-00

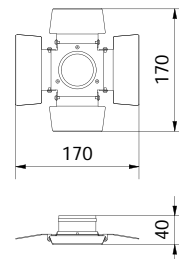
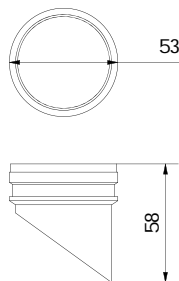
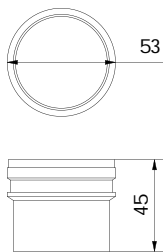

XLD-LKSWLGAB-00	biały, white, белый, білий	алюміній	100 g	5902801357732
XLD-LKSWLGAC-00	czarny, black, черный, чорний			5902801357800
XLD-LKSWLGBB-00	biały, white, белый, білий			5902801357794
XLD-LKSWLGBC-00	czarny, black, черный, чорний			5902801357831
XLD-LKSWLGCB-00	biały, white, белый, білий			5902801357848
XLD-LKSWLGCC-00	czarny, black, черный, чорний			5902801357879



PL Reflektor do szynoprzewodu 3-fazowego
 EN Track light for 3-phase rail
 RU Светильник трековый 3-фазовый
 UK Світильник трековий 3-фазовий

inside
8 W

SIERRA



White
 Black

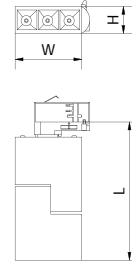

5
years
warranty
3
PHASE



LxWxH
mm



XLD-SRA08WB-NB	8 W	biały, white, белый, білий	алюміній	174 x 84 x 34	480 g	5902801357473
XLD-SRA08WC-NB		czarny, black, черный, чорний				5902801357558



PL Reflektor do szynoprzewodu 3-fazowego
 EN Track light for 3-phase rail
 RU Светильник трековый 3-фазовый
 UK Світильник трековий 3-фазовий

LED
inside
18 W

SIERRA



White
 Black

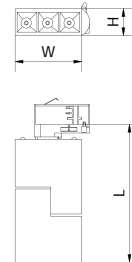

5
years
warranty
3
PHASE



LxWxH
mm



XLD-SRA18WB-NB	18 W	biały, white, белый, білий	алюміній	177 x 163 x 34	840 g	5902801357596
XLD-SRA18WC-NB		czarny, black, черный, чорний				5902801357619





PL Reflektor do szynoprzewodu 3-fazowego
 EN Track light for 3-phase rail
 RU Светильник трековый 3-фазовый
 UK Світильник трековий 3-фазовий

SIERRA



White

Black

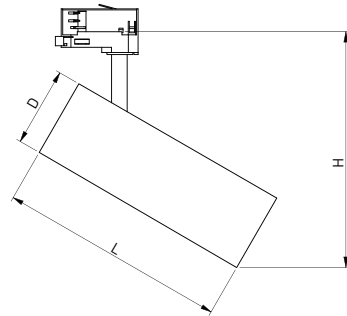

	L	D	H min	H max
TLD-12W38LN-NB0	155	ø55	130	210
TLD-12W38LN-NB1				
TLD-20W38LN-NB0	185	ø66	145	230
TLD-20W38LN-NB1				
TLD-30W38LN-NB0	220	ø77	153	270
TLD-30W38LN-NB1				



TLD-12W38LN-NB0	12 W	● 4000 K	PF>0,5	1100 lm	biały, white, белый, білий	алюміній	38°	370 g	5902801278563
TLD-12W38LN-NB1					czarny, black, черный, чорний				5902801278570
TLD-20W38LN-NB0	20 W		PF>0,9	1800 lm	biały, white, белый, білий			560 g	5902801278495
TLD-20W38LN-NB1					czarny, black, черный, чорний				5902801278631
TLD-30W38LN-NB0	30 W		2700 lm	biały, white, белый, білий	710 g			5902801278594	
TLD-30W38LN-NB1				czarny, black, черный, чорний				5902801278617	





35

30°

25°

20°

15°

PL Reflektor LED X-Line 3-fazowego
 EN X-Line LED track light fixture
 RU Светодиодный трековый светильник X-Line
 UK Світлодіодний трековий світильник X-Line



White

Black

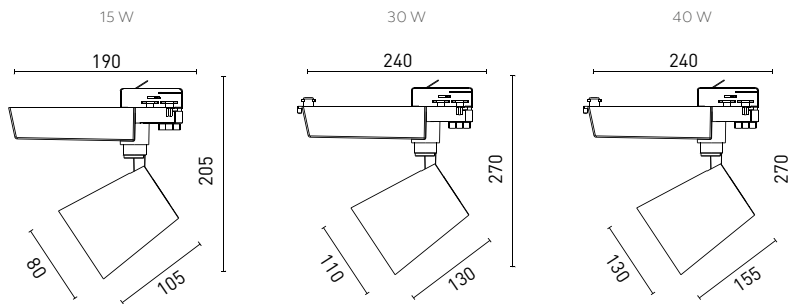

XLD-1524XLN-NB0	15 W	● 4000 K	1090 lm	biały, white, белый, білий	24°	0,6 kg	5901867199829
XLD-1560XLN-NB0					60°		5901867199843
XLD-3024XLN-NB0	30 W	● 4000 K	2050 lm	czarny, black, черный, чорний	24°	1,2 kg	5901867199881
XLD-3024XLN-NB1					60°		5902801000089
XLD-3060XLN-NB1					60°		5902801000102
XLD-3060XLN-NB0	40 W	● 4000 K	3240 lm	biały, white, белый, білий	60°	1,5 kg	5901867199904
XLD-4024XLN-NB0					24°		5901867199942
XLD-4060XLN-NB0					60°		5901867199966







SZYNOPRZEWODY
TRACK SYSTEMS
ШИНОПРОВОД
ШИНОПРОВІД

PL Szynoprzewód 3-fazowy
EN 3-circuit track
RU Шинопровод 3-фазовый
UK Шинопровід 3-фазовий

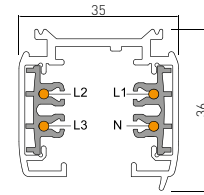

XTR-RA3FZ1B-00	biały, white, белый, білий	1 m	5901867193131
XTR-RA3FZ1C-10	czarny, black, черный, чорний	1 m	5901867193155
XTR-RA3FZ2B-00	biały, white, белый, білий	2 m	5901867193162
XTR-RA3FZ2C-10	czarny, black, черный, чорний	2 m	5901867193179



PL Końcówka zasilająca
EN End cap power connector
RU Наконечник подвода питания
UK Кінцівка з можливістю живлення

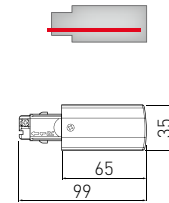

XAE-KZASPB-00	biały, white, белый, білий	5901867193339
XAE-KZASPC-10	czarny, black, черный, чорний	5901867193322



PL Końcówka zasilająca
EN End cap power connector
RU Наконечник подвода питания
UK Кінцівка з можливістю живлення

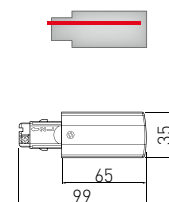

XAE-KZASLB-00	biały, white, белый, білий	5901867193308
XAE-KZASLC-10	czarny, black, черный, чорний	5901867193315



PL Łącznik „L” regulowany
 EN "L"-shape power connector
 RU Соединитель угловой 90°
 UK З'єднувач кутовий 90° регульований

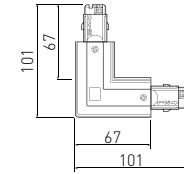
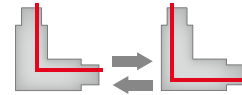
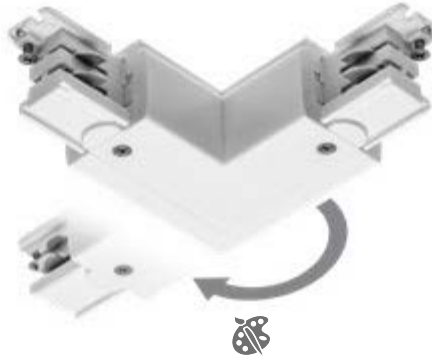

XAE-LKLRZWB-00	biały, white, белый, білий	5901867193544
XAE-LKLRZWC-10	czarny, black, черный, чорний	5901867193551



PL Łącznik „L”
 EN "L"-shape power connector
 RU Соединитель угловой 90°
 UK З'єднувач кутовий 90° з можливістю живлення

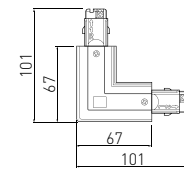
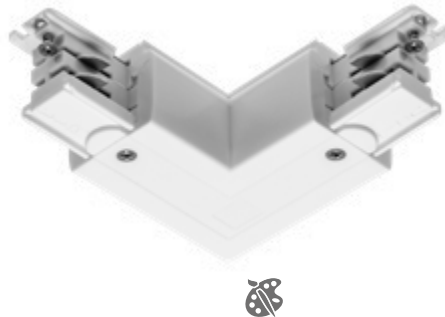

XAE-LKLLZB-00	biały, white, белый, білий	5901867193421
XAE-LKLLZC-10	czarny, black, черный, чорний	5901867193438



PL Łącznik „L”
 EN "L"-shape power connector
 RU Соединитель угловой 90°
 UK З'єднувач кутовий 90° з можливістю живлення

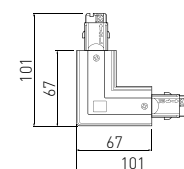
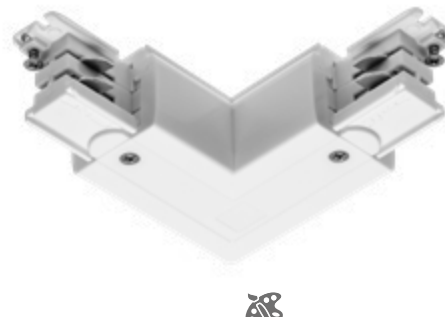

XAE-LKLPWB-00	biały, white, белый, білий	5901867193407
XAE-LKLPWC-10	czarny, black, черный, чорний	5901867193414



- PL Zakończenie szynoprzewodu
- EN End cap
- RU Заглушка шинпровода
- UK Заглушка шинпровода

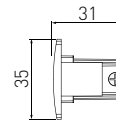

XAE-ZKUNCB-00	biały, white, белый, білий	5901867193346
XAE-ZKUNCC-10	czarny, black, черный, чорний	5901867193353

- PL Łącznik prosty
- EN Power connector
- RU Соединитель электрический
- UK З'єднувач електричний

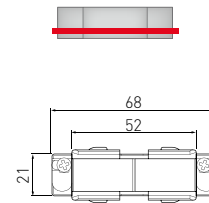

XAE-LKELB-00	biały, white, белый, білий	5901867193360
XAE-LKELC-10	czarny, black, черный, чорний	5901867193377



- PL Łącznik „X”
- EN "X"-shape power connector
- RU Соединитель угловой „X”
- UK З'єднувач кутовий "X"
з можливістю живлення

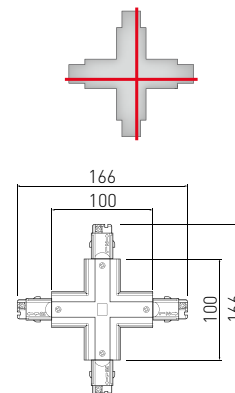
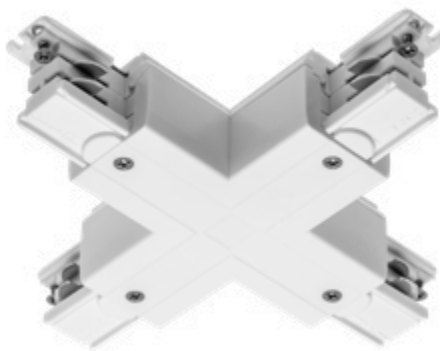

XAE-LKXUB-00	biały, white, белый, білий	5901867193445
XAE-LKXUC-10	czarny, black, черный, чорний	5901867193452



PL Łącznik „T” regulowany
EN "T"-shape power connector
RU Соединитель угловой „Т”
UK З'єднувач кутовий "Т"
регульований

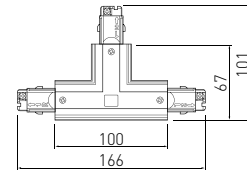
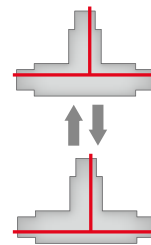

XAE-LKTRZWLБ-00	biały, white, белый, білий	5901867193582
XAE-LKTRZWLC-10	czarny, black, черный, чорний	5901867193599



PL Łącznik „T”
EN "T"-shape power connector
RU Соединитель угловой „Т”
UK З'єднувач кутовий "Т"
з можливістю живлення

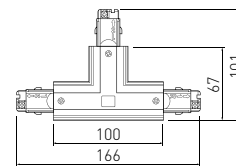
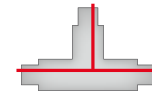
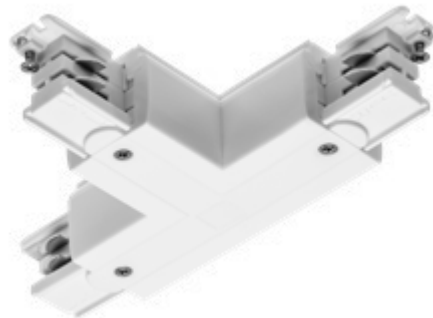

XAE-LKTWLB-00	biały, white, белый, білий	5902801001307
XAE-LKTWLC-10	czarny, black, черный, чорний	5902801001314



PL Łącznik „T”
EN "T"-shape power connector
RU Соединитель угловой „Т”
UK З'єднувач кутовий "Т"
з можливістю живлення

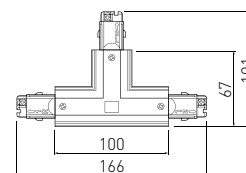
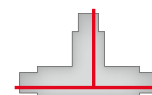
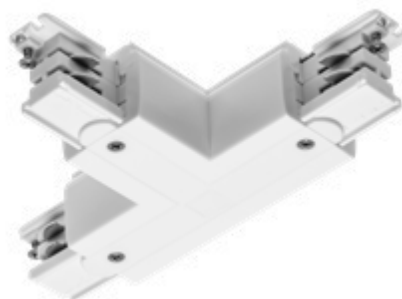

XAE-LKTZLB-00	biały, white, белый, білий	5901867193483
XAE-LKTZLC-10	czarny, black, черный, чорний	5901867193490



PL Łącznik „T” regulowany
 EN "T"-shape power connector
 RU Соединитель угловой „Т”
 UK З'єднувач кутовий "Т" регульований

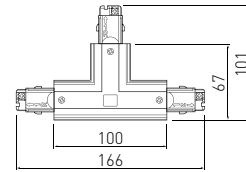
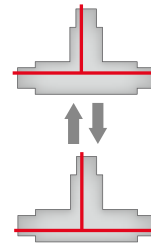
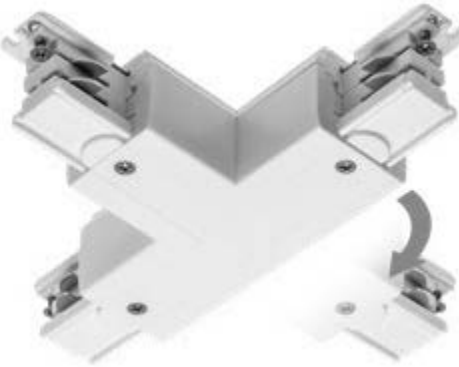

XAE-LKTRZWPB-00	biały, white, белый, білий	5901867193568
XAE-LKTRZWPC-10	czarny, black, черный, чорний	5901867193575



PL Łącznik „T”
 EN "T"-shape power connector
 RU Соединитель угловой „Т”
 UK З'єднувач кутовий "Т"
 з можливістю живлення

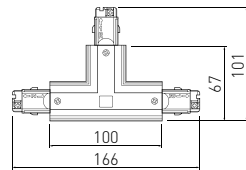
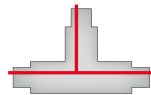
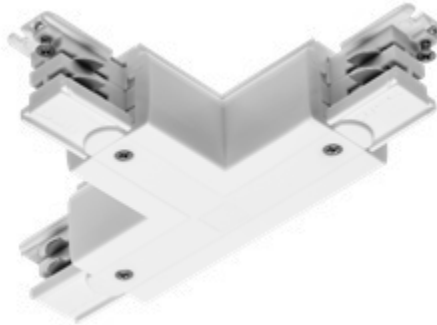

XAE-LKTWPB-00	biały, white, белый, білий	5902801001284
XAE-LKTWPC-10	czarny, black, черный, чорний	5902801001291



PL Łącznik „T”
 EN "T"-shape power connector
 RU Соединитель угловой „Т”
 UK З'єднувач кутовий "Т"
 з можливістю живлення

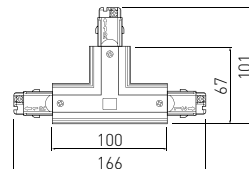
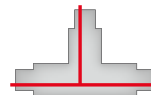
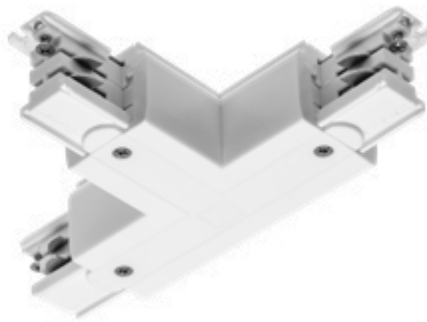

XAE-LKTZPB-00	biały, white, белый, білий	5901867193469
XAE-LKTZPC-10	czarny, black, черный, чорний	5901867193476



PL Łącznik prosty
EN Power connector
RU Соединитель электрический
UK З'єднувач електричний
з можливістю живлення

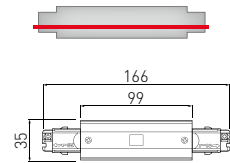

XAE-LELZB-00	biały, white, белый, білий	5901867193384
XAE-LELZC-10	czarny, black, черный, чорний	5901867193391



PL Łącznik regulowany
EN Adjustable power connector
RU Соединитель регулируемый
UK З'єднувач електричний регульований

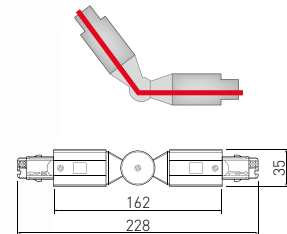

XAE-LKRUB-00	biały, white, белый, білий	5901867193520
XAE-LKRUC-10	czarny, black, черный, чорний	5901867193537



PL Łącznik elastyczny
EN Flexible power connector
RU Соединитель гибкий
UK З'єднувач електричний гнучкий

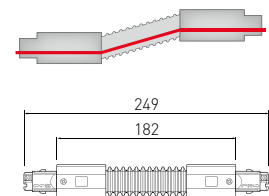
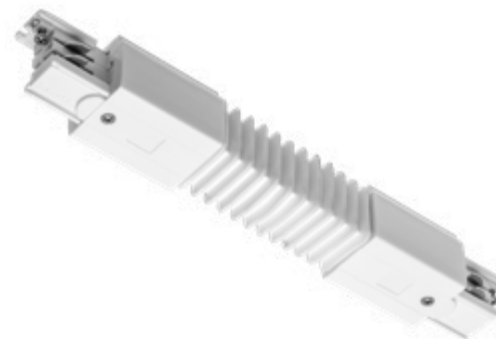

XAE-LELUB-00	biały, white, белый, білий	5901867193506
XAE-LELUC-10	czarny, black, черный, чорний	5901867193513



PL Mocowanie sufitowe
EN Suspension kit
RU Потолочное крепление
UK Стельове кріплення



XAE-MSUNB-00	biały, white, белый, білий	5901867193766
XAE-MSUNC-10	czarny, black, черный, чорний	5901867193773

PL Zestaw mocowanie sufitowe E-Z Click z linką
EN Ceiling mount suspension kit with wire
RU Крепление потолочное E-Z Click
UK Набір стельових кріплень E-Z Click

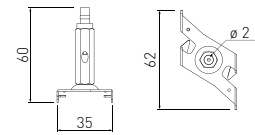
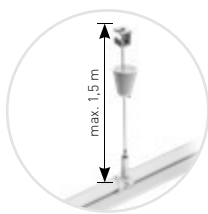

XAE-ZZWECLB-00	biały, white, белый, білий	5901867193605
XAE-ZZWECLC-10	czarny, black, черный, чорний	5901867193612

PL Zestaw mocowanie sufitowe 120 mm z linką
EN Ceiling mount suspension kit with wire
RU Крепление потолочное усиленное
UK Посиліне стельове кріплення

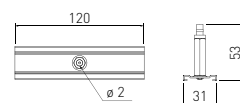
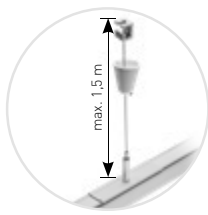

XAE-ZZWL120B-00	biały, white, белый, білий	5901867193667
XAE-ZZWL120C-10	czarny, black, черный, чорний	5901867193674



PL Łącznik mechaniczny 182 mm
EN Suspension clamp for track connection
RU Соединитель механический 182 мм
UK З'єднувач механічний 182 мм



XAE-LMIZB-00	biały, white, белый, білий	5901867193742
XAE-LMIZC-10	czarny, black, черный, чорний	5901867193759

PL Mocowanie sufitowe E-Z Click T25
EN E-Z Click T25 ceiling mounting kit
RU Крепление потолочное E-Z Click
UK Стельове кріплення E-Z Click T25



XAE-MSEZB-00	biały, white, белый, білий	5901867193629
XAE-MSEZC-10	czarny, black, черный, чорний	5901867193636

PL Mocowanie sufitowe 120 mm T25
EN Reinforced ceiling mounting kit
RU Крепление потолочное усиленное
UK Стельове кріплення посилене



XAE-MS120B-00	biały, white, белый, білий	5901867193704
XAE-MS120C-10	czarny, black, черный, чорний	5901867193711



- PL Baza do montażu natynkowego
- EN Fixed monopint track adapter
- RU База для поверхностного монтажа
- UK База для поверхневого монтажу

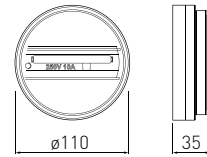

XAE-BNADB-00	biały, white, белый, білий	5901867193780
XAE-BNADC-10	czarny, black, черный, чорний	5901867193797

- PL Haczyk do zawieszenia
- EN Suspension hook
- RU Крючок для подвески
- UK Гачок для підвіски

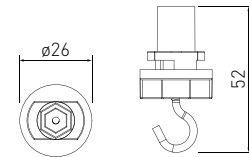

XAE-HMKB-00	biały, white, белый, білий	5901867193728
XAE-HMKC-10	czarny, black, черный, чорний	5901867193735

- PL Gniazdo SCHUKO
- EN SCHUKO outlet
- RU Розетка SCHUKO
- UK Розетка SCHUKO

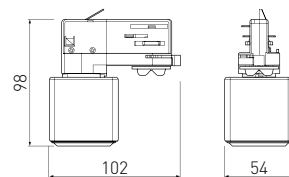

XAE-GNSCH-00	biały, white, белый, білий	5901867193803
--------------	----------------------------	---------------



Track systems



Zakończenie szynoprzewodu
End cap
Заглушка шинпровода
Заглушка шинпровода

Łącznik „X”
"X"-shape power connector
Соединитель угловой „X”
З'єднувач кутовий "X"
з можливістю живлення

Łącznik „T”
"T"-shape power connector
Соединитель угловой „T”
З'єднувач кутовий "T"
з можливістю живлення

Łącznik „L”
"L"-shape power connector
Соединитель угловой 90°
З'єднувач кутовий 90°
з можливістю живлення

Łącznik prosty
Power connector
Соединитель электрический
З'єднувач електричний



● Końcówka zasilająca
End cap power connector
Наконечник подвода питания
Кінцівка з можливістю живлення

● Łącznik prosty
Power connector
Соединитель электрический
З'єднувач електричний
з можливістю живлення

● Łącznik regulowany
"L"-shape adjustable connector
Соединитель регулируемый
З'єднувач електричний регульований



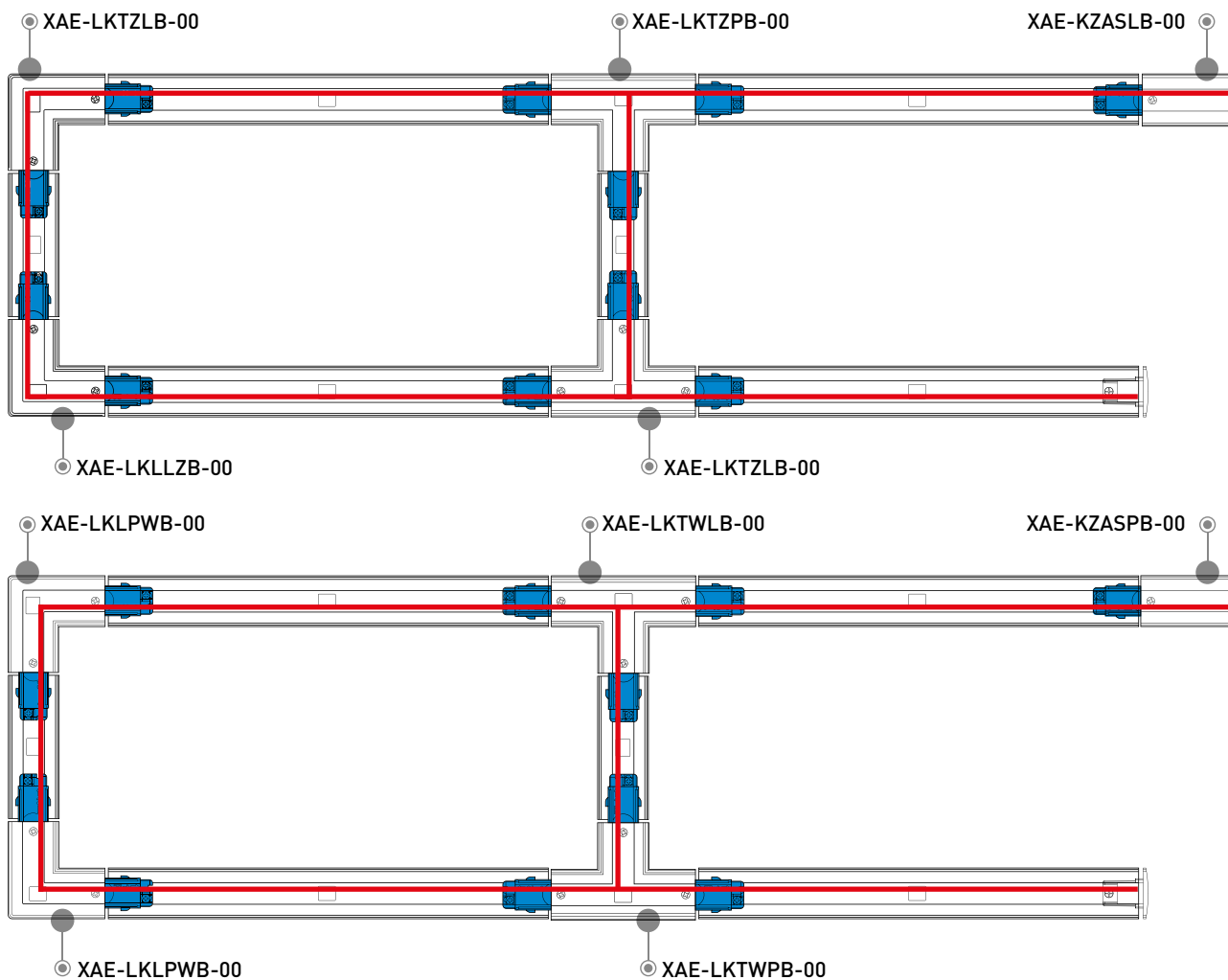

Szynoprzewód jest asymetryczny - przy doborze elementów należy zwrócić uwagę na ciągłość toru N.

Track is asymmetrical - while choosing the parts please make sure that the track N is continuous.

Шинопровод асимметричен - При выборе элементов, обратите внимание на непрерывность трека N.

Шинопрвід є асиметричним - при підборі елементів належить звернути увагу на неперервність треку N

Na rysunkach, tor N jest zaznaczony czerwoną linią.

The track N is marked with a red line on drawing.

На чертежах, трек N отмечен красной линией.

На схемі трек N позначений червоною лінією





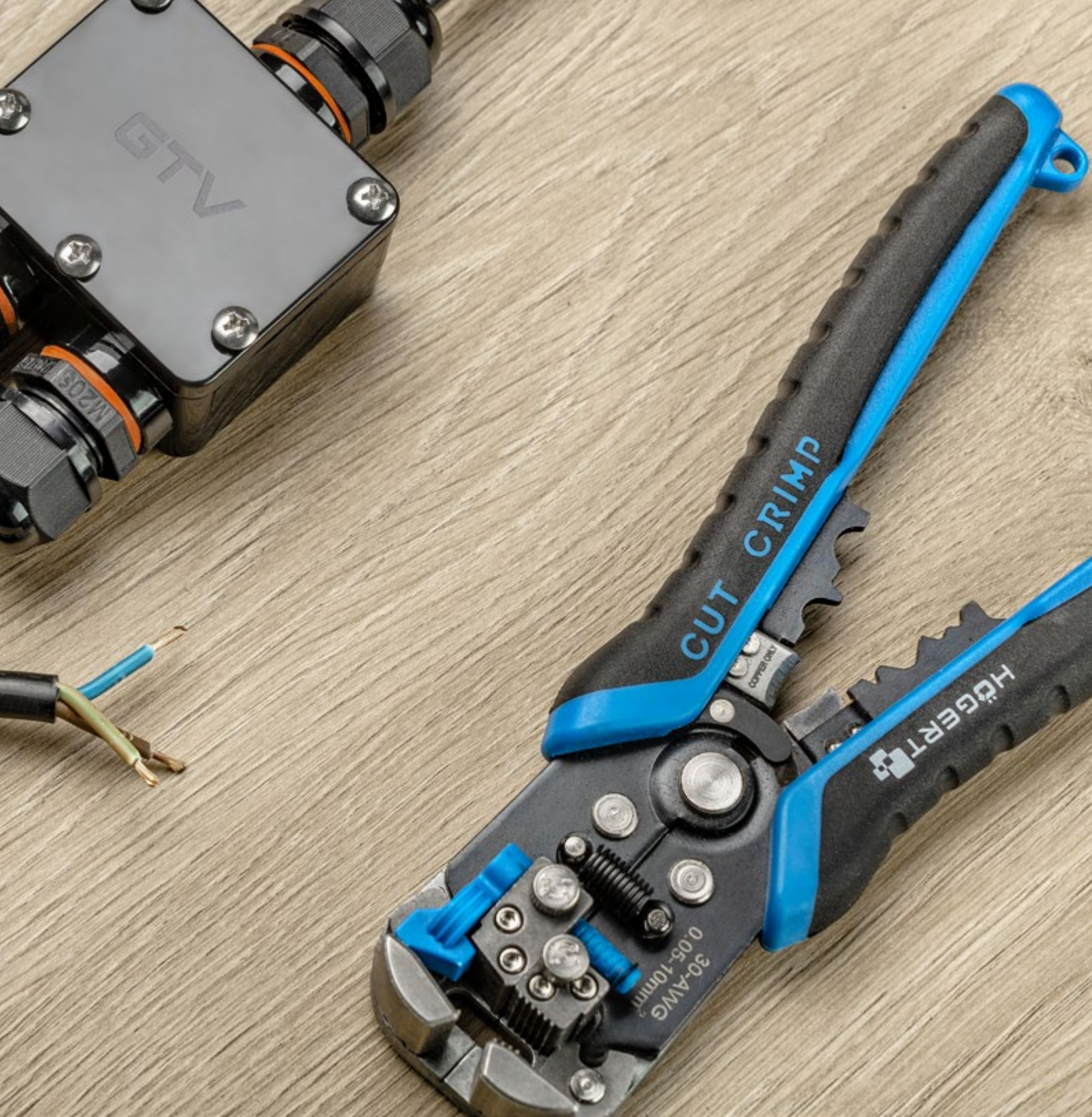

OSPRZĘT ELEKTROINSTALACYJNY
INSTALLATION FITTINGS
ЕЛЕКТРОУСТАНОВОЧНЫЕ ИЗДЕЛИЯ
ЕЛЕКТРОМОНТАЖНІ ВИРОБИ

Osprzęt elektroinstalacyjny	
Installation fittings	
Электроустановочные изделия	
Електромонтажні вироби	355





	CR-1	CR-2	CR-3	CR-3 Mini	CR-4LED
					
IP	IP-44	IP-44	IP-20	IP-20	IP-20
max obciążenie żarowe max. load (incandescent lamp) максимальная нагрузка лампками накаливания максимальне навантаження лампками розжарювання	1200W	1200W	1200W	2000W	1200W
max. obciążenie LED max. load (LED lamp) максимальная нагрузка светодиодными источниками света максимальне навантаження світлодіодними джерелами світла	300W	300W	300W	1000W	300W
ZASIĘG (sufit) RANGE (ceiling) ДИАПАЗОН (потолочный) ДАЛЬНОСТЬ (стельвий)	-	-			-
wys montażu mounting height высота монтажа висота монтажу	-	-	2,2-4 m	2,2-4 m	-
zasięg range диапазон дальність	-	-	6 m	6 m	-
ZASIĘG (ściana) RANGE (wall) ДИАПАЗОН (настенный) ДАЛЬНОСТЬ (настінний)			-	-	
wys montażu mounting height высота монтажа висота монтажу	1,8-2,5 m	1,8-2,5 m	-	-	1-1,8 m
zasięg range диапазон дальність	10 m	8 m	-	-	9 m
podłączenie (2-3-4 żyły) connection (2-3-4 wires) подключение (2-3-4 провода) підключення (2-3-4 дрони)	3	3	3	3	3
regulacja progu jasności brightness threshold adjustment регулювання порога яркості	3-2000 lx	3-2000 lx	3-2000 lx	3-2000 lx	3-2000 lx
regulacja czasu świecenia po zaniku ruchu adjustment of lighting time after loss of motion регулювання времени освітлення после исчезновения движения регулювання часу освітлення після зникнення руху	10 s ± 3 s/ 7min ± 2min	10 s ± 3 s/ 7min ± 2min	10 s ± 3 s/ 7min ± 2min	10 s ± 3 s/ 15min ± 2min	10 s ± 3 s / 7min ± 2min





CR-5	CR-5Mini	CR-6	CR-7	CR-8	CR-9
------	----------	------	------	------	------



IP-20	IP-20	IP-20	IP-20	IP-20	IP-65
1200W	800W	60W	800W	400W	1200W
300W	400W	60W	400W	200W	300W
			-		-
2,2-4 m	2,2-4 m	2-3,5 m	-	2,2-4 m	-
6 m	6 m	6 m	-	4+4 m	-
-	-	-		-	
-	-	-	1,8-2,5 m	-	2,5-3,5 m
-	-	-	6 m	-	2-8 m
3	3	E27	3	4	3
3-2000 lx	3-2000 lx	3-2000 lx	10/2000lx	3-2000 lx	3-2000 lx
10 s ± 3 s / 15min ± 2min	10 s ± 3 s / 15min ± 2min	10 s ± 3 s / 5min ± 1min	5s + 30s + 1min + 3min + 5min + 8min	10 s ± 3 s / 7min ± 2min	10 s ± 3 s / 7min ± 2min





	CR-9M	CR-11	CR-12	CR-13	CR-14
IP	IP-65	IP-44	IP-65	IP-44	IP-20
max obciążenie żarowe max. load (incandescent lamp) максимальная нагрузка лампами накаливания максимальне навантаження лампами розжарювання	1200W	1200W	2000W	800W	300W
max. obciążenie LED max. load (LED lamp) максимальная нагрузка светоди- одными источниками света максимальне навантаження світ- лодіодними джерелами світла	600W	300W	1000W	400W	150W
ZASIĘG (sufit) RANGE (ceiling) ДИАПАЗОН (потолочный) ДАЛЬНІСТЬ (стельовий)	-	-		-	-
wys montażu mounting height высота монтажа висота монтажу	-	-	2,2-4 m	-	-
zasięg range диапазон дальність	-	-	4+4 m	-	-
ZASIĘG (ściana) RANGE (wall) ДИАПАЗОН (настенный) ДАЛЬНІСТЬ (настінний)			-		
wys montażu mounting height высота монтажа висота монтажу	1,8-2,5 m	1,8-2,5 m	-	1,8-2,5 m	1,0-1,8 m
zasięg range диапазон дальність	-3 m / +12 m	12 m	-	12 m	9 m
podłączenie (2-3-4 żyły) connection (2-3-4 wires) подключение (2-3-4 провода) підключення (2-3-4 дроти)	3	3	4	3	2
regulacja progu jasności brightness threshold adjustment регулировка порога яркости регулювання порогу яскравості	3-2000 lx	3-2000 lx	3-2000 lx	3-2000 lx	3-2000 lx
regulacja czasu świecenia po zaniku ruchu adjustment of lighting time after loss of motion регулировка времени освещения после исчезновения движения регулювання часу освітлення після зникнення руху	10 s ± 3 s/ 15min ± 2min	10 s ± 3 s/ 7min ± 2min	10 s ± 3 s/ 30min ± 2min	10 s ± 3 s/ 15min ± 2min	10 s ± 3 s/ 7min ± 2min





CR-15	CR-16	CR-17	CR-18	CR-19	CO-1	CO-2
-------	-------	-------	-------	-------	------	------



IP-20	IP20	IP-65	IP-20	IP44	IP-20	IP-65
800W	500W	800W	500W	2000W	2000W	2000W
400W	200W	400W	200W	1000W	1000W	1000W
	-					
2,2-4 m	-	2,2-4 m	2,2-4 m	2,2-6 m	2,2-6 m	2,2-4 m
4+4 m	-	-2 m / + 10 m	3+3 m	10+10 m	10+10 m	motion 10+10 m, presence 3+3 m
-				-	-	-
-	1,0-1,8 m	1,8-2,5 m	1,8-2,5 m	-	-	-
-	4-9 m	-2 m / + 10 m	8 m	-	-	-
3	2	3	4	4	3	4
3-2000 lx	3-2000 lx	3-2000 lx	3-2000 lx	3-2000 lx	3-2000 lx	3-2000 lx
10 s ± 3 s/ 15min ± 2min	10 s ± 3 s/ 7min ± 2min	10 s ± 3 s/ 15min ± 2min	10 s ± 3 s/ 15min ± 30 s	10 s ± 3 s/ 30min ± 2min	10 s ± 3 s/ 30min ± 2min	10 s ± 3 s/ 30min ± 2min



PL Czujnik ruchu
EN Motion detector
RU Датчик движения
UK Датчик руху

CR-1



White

Black

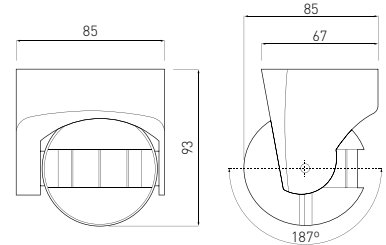

CR-CR1000-10	tworzywo, plastic, пластмасса, пластик	czarny, black, черный, чорний	160 g	5908231308184
CR-CR1000-00		biały, white, белый, білий		5908231308160



PL Czujnik ruchu
EN Motion detector
RU Датчик движения
UK Датчик руху

CR-2



White

Black

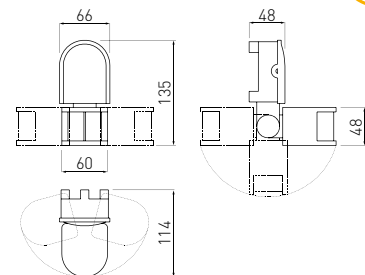

Installation fittings



CR-CR2000-10	tworzywo, plastic, пластмасса, пластик	czarny, black, черный, чорний	180 g	5908231308238
CR-CR2000-00		biały, white, белый, білий		5908231308207



PL Czujnik ruchu
EN Motion detector
RU Датчик движения
UK Датчик руху

CR-3



White

Black

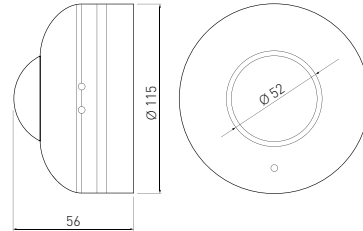

CR-CR3000-10	tworzywo, plastic, пластмасса, пластик	czarny, black, черный, чорний	170 g	5902801342172
CR-CR3000-00		biały, white, белый, білий		5908231308146



PL Czujnik ruchu
EN Motion detector
RU Датчик движения
UK Датчик руху

CR-3 MINI



White

Black

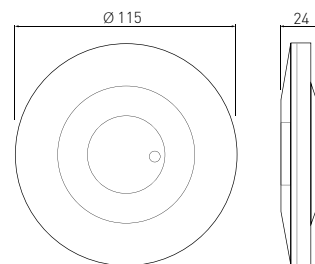

CR-CR3M00-10	tworzywo, plastic, пластмасса, пластик	czarny, black, черный, чорний	100 g	5902801342301
CR-CR3M00-00		biały, white, белый, білий		5901867146076



PL Czujnik ruchu
EN Motion detector
RU Датчик движения
UK Датчик руху

CR-4LED

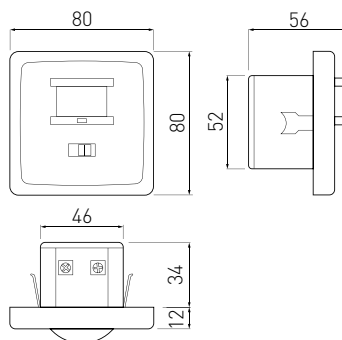

CR-CR4L00-00	tworzywo, plastic, пластмасса, пластик	biały, white, белый, білий	100 g	5908231308122
--------------	--	----------------------------	-------	---------------



PL Czujnik ruchu
EN Motion detector
RU Датчик движения
UK Датчик руху

CR-5

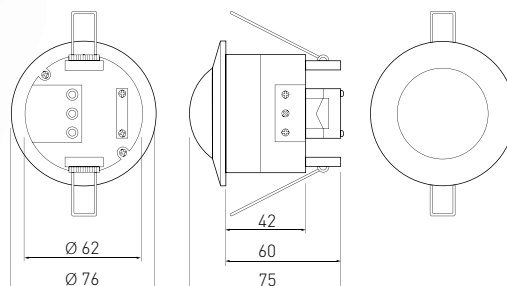

CR-CR5000-00	tworzywo, plastic, пластмасса, пластик	biały, white, белый, білий	100 g	5908231308115
--------------	--	----------------------------	-------	---------------



PL Czujnik ruchu wpuszczany
EN Recessed motion detector
RU Датчик движения скрытый
UK Вбудований датчик руху

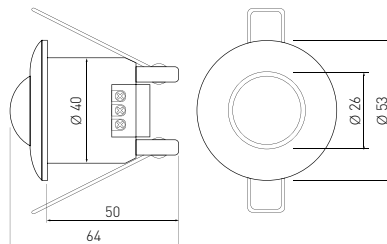
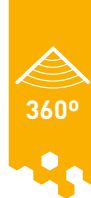

CR-CR5M00-00	tworzywo, plastic, пластмасса, пластик	biały, white, белый, білий	50 g	5901867108890
--------------	--	----------------------------	------	---------------



PL Czujnik ruchu na podczerwień
EN Infrared motion sensor
RU Датчик движения инфракрасный
UK Датчик руху

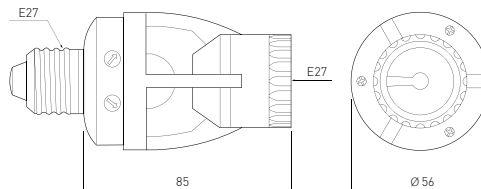
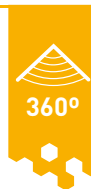

CR-CR6000-00	tworzywo, plastic, пластмасса, пластик	biały, white, белый, білий	80 g	5901867103437
--------------	--	----------------------------	------	---------------



Installation fittings



PL Czujnik ruchu z zewnętrznym sensorem na podczerwień
 EN Motion detector with external IR sensor
 RU Датчик движения с наружным сенсором инфракрасный
 UK Датчик руху із зовнішнім інфрачервоним сенсором

CR-7

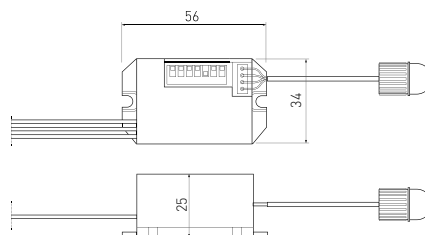

CR-CR7000-00	tworzywo, plastic, пластмасса, пластик	biały, white, белый, білий	170 g	5901867103444
--------------	--	----------------------------	-------	---------------



PL Czujnik ruchu
 EN Motion detector
 RU Датчик движения
 UK Датчик руху

CR-8

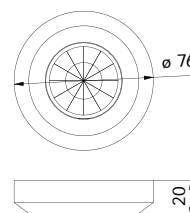

CR-CR8000-00	tworzywo, plastic, пластмасса, пластик	biały, white, белый, білий	50 g	5902801294969
--------------	--	----------------------------	------	---------------



PL Czujnik ruchu
EN Motion detector
RU Датчик движения
UK Датчик руху

CR-9



White

Black

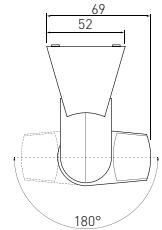
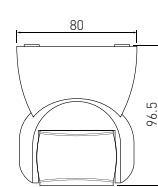

CR-CR9000-00	tworzywo, plastic, пластмасса, пластик	biały, white, белый, білий	5901867108906
CR-CR9000-10		czarny, black, черный, чорний	5901867138507



PL Czujnik ruchu
EN Motion detector
RU Датчик движения
UK Датчик руху

CR-9 mini



White

Black

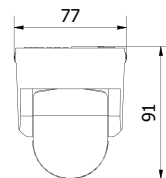

CR-CR9M00-00	PC	biały, white, белый, білий	120 g	5902801294433
CR-CR9M00-10		czarny, black, черный, чорний		5902801294518



PL Czujnik ruchu i obecności
EN Motion and presence sensor
RU Датчик движения и присутствия
UK Сенсор руху і присутності

CO-1

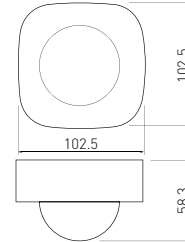

CR-CO1000-00	tworzywo, plastic, пластмасса, пластик	biały, white, белый, білий	140 g	5901867146090



PL Czujnik ruchu i obecności
EN Motion and presence sensor
RU Датчик движения и присутствия
UK Сенсор руху і присутності

CO-2

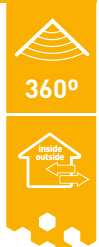
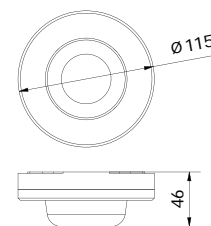

CR-CO2000-00	1000 W	2000 W	tworzywo, plastic, пластмасса, пластик	biały, white, белый, білий	150 g	5902801261534



Installation fittings

PL Czujnik ruchu
EN Motion and presence sensor
RU Датчик движения
UK Датчик руху

CR-11

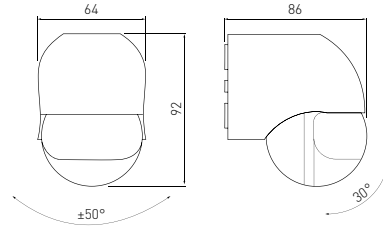
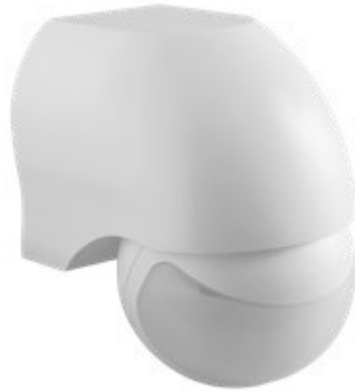

CR-CR1100-00	tworzywo, plastic, пластмасса, пластик	biały, white, белый, білий	160 g	5901867108913
--------------	--	----------------------------	-------	---------------



PL Czujnik ruchu
EN Motion detector
RU Датчик движения
UK Датчик руху

CR-12

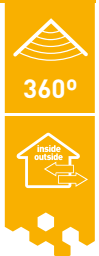
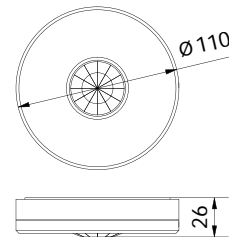

CR-CR1200-00	1000 W	2000 W	tworzywo, plastic, пластмасса, пластик	biały, white, белый, білий	130 g	5902801261664
--------------	--------	--------	--	----------------------------	-------	---------------



PL Czujnik ruchu
EN Motion detector
RU Датчик движения
UK Датчик руху

CR-13

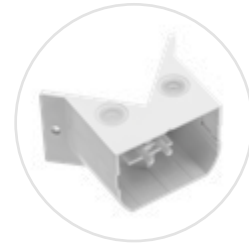

Montaż narożny,
Corner mounting,
Угловой монтаж,
Кутювий монтаж.

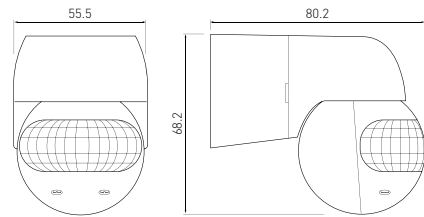

CR-CR13000-00	tworzywo, plastic, пластмасса, пластик	biały, white, белый, білий	120 g	5901867188274



PL Czujnik ruchu
EN Motion detector
RU Датчик движения
UK Датчик руху

CR-14

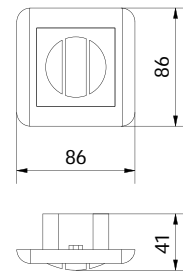

CR-CR1400-00	tworzywo, plastic, пластмасса, пластик	biały, white, белый, білий	82 g	5902801294174



PL Czujnik ruchu
EN Motion detector
RU Датчик движения
UK Датчик руху

CR-15

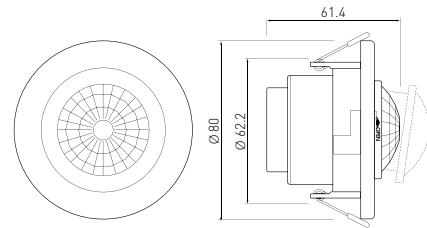

CR-CR15000-00	tworzywo, plastic, пластмасса, пластик	biały, white, белый, білий	90 g	5901867188212
---------------	--	----------------------------	------	---------------



PL Czujnik ruchu
EN Motion detector
RU Датчик движения
UK Датчик руху

CR-16

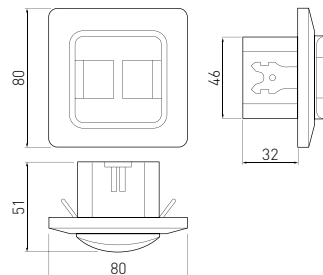

CR-CR16000-00	tworzywo, plastic, пластмасса, пластик	biały, white, белый, білий	88 g	5902801002533
---------------	--	----------------------------	------	---------------



PL Czujnik ruchu
EN Motion detector
RU Датчик движения
UK Датчик руху

CR-17

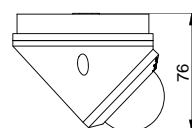
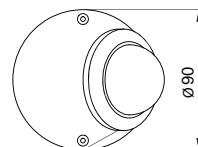

CR-CR17000-00	tworzywo, plastic, пластмасса, пластик	biały, white, белый, білий	55 g	5902801282102
---------------	--	----------------------------	------	---------------



PL Czujnik ruchu
EN Motion detector
RU Датчик движения
UK Датчик руху

CR-18

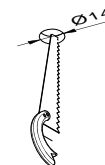
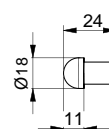
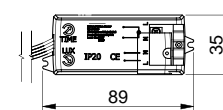
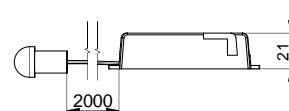

CR-CR18000-00	PC	biały, white, белый, білий	55 g	5902801282058
---------------	----	----------------------------	------	---------------



PL Czujnik ruchu i obecności
EN Motion and presence sensor
RU Датчик движения и присутствия
UK Сенсор руху і присутності

CR-19

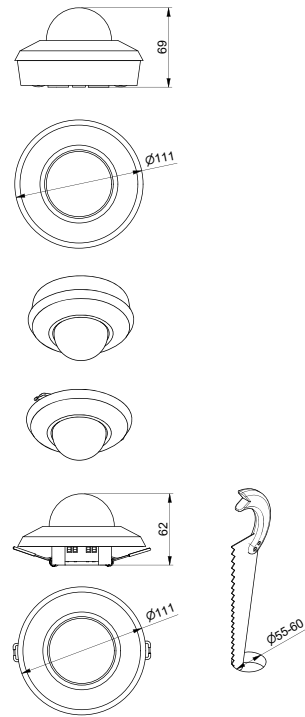

CR-CR19000-00

PC

biały, white, белый, білий

170 g

5902801282140



PL Czujnik ruchu mikrofalowy
EN Microwave motion sensor
RU Микроволновой датчик движения
UK Мікрохвильовий датчик руху

CM-1

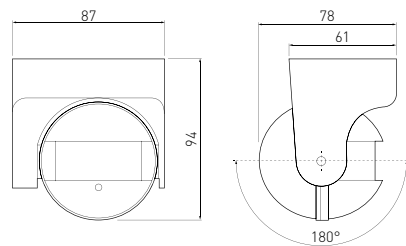

AE-CM1000-00

tworzywo, plastic, пластмасса, пластик

biały, white, белый, білий

160 g

5901867108876



PL Czujnik ruchu mikrofalowy
EN Microwave motion sensor
RU Микроволновой датчик движения
UK Мікрохвильовий датчик руху

CM-3

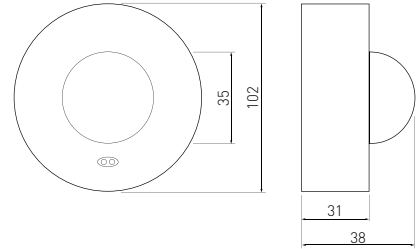

AE-CM3000-00	tworzywo, plastic, пластмасса, пластик	biały, white, белый, білий	170 g	5908231339997



PL Czujnik ruchu mikrofalowy
EN Microwave motion sensor
RU Микроволновой датчик движения
UK Мікрохвильовий датчик руху

CM-3 MINI



White

Black

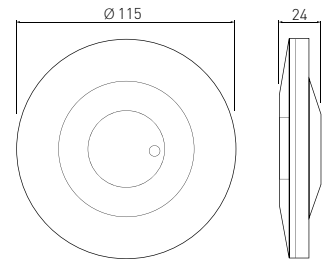

Installation fittings



AE-CM3M00-00	tworzywo, plastic, пластмасса, пластик	biały, white, белый, білий	110 g	5901867188250
AE-CM3M00-10				5902801458552



PL Czujnik ruchu mikrofalowy
 EN Microwave motion sensor
 RU Микроволновой датчик движения
 UK Мікрохвильовий датчик руху

CM-4

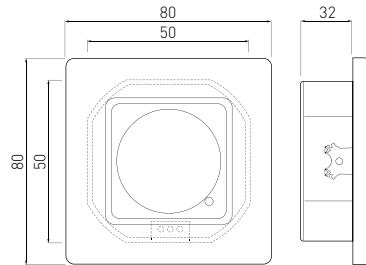

AE-CM4000-00	tworzywo, plastic, пластмасса, пластик	biały, white, белый, білий	90 g	5901867188236
--------------	--	----------------------------	------	---------------



PL Czujnik ruchu mikrofalowy
 EN Microwave motion sensor
 RU Микроволновой датчик движения
 UK Мікрохвильовий датчик руху

CM-5

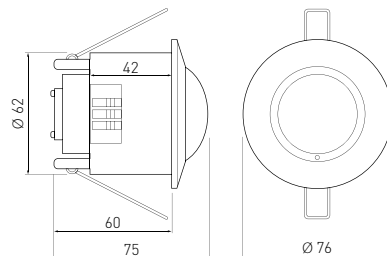

AE-CM5000-00	tworzywo, plastic, пластмасса, пластик	biały, white, белый, білий	100 g	5901867108883
--------------	--	----------------------------	-------	---------------



PL Czujnik ruchu mikrofalowy
 EN Microwave motion sensor
 RU Микроволновой датчик движения
 UK Мікрохвильовий датчик руху

CM-6

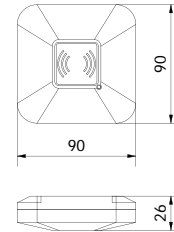

AE-CM6000-00	400 W	800 W	PC	biały, white, белый, білий	100 g	5902801285189
--------------	-------	-------	----	----------------------------	-------	---------------

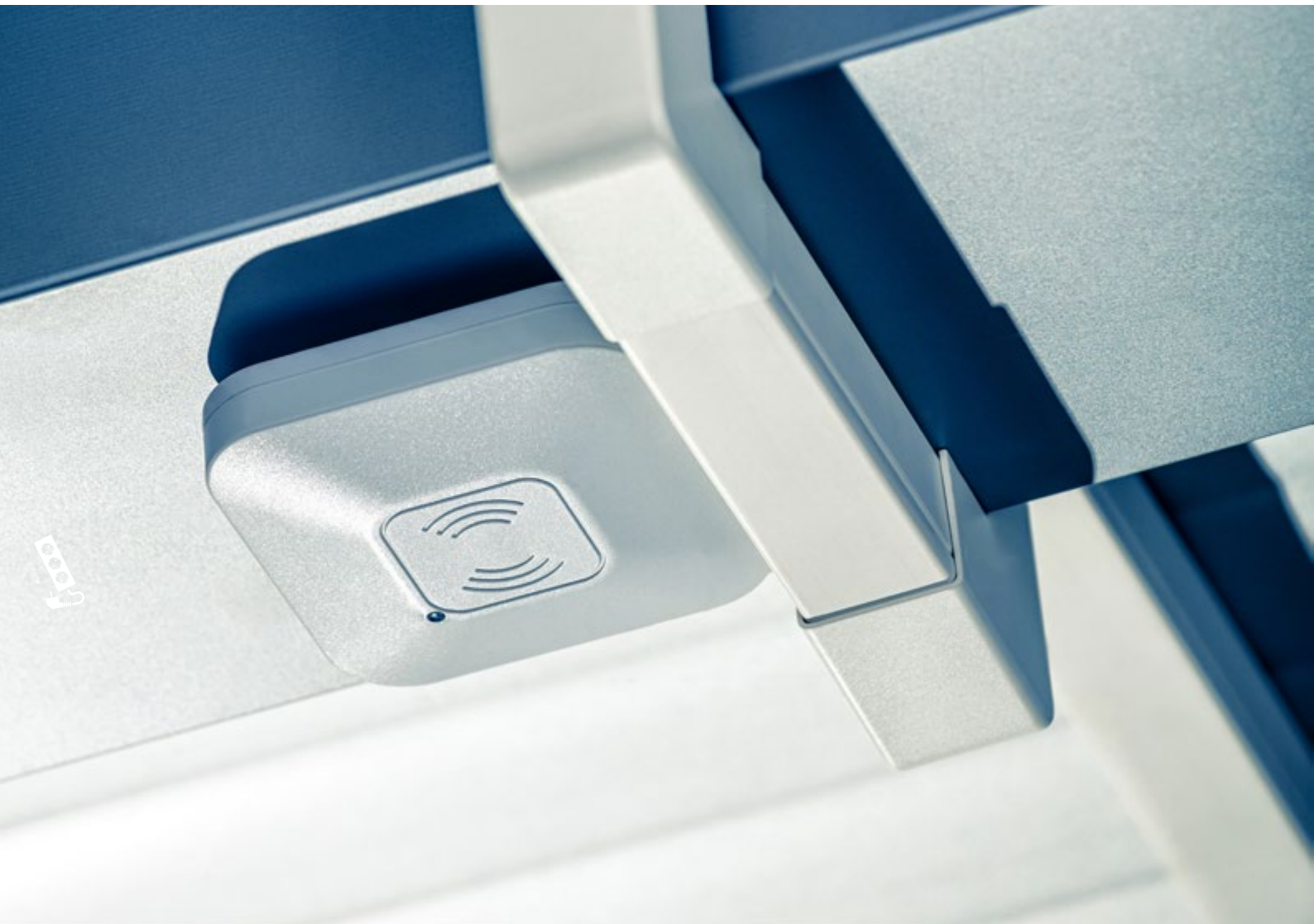

PL Czujnik ruchu mikrofalowy
EN Microwave motion sensor
RU Микроволновой датчик движения
UK Мікрохвильовий датчик руху

CM-9



White

Black

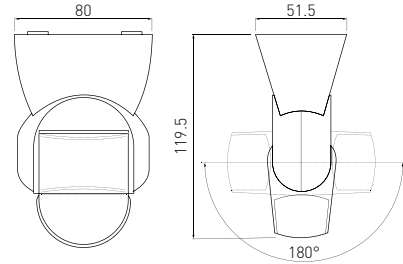

AE-CM9000-00	tworzywo, plastic, пластмасса, пластик	biały, white, белый, білий	161 g	5901867196972
AE-CM9000-10		czarny, black, черный, чорний		5901867196996



PL Czujnik ruchu mikrofalowy
EN Microwave motion sensor
RU Микроволновой датчик движения
UK Мікрохвильовий датчик руху

CM-15

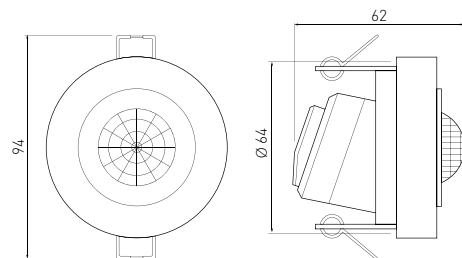

AE-CM1500-00	tworzywo, plastic, пластмасса, пластик	biały, white, белый, білий	103 g	5902801002519



Installation fittings



PL Czujnik ruchu mikrofalowy
EN Microwave motion sensor
RU Микроволновой датчик движения
UK Мікрохвильовий датчик руху

SRC812-MINI

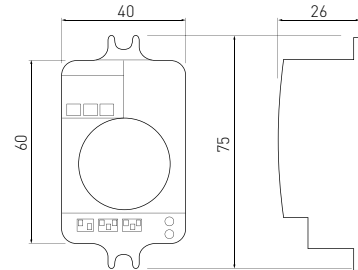

AE-SRC812-MIN	tworzywo, plastic, пластмасса, пластик	biały, white, белый, білий	45 g	5901867124326
---------------	--	----------------------------	------	---------------



PL Czujnik ruchu mikrofalowy
EN Microwave motion sensor
RU Микроволновой датчик движения
UK Мікрохвильовий датчик руху

SRC812-MINI2

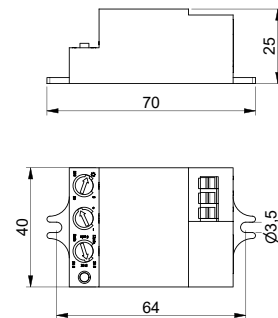

AE-SRC812-MIN2	PC	biały, white, белый, білий	40 g	5902801282133
----------------	----	----------------------------	------	---------------



PL Czujnik ruchu mikrofalowy
EN Microwave motion sensor
RU Микроволновой датчик движения
UK Мікрохвильовий датчик руху

SRC812

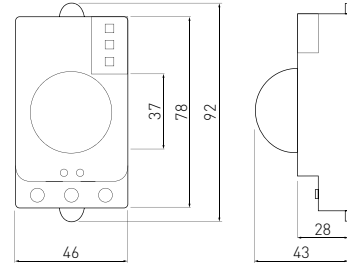

AE-SRC812-00	tworzywo, plastic, пластмасса, пластик	biały, white, белый, білий	70 g	5908231303738



PL Czujnik zmierzchowy
EN Twilight sensor
RU Датчик сумерек
UK Датчик сутінків

CZ-1

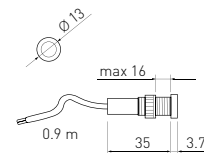
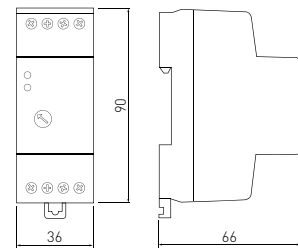

CZ-CZ1000-00	tworzywo, plastic, пластмасса, пластик	biały, white, белый, білий	130 g	5901867108920



Installation fittings

PL Czujnik zmierzchowy
 EN Twilight sensor
 RU Датчик сумерек
 UK Датчик сутінків

MAX
4800 W

5
years
warranty

CZ-2

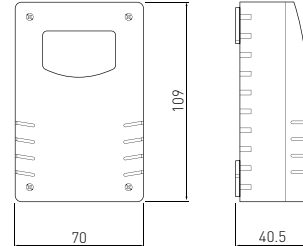

CZ-CZ2000-00	tworzywo, plastic, пластмасса, пластик	biały, white, белый, білий	130 g	5901867108937
--------------	--	----------------------------	-------	---------------



PL Programator czasowy mechaniczny 24 h
EN 24h programmable timer
RU Временной механический программатор 24 ч.
UK Механічний програматор часу 24 години



PC-MECH24-00

PC-MECH24-SC

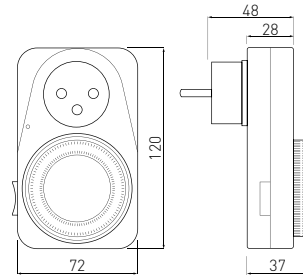

PC-MECH24-00	tworzywo, plastic, пластмасса, пластик	biały, white, белый, білий	140 g	5908231327215
PC-MECH24-SC				5908231351104



PL Programator czasowy elektroniczny 7 dniowy 24 h
EN 24 h, 7 day electronic programmable timer
RU Временной электронный программатор 24 часа, 7 дней
UK Електронний програматор на 7 днів 24 години

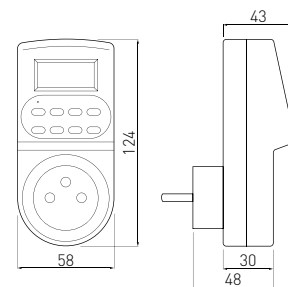

PC-ELE724-00	tworzywo, plastic, пластмасса, пластик	biały, white, белый, білий	150 g	5908231327208
PC-ELE724-SC				5908231351128



PL Przedłużacz domowy
EN Extension cord
RU Удлинитель для офиса
UK Домашній подовжувач



Folder	Length (m)	Number of outlets	Cable type	Barcode
AE-PS3G3M-00	3 m	3	H05VV-F 3x1.5 mm ²	5908231301192
AE-PS3G5M-00	5 m			5908231301208
AE-PS4G3M-00	3 m	4		5908231301215
AE-PS4G5M-00	5 m			5908231301222
AE-PS5G3M-00	3 m	5		5908231301239
AE-PS5G5M-00	5 m			5908231301246



PL Przedłużacz domowy
EN Extension cord
RU Удлинитель для офиса
UK Домашній подовжувач



Folder	Length (m)	Number of outlets	Cable type	Barcode
AE-PF3G1M-00	1,5 m	3	H05VV-F 3G1.0 mm ²	5901867170057
AE-PF3G3M-00	3 m			5901867170033
AE-PF3G5M-00	5 m			5901867170040
AE-PF5G3M-00	3 m	5		5901867170064
AE-PF5G5M-00	5 m			5901867170071



PL Przedłużacz bębnowy (schuko)
EN Extension cord reel (schuko socket)
RU Удлинитель барабанный (гнездо schuko)
UK Барабанный подовжувач (schuko)



AE-SBEBEN-30	30 m	4	3 x 1,5 mm ²	tworzywo + stal, plastic + steel, пластик + сталь, пластик + сталь	czarny, black, черный, чорний	5908231322722
AE-SBEBEN-50	50 m					5908231322739



PL Przedłużacz bębnowy z wyłącznikiem termicznym
EN Extension cord reel with a thermal switch
RU Удлинитель барабанный с тепловым выключателем
UK Барабанный подовжувач з термічним вимикачем



AE-PFBEBEN-20	20 m	4	3 x 1 mm ²	tworzywo + stal, plastic + steel, пластик + сталь, пластик + сталь	czarny, black, черный, чорний	5901867170088
AE-PFBEBEN-40	40 m					5901867170095



PL Przedłużacz ogrodowy
EN Garden extension cord
RU Удлинитель садовый
UK Садовий подовжувач

10 A

3 years warranty



AE-POGRODUN-10	10 m	2 x 1,0 mm ²	pomarańczowy, orange, оранжевый, помаранчевий	5901867163387
AE-POGRODUN-20	20 m			5901867163394
AE-POGRODUN-30	30 m			5901867163400



PL Gniazdo do lamp
EN Lamp base socket
RU Разъем для ламп
UK Гніздо для ламп



inside
GU10
MR16
5 years warranty

Installation fittings

GZ-GZ10-0000	biały, white, белый, білий	5908231305756
GZ-MR16-0000*		5908231331656



PL Gniazdo do lamp
EN Lamp base socket
RU Разъем для ламп
UK Гніздо для ламп

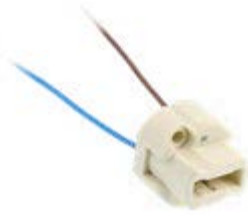

GZ-G90000-00

biały, white, белый, білий

5902801222665



PL Rozgałęziacz z uziemieniem
EN Outlet junction with PE
RU Разветвитель с заземлением FRENCH
UK Відгалужувач із заземленням FRENCH

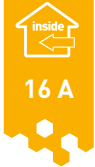

INFO



AE-RU0121-00

1 na 2 + 1, 2+1-way, 1 na 2 + 1, 1 na 2 + 1

5908231301260



PL Rozgałęziacz z uziemieniem
EN Outlet junction with PE
RU Разветвитель с заземлением FRENCH
UK Відгалужувач із заземленням FRENCH

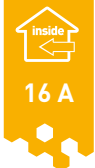

INFO



AE-RU0102-00

1 na 2, 2-way, 1 na 2, 1 na 2

5908231301253



PL Rozgałęziacz z uziemieniem
 EN Outlet junction with PE
 RU Разветвитель с заземлением SCHUKO
 UK Відгалужувач із заземленням SCHUCKO



AE-SC0102-00	biały, white, белый, білий	5908231360847
--------------	----------------------------	---------------



PL Rozgałęziacz z uziemieniem
 EN Outlet junction with PE
 RU Разветвитель с заземлением SCHUKO
 UK Відгалужувач із заземленням SCHUCKO



INFO



AE-SC0103-00	1 na 3 (schuko), 3-way (schuko), 1 на 3 (schuko), 1 на 3 (schuko)	5908231360854
--------------	--	---------------



PL Wtyczka płaska kątowa
 EN Plane angular plug
 RU Плоский угловой штекер
 UK Вилка плоска кутова



White

Black



INFO



AE-VA1UNI-00	biały, white, белый, білий	5901867171887
AE-VA1UNI-10	czarny, black, черный, чорний	5902801318849



PL Rozgałęziacz z uziemieniem
 EN Outlet junction with PE
 RU Разветвитель с заземлением FRENCH
 UK Відгалужувач із заземленням FRENCH

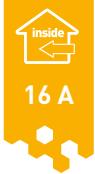

INFO



AE-RU0103-00	1 na 3, 3-way, 1 на 3, 1 на 3	5908231301277
--------------	-------------------------------	---------------



PL Oprawka ceramiczna
 EN Ceramic lamp holder
 RU Патрон керамический
 UK Керамічний патрон

MAX
100 W



AE-OCEF27-00	biały, white, белый, білий	5908231302120
--------------	----------------------------	---------------



PL Oprawka ceramiczna
 EN Ceramic lamp holder
 RU Патрон керамический
 UK Керамічний патрон

MAX
100 W



AE-OCEE14-00	biały, white, белый, білий	5908231302090
--------------	----------------------------	---------------



Installation fittings



PL Oprawka ceramiczna
EN Ceramic lamp holder
RU Патрон керамический
UK Керамічний патрон



MAX
100 W



AE-OCEE27-00

biały, white, белый, білий

5908231302106



PL Oprawka ceramiczna
EN Ceramic lamp holder
RU Патрон керамический
UK Керамічний патрон



MAX
100 W



AE-OCEE27-MM

biały, white, белый, білий

5902801340048



PL Oprawka ceramiczna
EN Ceramic lamp holder
RU Патрон керамический
UK Керамічний патрон



MAX
100 W



AE-OCEE40-00

biały, white, белый, білий

5902801227271



PL Oprawka
EN Lamp holder
RU Патрон
UK Патрон



MAX
100 W

5
years
warranty



AE-OPE27P-00

biały, white, белый, білий

5901867143327



PL Gniazdo do lamp E27
EN Lamp socket E27
RU Патрон для ламп E27
UK Патрон для ламп E27



MAX
60 W

E27

5
years
warranty



GZ-E27000-10

czarny, black, черный, чорний

5902801292620

GZ-E27000-00

biały, white, белый, білий

5902801256226



PL Przejściówka
EN Adapter
RU Переходник
UK Перехідник



MAX
50 W

5
years
warranty



INFO



AE-E14GU10-00

E14, GU10

biały, white, белый, білий

5908231391797



Installation fittings





PL Przejściówka
EN Adapter
RU Переходник
UK Перехідник



INFO



AE-E14E27-00	E14, E27	biały, white, белый, білий	5901867112156
--------------	----------	----------------------------	---------------



PL Przejściówka
EN Adapter
RU Переходник
UK Перехідник



INFO



AE-E27E14-00	E27, E14	biały, white, белый, білий	5908231391780
--------------	----------	----------------------------	---------------



PL Przejściówka
EN Adapter
RU Переходник
UK Перехідник



INFO



AE-27GU10-00	E27, GU10	biały, white, белый, білий	5908231391803
--------------	-----------	----------------------------	---------------



PL Przejściówka
EN Adapter
RU Переходник
UK Перехідник



INFO



AE-GU10E27-00	GU10, E27	biały, white, белый, білий	5908231302540
---------------	-----------	----------------------------	---------------



PL Przejściówka
EN Adapter
RU Переходник
UK Перехідник



INFO



AE-E40E27-00	E40, E27	biały, white, белый, білий	5901867124227
--------------	----------	----------------------------	---------------



PL Obręcz mocująca E14, E27
EN Ring for E14, E27 sockets
RU Кольцо для патронов E14, E27
UK Кільце для патронів E14, E27



INFO



AE-E27RING-10	E27	biały, white, белый, білий	5901867124221
AE-E14RING-10	E14		5901867124227



PL Wodoszczelny łącznik do przewodów elektrycznych
 EN Waterproof connector for electrical wiring
 RU Водонепроницаемый коннектор для электрических проводов
 UK Водонепроникний конектор для електричних проводів



WZL-2	tworzywo, plastic, пластмасса, пластик	czarny, black, черный, чорний	5901867122070
-------	--	-------------------------------	---------------



PL Wodoszczelny trójnik, łącznik do przewodów elektrycznych
 EN Waterproof "T"-shape connector for electrical wiring
 RU Водонепроницаемый тройник и соединитель для электрических проводов
 UK Водонепроникний трійник, конектор для електричних проводів



WZL-3	tworzywo, plastic, пластмасса, пластик	czarny, black, черный, чорний	5901867122094
-------	--	-------------------------------	---------------



PL Wodoszczelny trójnik, łącznik do przewodów elektrycznych
 EN Waterproof electrical wiring tee and connector
 RU Водонепроницаемый тройник и соединитель для электрических проводов
 UK Водонепроникний трійник, конектор для електричних проводів



WZL-4	tworzywo, plastic, пластмасса, пластик	czarny, black, черный, чорний	5902801016189
-------	--	-------------------------------	---------------



PL Kostka z osłonką izolacyjną do opraw
 EN Connection block with insulation sleeve for fixtures
 RU Клеммная колодка с крышкой для светильников
 UK Клемник з ізоляційним екраном для світильників



LZ-KOI2KO-10	czarny, black, черный, чорний	5901867199027
--------------	-------------------------------	---------------



PL Złączki zaciskowe - elastyczne
 EN Flexible connection terminals
 RU Зажимные муфты - гибкие
 UK Обтискний конектор, еластичний

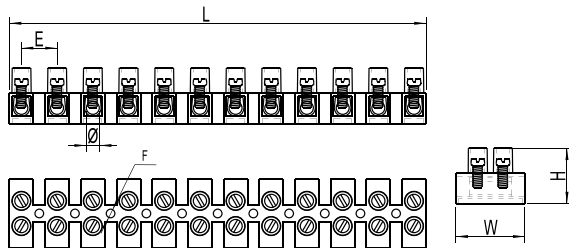

L (mm) W (mm) H (mm) E (mm) F (mm) Ø (mm)

	L (mm)	W (mm)	H (mm)	E (mm)	F (mm)	Ø (mm)
LZ-25MM00-00	93,5	16,8	12,3	8	2,5	3
LZ-40MM00-00	114,9	18,9	15,3	9,9	2,7	3,2
LZ-60MM00-00	129,1	20,7	16,5	11	3,1	4,2
LZ-100MM0-00	137,5	22,5	18,2	11,8	3,1	4,5
LZ-160MM0-00	164,5	25,5	20	14,1	3,4	5,5
LZ-250MM0-00	187,6	29,3	25,3	16	3,4	6,5



	A				
LZ-25MM00-00	3 A	polietylen, polietylen, полиэтилен, поліетилен	10	16 g	5908231331922
LZ-40MM00-00	6 A			26 g	5908231331939
LZ-60MM00-00	10 A			32 g	5908231331946
LZ-100MM0-00	15 A			46 g	5908231331892
LZ-160MM0-00	30 A			65 g	5908231331908
LZ-250MM0-00	60 A			96 g	5908231331915





PL Oslona sufitowa na kostkę elektryczną
 EN Ceiling guard for connection block
 RU Потолочная крышка для клеммной колодки
 UK Стельовий екран для електричного клемника



White

Black

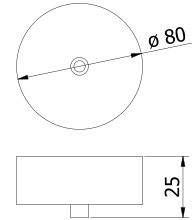

AE-MA8028-10	metal, metal, металл, метал metal,	biały, white, белый, білий	109 g	5902801336546
AE-MA8028-00		czarny, black, черный, чорний		5902801336553

PL Oslona sufitowa na kostkę elektryczną
 EN Ceiling cover for connection block
 RU Потолочная крышка для клеммной колодки
 UK Стельовий екран для електричного клемника



White

Black

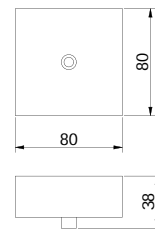

Installation fittings

AE-MAS80X80-10	tworzywo, plastic, пластмасса, пластик	biały, white, белый, білий	90 g	5902801245091
AE-MAS80X80-00		czarny, black, черный, чорний		5902801244742



- PL Osłona sufitowa na kostkę elektryczną
- EN Ceiling cover for connection block
- RU Потолочная крышка для клеммной колодки
- UK Стельовий екран для електричного клемника



AE-CANOPY-10	biały, white, белый, білий	5901867124234
--------------	----------------------------	---------------

- PL Statyw do opraw halogenowych i ledowych
- EN Halogen / LED fixture stand
- RU Штатив для галогенных и светодиодных прожекторов
- UK Штатив для галогенних і світлодіодних прожекторів

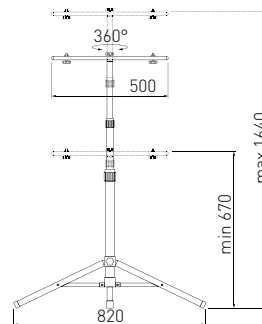

OH-ST2500-23	stal, steel, сталь, сталь	żółty, yellow, желтый, жовтий	2000 g	5908231360663
--------------	---------------------------	-------------------------------	--------	---------------





PL Kabel z wtyczką i włącznikiem, 2 m
 EN Cables with plug and switch, 2 m
 RU Кабель с вилкой и выключателем 2 м
 UK Кабель живлення 2 м з вилкою і вимикачем



LD-KABE2M-00

LD-KABE2M-10



LD-KABE2M-00	2 m	5908231335265
LD-KABE2M-10		5902801004018



PL Kabel z wtyczką
 EN Cables with plug
 RU Кабель с вилкой
 UK Кабель з вилкою



KB-W310HUG-20	1,5 m	5908231385871
KB-W313HUG-20	3 m	5902801003899



PL Zapłonnik
 EN Starter
 RU Стартер
 UK Стартер



INFO



OS-STA422-00	4-22 W, 230 V AC	5908231332578
OS-STA465-00	4-65 W, 230 V AC	5908231332585



PL Statecznik elektroniczny
EN Electric driver
RU Электронный балласт
UK Електронний пусковий пристрій

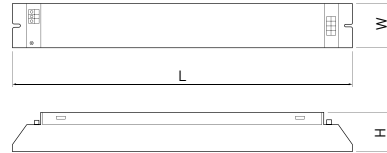

					LxWxH	
OS-SEL236-ZHQ	2 x 36 W / T8	70 g	metal, metal, металл, метал	320 x 32 x 28 mm	5902801038174	
OS-SEL418-ZHQ	4 x 18 W / T8	78 g			5902801038167	

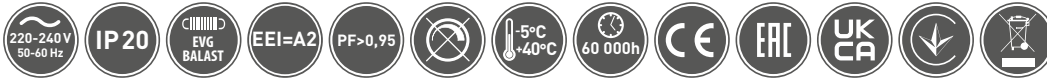

PL Statecznik elektroniczny
EN Electric driver
RU Электронный балласт
UK Електронний пусковий пристрій

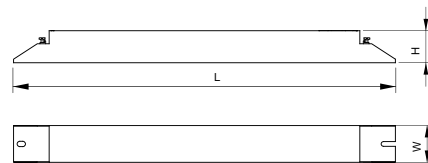

					LxWxH	
OS-NSEL158-00	58 W / T8	250 g	metal, metal, металл, метал	271 x 27 x 27 mm	5902801281266	
OS-NSEL136-00	36 W / T8	200 g			5902801281655	
OS-NSEL118-00	18 W / T8	180 g			5902801218729	





PL Zasilacz DALI
EN DALI power supply unit
RU Блоки питания DALI
UK Блок живлення DALI

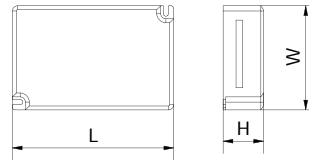

	CC	U OUTPUT	LxWxH mm		
BK-PUL030A-0700AD	250-700 mA	3-42V	104 x 68 x 31	170 g	5902801299377
BK-PUL042A-0700BD	250-700 mA	3-84V	104 x 68 x 21		5902801299483
BK-PUL042A-1100AD	600-1100 mA	3-42V	104 x 68 x 21		5902801299452
BK-PUL060A-2000AD	800-2000 mA	3-42V	124 x 80 x 31		5902801270758



PL Zasilacz DALI
EN DALI power supply unit
RU Блоки питания DALI
UK Блок живлення DALI



Installation fittings



	CC	U OUTPUT	LxWxH mm		
BK-BHL050-1000BZ	550-1000 mA	3-54V	355 x 30 x 21	300 g	5902801270741
BK-BHL060-1300BZ	850-1300 mA		285 x 30 x 21		5902801299537





PL Moduł awaryjny do paneli LED
 EN LED panel emergency module
 RU Аварийный модуль для светодиодной панели
 UK Аварійний модуль для світлодіодної панелі

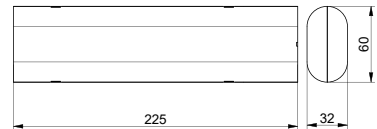

OA-MALEDPAN-00	3 h	PC	biały, white, белый, білий	525 g	5902801285400



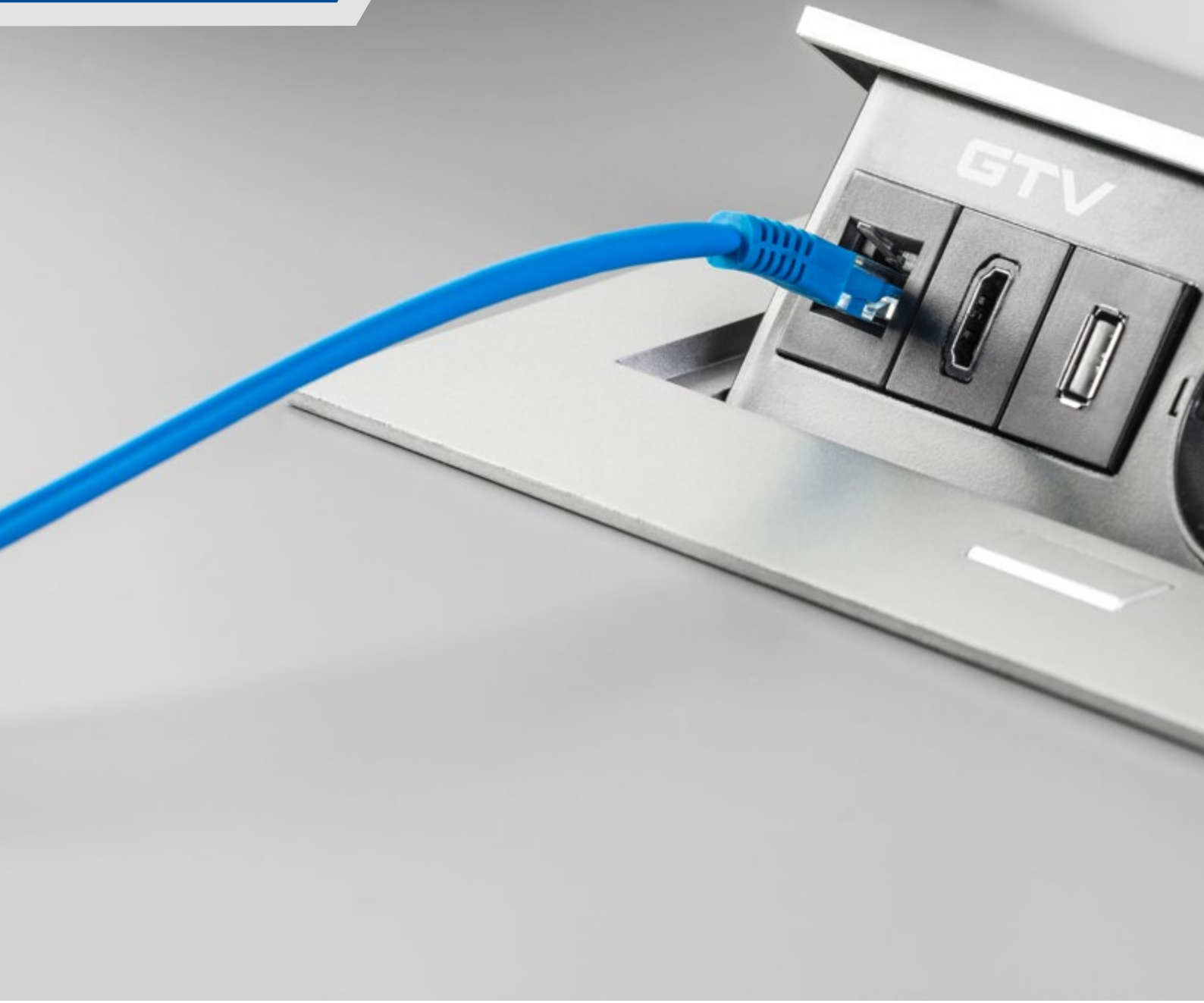



OŚWIETLENIE MEBLOWE / PROFILE LED
FURNITURE LIGHTING / LED PROFILES
ОСВЕЩЕНИЕ МЕБЕЛИ / ПРОФИЛИ ДЛЯ СВЕТОДИОДНЫХ ЛЕНТ
ОСВІТЛЕННЯ МЕБЛІВ / ПРОФІЛЬ ДЛЯ СВІТЛОДІОДНОЇ СТРИЧКИ

Taśmy LED / Profile LED LED strips / LED profiles Светодиодные ленты / Профили LED Стрічки led / Профілі led	401
Oprawy LED LED fixtures Светодиодные светильники Світлодіодні світильники	438
Aksesoria Accessories Аксессуары Акcesуари	446
Gniazda meblowe Power sockets Удлинитель Подовжувачі	475



TAŚMY LED / PROFILE LED
LED STRIPS / LED PROFILES
СВЕТОДИОДНЫЕ ЛЕНТЫ / ПРОФИЛИ LED
СТРІЧКИ LED / ПРОФІЛІ LED

W 5-ciu krokach skompletuj zestaw EASY CLICK
Complete the EASY CLICK set in 5 steps
Завершите набор EASY CLICK за 5 шагов
Складіть EASY CLICK за 5 кроків



1.

wyberz taśmę
select LED strip
выбрать светодиодную ленту
виберіть стрічку

wyberz ilość odcinków taśm led
select the number of sections of LED strips
выбрать количество секций светодиодных лент
виберіть кількість секцій світлодіодної стрічки

2.

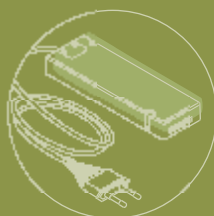

3.

dopasowany zasilacz
matched power supply
подходящий источник питания
відповідне джерело живлення

wyberz profil, profile sprzedawane są jako gotowe 2 m zestawy, zawierające profil, osłonkę i 2 zaślepki
select profile profiles are sold as ready-made 2 m sets containing a profile, a cover and 2 end caps
Выбери профиль, профиль продаётся как готовые 2 м наборы, состоящие из профиля, рассеивателя 2 м и 2 заглушки
виберіть профіль профілі продаються у вигляді готового комплекту довжиною 2 м, що включає профіль, кришку і 2 заглушки

4.

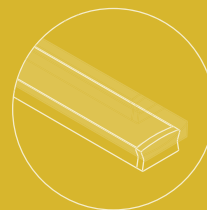

5.

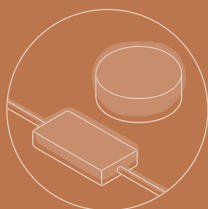

wyberz włącznik
select a switch
выберите выключатель
виберіть вимикач

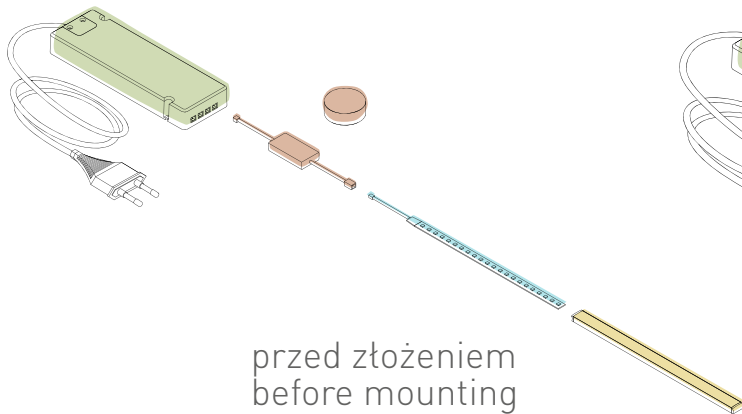



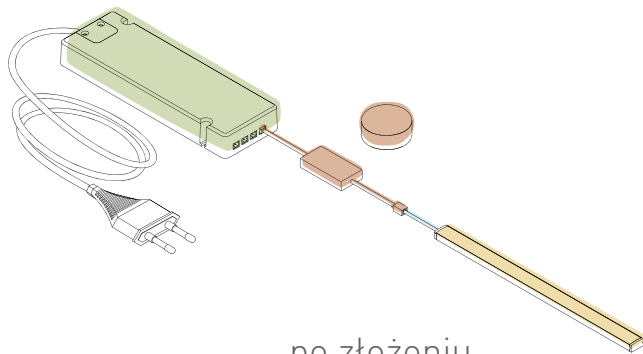



przed złożeniem
before mounting
перед монтажом
перед складанням



po złożeniu
after mounting
после монтажа
після складання

przykładowy schemat instalacji
sample installation diagram
примерная схема инсталляции
зразок діаграми установка

-  taśma LED w profilu
LED strip in a profile
светодиодная лента в профиле
Світлодіодна стрічка в профілі
-  przewód od taśmy led do wyłącznika
cable from LED strip to a switch
кабель от светодиодной ленты к выключателю
Шнур живлення світлодіодної стрічки від вимикача
-  przewody wyłącznika
switch cables
кабель выключателя
Шнур живлення від блоку живлення до вимикача
-  przewód od gniazda 230V do zasilacza
cable from 230V mains socket to LED driver
кабель от гнезда 230 В для блока питания
Шнур живлення від розетки 220В до блоку живлення
-  wyłącznik
switch
выключатель
Вимикач
-  zasilacz
LED driver
блок питания
Блок живлення





LD-3528-300-20-ZB	12 VDC 4,8 W/1 m 17 W/5 m	300 lm/m	● 6500 K	20	120°	8	60/m	5	5901867152053
LD-3528-300-20-NE4P			● 4000 K						5902801224911
LD-3528-300-20-CB			● 3200 K						5901867152022
LD-3528-300-65-ZB		280 lm/m	● 6500 K	5901867152114					
LD-3528-300-65-NE4			● 4000 K	5902801370632					
LD-3528-300-65-CB			● 3200 K	5901867152084					
LD-3528-300-20-NI	-	niebieski/ blue/ синий/ синій	5901867198983						
LD-3528-600-20-ZB	12 VDC 9,6 W/1 m 28 W/5 m	550 lm/m	● 6500 K	20		8	120/m	2,5	5901867152251
LD-3528-600-20-NE4			● 4000 K						5902801370465
LD-3528-600-20-CB			● 3200 K						5901867152312
LD-3528-600-65-ZB		520 lm/m	● 6500 K	5901867152374					
LD-3528-600-65-NE4			● 4000 K	5902801370625					
LD-3528-600-65-CB			● 3200 K	5901867152343					
LD-2835-300-20-ZB	12 VDC 6 W/1 m 21 W/5 m	750 lm/m	● 6500 K	20	8	60/m	5	5901867152640	
LD-2835-300-20-NE4P			● 4000 K					5902801224980	
LD-2835-300-20-CB			● 3200 K					5901867152619	
LD-2835-300-65-ZB		700 lm/m	● 6500 K	5901867152701					
LD-2835-300-65-NE4			● 4000 K	5902801295386					
LD-2835-300-65-CB			● 3200 K	5901867152671					
LD-2835-300-20-CBN	12 VDC 11 W/1 m 33 W/5 m	1000 lm/m	● 3200 K	20		8	120/m	2,5	5902801285585
LD-2835-300-20-ZBN			● 6500 K						5902801285530
LD-2835-300-20-NE4N			● 4000 K						5902801285738
LD-2835-300-65-CBN		900 lm/m	● 3200 K	5902801294785					
LD-2835-300-65-ZBN			● 6500 K	5902801285707					
LD-2835-300-65-NE4N			● 4000 K	5902801295386					
LD-2835-600-20-ZB	12 VDC 19 W/1 m 60 W/5 m	1600 lm/m	● 6500 K	20	10	120/m	2,5	5902801231933	
LD-2835-600-20-NE4			● 4000 K					5902801268700	
LD-2835-600-20-CB			● 3200 K					5902801231537	
LD-2835-600-65-ZB		1350 lm/m	● 6500 K	5902801231605					
LD-2835-600-65-NE4			● 4000 K	5902801370519					
LD-2835-600-65-CB			● 3200 K	5902801231360					





LD-2835-600-5MM-20-ZB	12 VDC 10 W/1 m 33 W/5 m	750 lm/m	● 6500 K	20	120°	5	120/m	2,5	5902801285448
LD-2835-600-5MM-20-NE4			● 4000 K						5902801285547
LD-2835-600-5MM-20-CB			● 3200 K						5902801285486
LD-2835-60-60-20-CCT	12 VDC 10 W/1 m 30 W/5 m	700 lm/m	● 3200 K ● 6500 K	20		8		5	5902801260292
LD-5050-300-20-ZB	12 VDC 14,4 W/1 m 44 W/5 m	900 lm/m	● 6500 K	65	120°	10	60/m	5	5901867152497
LD-5050-300-20-NE4			● 4000 K						5902801370717
LD-5050-300-20-CB			● 3200 K						5901867152466
LD-5050-300-65-ZB	12 VDC 14,4 W/1 m 44 W/5 m	850 lm/m	● 6500 K	65	120°	10	60/m	5	5901867152558
LD-5050-300-65-NE4			● 4000 K						5902801370502
LD-5050-300-65-CB			● 3200 K						5901867152527
LD-5630-300-20-ZB	12 VDC 16 W/1 m 50 W/5 m	1750 lm/m	● 6500 K	20	120°	10	60/m	5	5901867152763
LD-5630-300-20-NE4			● 4000 K						5902801358012
LD-5630-300-20-CB			● 3200 K						5901867152732
LD-5630-300-65-ZB	12 VDC 16 W/1 m 50 W/5 m	1700 lm/m	● 6500 K	65	120°	10	60/m	5	5901867152824
LD-5630-300-65-NE4			● 4000 K						5902801358036
LD-5630-300-65-CB			● 3200 K						5901867152794
LD-3014-1200-20-ZB	12 VDC 19 W/1 m 53 W/5 m	1300 lm/m	● 6500 K	20	120°	10	240/m	1,25	5902801231766
LD-3014-1200-20-NE4			● 4000 K						5902801232077
LD-3014-1200-20-CB			● 3200 K						5902801267154
LD-RGB-150-20	12 VDC max 7,2 W/1 m 22 W/5 m	-	● RGB	65	120°	10	30/m	10	5901867152404
LD-RGB-150-65			● RGB						5901867152435
LD-RGBW-300-20	12 VDC max 17 W/1 m	-	● RGBW	20					60/m



PL Taśma LED FLASH 50 m
 EN LED strip FLASH 50 m
 RU Светодиодная лента FLASH 50 m
 UK Світлодіодна стрічка FLASH 50 m



LD-3528-300-20-ZB-50	12 VDC 4,8 W/m	300 lm/m	● 6500 K	20	120°	8 mm	60/m	5901867172099	
LD-3528-300-20-NE4P-50			● 4000 K					5902801252150	
LD-3528-300-20-CB-50			● 3200 K					5901867172082	
LD-3528-600-20-ZB-50	12 VDC 9,6 W/m	550 lm/m	● 6500 K				120/m	5	5902801370564
LD-3528-600-20-NE4-50			● 4000 K						5902801370403
LD-3528-600-20-CB-50			● 3200 K						5902801370601
LD-2835-300-20-ZB-50	12 VDC 6 W/m	750 lm/m	● 6500 K			10 mm	60/m	5901867195142	
LD-2835-300-20-NE4P-50			● 4000 K					5902801225000	
LD-2835-300-20-CB-50			● 3200 K					5901867195128	
LD-5050-300-20-NE4-50	12DC 14,4W/m	900 lm/m	● 4000 K				5902801370427		
LD-5630-300-20-NE4-50	12DC 16W/m	1750 lm/m	● 4000 K	5902801358470					



PL Taśma LED FLASH
EN LED strip FLASH
RU Светодиодная лента FLASH
UK Світлодіодна стрічка FLASH



LD-2835-24V-300-20-ZB	24 V DC 12 W/1 m 48 W/5 m	780 lm/m	● 6500 K	20	120°	8 mm	60/m	10	5902801245664
LD-2835-24V-300-20-NE4			● 4000 K						5902801245787
LD-2835-24V-300-20-CB			● 3200 K						5902801245633
LD-2835-24V-600-20-ZB	24 V DC 21 W/1 m 78 W/5 m	1350 lm/m	● 6500 K			10 mm	120/m	5	5902801245701
LD-2835-24V-600-20-NE4			● 4000 K						5902801245640
LD-2835-24V-600-20-CB			● 3200 K						5902801245855



PL Zestaw RGB, taśma LED 5 m, kontroler, zasilacz, pilot
EN RGB-set, LED band 5 m, RGB controller, LED-transformator, remote control
RU Комплект RGB, лента LED 5 м, контролер, трансформатор, пульт
UK Набор RGB, світлодіодна стрічка 5 м, контролер, блок живлення, пульт

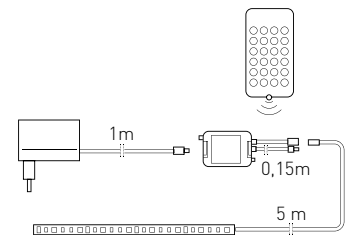

LD-ZL5RGB150-00	12V	RGB	tworzywo, plastic, пластик, пластик	10	10	5902801025839



PL Taśma LED COB
EN LED strip COB
RU Светодиодная лента COB
UK Світлодіодна стрічка COB



Folder	W	Light	Color	IP	Beam	mm	LED	cm	Barcode
LD-COB12V-20-ZBN	12V, 8W/m	600 lm/W	6500 K	IP20	1800	8 mm	320 led	2,5 cm	5902801364129
LD-COB12V-20-CBN		600 lm/W	2700 K						5902801363955
LD-COB12V-20-NEN		700 lm/W	4000 K						5902801363993
LD-COB12V-20-ZBPQ	12V, 10W/m	800 lm/W	6500 K				480 led		5902801364198
LD-COB12V-20-CBPQ		750 lm/W	2700 K						5902801363870
LD-COB12V-20-NEPQ		800 lm/W	4000 K						5902801364228



PL Taśma LED COB
EN LED strip COB
RU Светодиодная лента COB
UK Світлодіодна стрічка COB



Folder	W	Light	Color	IP	Beam	mm	LED	cm	Barcode
LD-COB24V-20-ZBN	24V, 8W/m	650 lm/W	6500 K	IP20	1800	8 mm	320 led	2,5 cm	5902801423666
LD-COB24V-20-CBN		600 lm/W	2700 K						5902801424090
LD-COB24V-20-NEN		600 lm/m	4000 K						5902801424083



PL Taśma LED NEON FLEX
EN LED strip NEON FLEX
RU Светодиодная лента NEON FLEX
UK Світлодіодна стрічка NEON FLEX



LD-NF-12V6x12-65-ZB	12 VDC 12 W/1 m 40 W/5 m	200 lm/m	● 6500 K	IP 65	120°	6 mm	120/m	1	5902801366857
LD-NF-12V6x12-65-NE			● 4000 K						5902801367106
LD-NF-12V6x12-65-CB			● 3000 K						5902801365973

LD-ZASNF-12V6X12-65	zaślepka, end cap, заглушка, кінцевий ковпачок	5902801388705
LD-UNF-12V6X12-6X	uchwyty, mounting clip, держатель, ручка	5902801388750

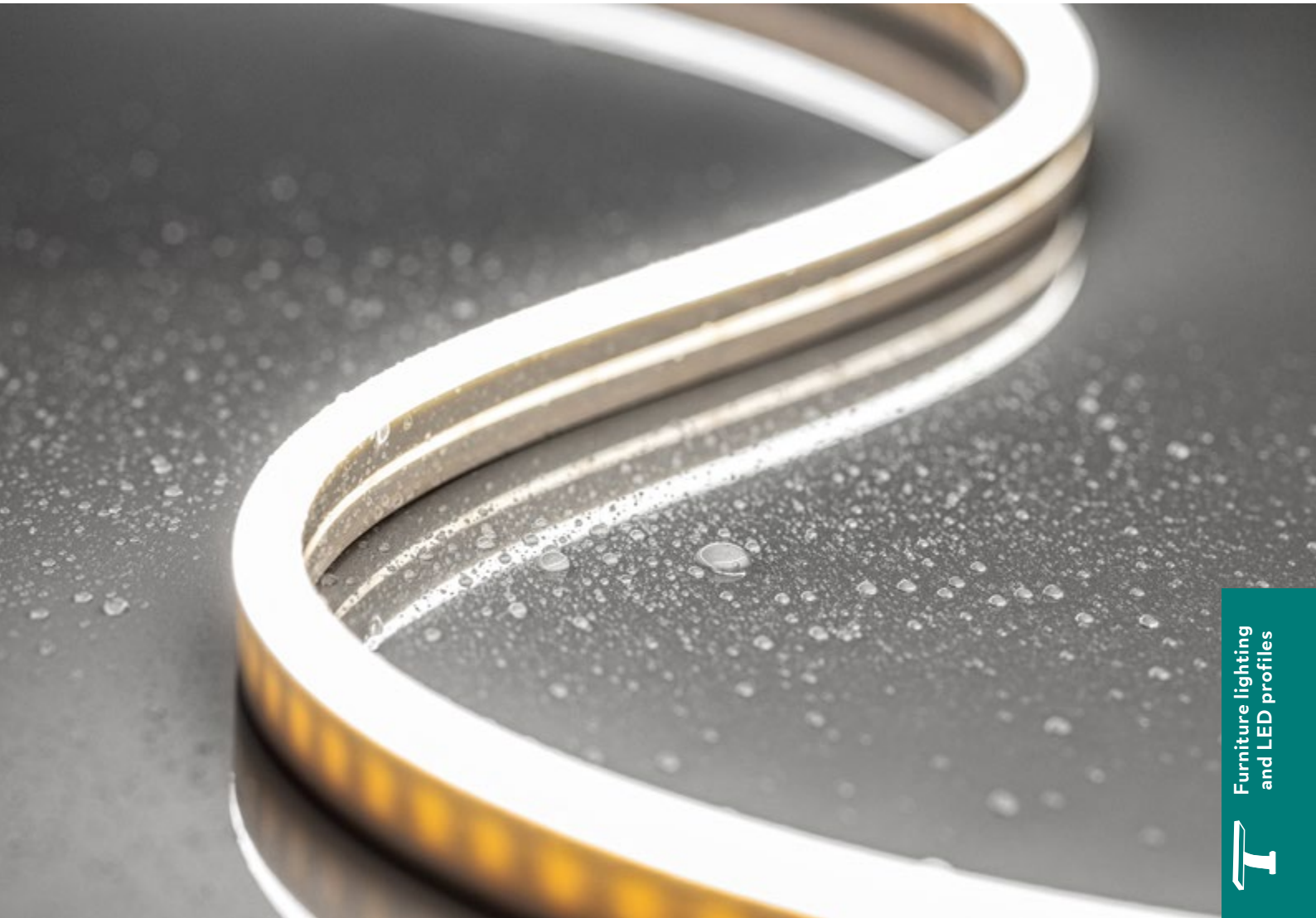

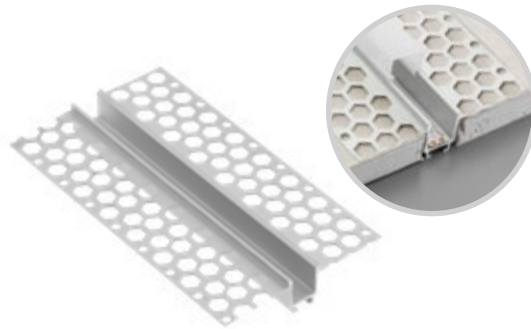

	L m	i				
PA-GLAXGKL3M-00C	3	profil, profile, профиль, профіль	srebrny, silver, серебристый, срібний	aluminium, aluminium, алюминий, алюміній	5902801334429	
PA-CPGLAXL-00	-	łącznik liniowy, straight connector, линейный соединитель, з'єднувач, лінійний			stal nierdzewna, stainless steel, нержавеющая сталь, нержавіюча сталь	5902801295430
PA-CPGLAXAH-00	-	łącznik poziomy, horizontal connector, горизонтальный соединитель, з'єднувач, горизонтальний				5902801295300
PA-CPGLAXAV-00	-	łącznik pionowy, vertical connector, вертикальный соединитель, з'єднувач, вертикальний				5902801295317
PA-OSMLGLAXM3M-00	3	osłonka, cover, крышка, кришка	mleczna, frosted, молочный, молочний	PC	5902801024047	
PA-OSMLGLAXMK3M-00	3	osłonka kwadratowa, square cover, крышка квадратная, кришка квадратна			5902801273926	
PA-OSMLGLAXMO3M-00	3	osłonka okrągła, round cover, крышка круглая, кришка кругла			5902801274152	
PA-OSMLGLAXT3M-00	3	osłonka trójkątna, triangular cover, крышка треугольная, кришка трикутна			5902801274084	
PA-OSCLGLAXM3M-00	3	osłonka mini, cover mini, крышка мини, мінікришка			czarny, black, черный, чорний	5902801395581

Ostonki / Covers / Крышки / Кришки:

Akcesoria / Accessories / Аксессуары / Аксесуари:

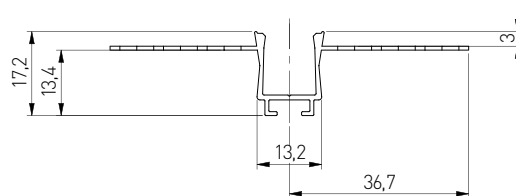





PA-GLAXGKS3M-00C	3	profil, profile, профиль, профіль	srebrny, silver, серебристый, срібний	aluminium, aluminium, алюминий, алюміній	5902801335204
PA-CPGLAXL-00	-	łącznik liniowy, straight connector, линейный соединитель, з'єднувач, лінійний		stal nierdzewna, stainless steel, нержавеющая сталь, нержавіюча сталь	5902801295430
PA-CPGLAXAH-00	-	łącznik poziomy, horizontal connector, горизонтальный соединитель, з'єднувач, горизонтальний			5902801295300
PA-CPGLAXAV-00	-	łącznik pionowy, vertical connector, вертикальный соединитель, з'єднувач, вертикальний			5902801295317
PA-OSMLGLAXM3M-00	3	osłonka, cover, крышка, кришка	mleczna, frosted, молочный, молочний	PC	5902801024047
PA-OSMLGLAXMK3M-00	3	osłonka kwadratowa, square cover, крышка квадратная, кришка квадратна			5902801273926
PA-OSMLGLAXMO3M-00	3	osłonka okrągła, round cover, крышка круглая, кришка кругла			5902801274152
PA-OSMLGLAXT3M-00	3	osłonka trójkątna, triangular cover, крышка треугольная, кришка трикутна			5902801274084
PA-OSCLGLAXM3M-00	3	osłonka mini, cover mini, крышка мини, мінікришка	czarny, black, черный, чорний		5902801395581

Oslonki / Covers / Крышки / Кришки:

Akcesoria / Accessories / Аксессуары / Аксесуари:

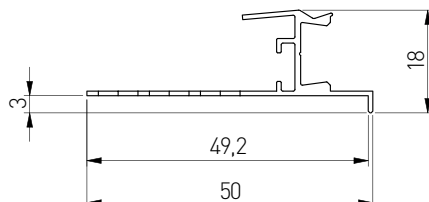



DO
something
(today)
THAT YOUR
FUTURE SELF
WILL
THANK YOU
for

BE
BRAVE

Better
days are
coming.
They're
called
Saturday and
Sunday.

Smile
you
are
beaut-
iful.

the
time
is
now.

DO
WHAT
YOU
LOVE

Al
you
is
lo
BRA

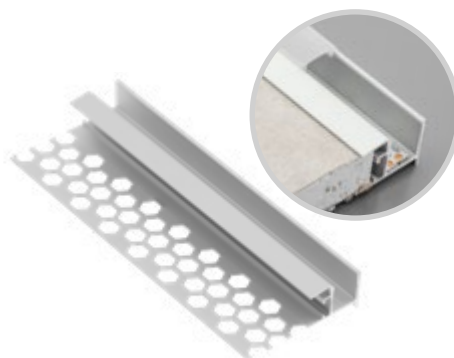

PA-GLAXGKW3M-00C	3	profil, profile, профиль, профіль	srebrny, silver, серебристый, срібний	aluminium, aluminium, алюминий, алюміній	5902801334641
PA-CPGLAXL-00	-	łącznik liniowy, straight connector, линейный соединитель, з'єднувач, лінійний			5902801295430
PA-CPGLAXAH-00	-	łącznik poziomy, horizontal connector, горизонтальный соединитель, з'єднувач, горизонтальний		stal nierdzewna, stainless steel, нержавеющая сталь, нержавіюча сталь	5902801295300
PA-CPGLAXAV-00	-	łącznik pionowy, vertical connector, вертикальный соединитель, з'єднувач, вертикальний			5902801295317
PA-OSMLGLAXM3M-00	3	osłonka, cover, крышка, кришка	mleczna, frosted, молочный, молочний	PC	5902801024047
PA-OSMLGLAXMK3M-00	3	osłonka kwadratowa, square cover, крышка квадратная, кришка квадратна			5902801273926
PA-OSMLGLAXMO3M-00	3	osłonka okrągła, round cover, крышка круглая, кришка кругла			5902801274152
PA-OSMLGLAXT3M-00	3	osłonka trójkątna, triangular cover, крышка треугольная, кришка трикутна			5902801274084
PA-OSCLGLAXM3M-00	3	osłonka mini, cover mini, крышка мини, мінікришка	czarny, black, черный, чорний		5902801395581

Ostonki / Covers / Крышки / Кришки:

Akcesoria / Accessories / Аксессуары / Аксесуари:



PA-CPGLAXL-00



PA-CPGLAXAH-00



PA-CPGLAXAV-00

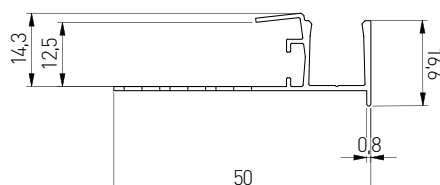



PL Profil GLAX kątowy, wewnętrzny
 EN GLAX internal angle profile
 RU Профиль GLAX угловой внутренний
 UK Профіль GLAX кутовий, внутрішній

NEW



DOBRY WZÓR
2019

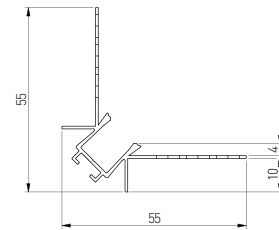

PA-GLAXGKWK3M-00C	3	profil, profile, профиль, профіль		aluminium, aluminium, алюминий, алюміній	5902801334580
PA-CPGLAXL-00	-	łącznik liniowy, straight connector, линейный соединитель, з'єднувач, лінійний	srebrny, silver, серебристый, срібний	stal nierdzewna, stainless steel, нержавеющей сталь, нержавіюча сталь	5902801295430
PA-CPGLAXAH-00	-	łącznik poziomy, horizontal connector, горизонтальный соединитель, з'єднувач, горизонтальний			5902801295300
PA-CPGLAXAV-00	-	łącznik pionowy, vertical connector, вертикальный соединитель, з'єднувач, вертикальний			5902801295317
PA-OSMLGLAXM3M-00	3	osłonka, cover, крышка, кришка	mleczna, frosted, молочный, молочний	PC	5902801024047
PA-OSMLGLAXMK3M-00	3	osłonka kwadratowa, square cover, крышка квадратная, кришка квадратна			5902801273926
PA-OSMLGLAXMO3M-00	3	osłonka okrągła, round cover, крышка круглая, кришка кругла			5902801274152
PA-OSMLGLAXT3M-00	3	osłonka trójkątna, triangular cover, крышка треугольная, кришка трикутна			5902801274084
PA-OSCLGLAXM3M-00	3	osłonka mini, cover mini, крышка мини, мінікришка	czarny, black, черный, чорний		5902801395581

Ostonki / Covers / Крышки / Кришки:

Aksesoria / Accessories / Аксессуары / Аксессуары:



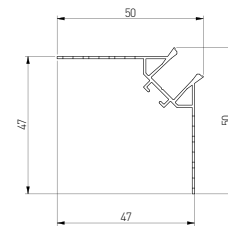
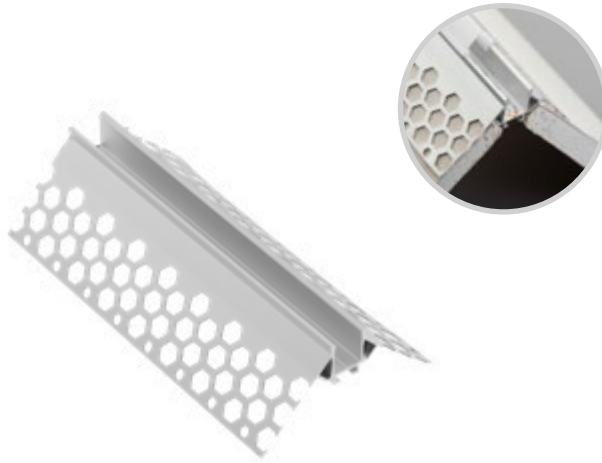

Folder	L m	i			Barcode
PA-GLAXGKZK3M-00C	3	profil, profile, профиль, профіль	srebrny, silver, серебристый, срібний	aluminium, aluminium, алюминий, алюміній	5902801334498
PA-CPGLAXL-00	-	łącznik liniowy, straight connector, линейный соединитель, з'єднувач, лінійний		stal nierdzewna, stainless steel, нержавеющая сталь, нержавіюча сталь	5902801295430
PA-CPGLAXAH-00	-	łącznik poziomy, horizontal connector, горизонтальный соединитель, з'єднувач, горизонтальний			5902801295300
PA-CPGLAXAV-00	-	łącznik pionowy, connector vertical, вертикальный соединитель, з'єднувач, вертикальний			5902801295317
PA-OSMLGLAXM3M-00	3	osłonka, cover, крышка, кришка	mleczna, frosted, молочный, молочний	PC	5902801024047
PA-OSMLGLAXMK3M-00	3	osłonka kwadratowa, square cover, крышка квадратная, кришка квадратна			5902801273926
PA-OSMLGLAXMO3M-00	3	osłonka okrągła, round cover, крышка круглая, кришка кругла			5902801274152
PA-OSMLGLAXT3M-00	3	osłonka trójkątna, triangular cover, крышка треугольная, кришка трикутна			5902801274084
PA-OSCLGLAXM3M-00	3	osłonka mini, cover mini, крышка мини, мінікришка	czarny, black, черный, чорний		5902801395581

Ostonki / Covers / Крышки / Кришки:

Aksesoria / Accessories / Аксессуары / Аксесуари:



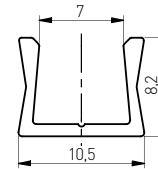
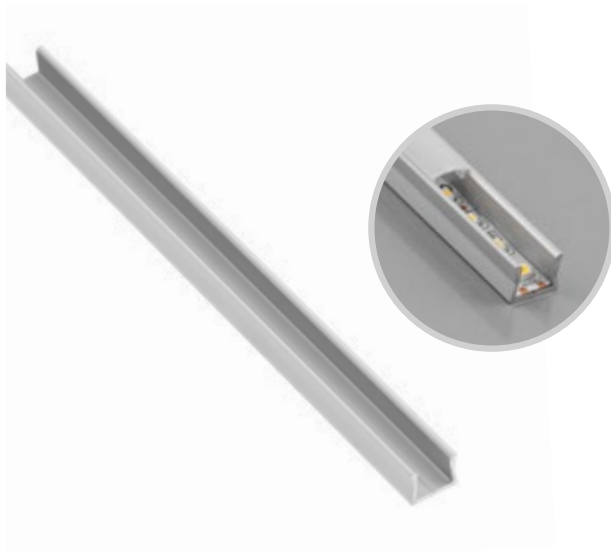

Wąska linia światła,
Brak punktów świetlnych przy użyciu dedykowanej taśmy LED o szerokości 5 mm
Narrow line of light.
No visible points of light due to dedicated 5mm LED strip
Узкая линия света.
Отсутствуют пункты свечения при использовании специальной ленты LED шириной 5 мм
Вузька лінія світла,
Відсутність світлових точок при використанні призначеної стрічки LED шириною 5 мм

PA-GLAXMICNK-AL	2	profil, profile, профиль, профіль	srebrny, silver, серебристый, срібний	aluminium, aluminium, алюминий, алюміній	5902801281549
PA-GLAXMICNK3M-AL	3				5902801281495
PA-OSMLGLAXMIC-00N	2	osłonka mikro, cover micro, крышка микро, мікрокришка	mleczna, frosted, молочная, молочний	PC	5902801359910
PA-OSMLGLAXMIC3M-00N	3				5902801337239
PA-ZASGLAXMICNK-00	-	zaślepka, end cap, заглушка, кінцевий ковпачок	szary, gray, серый, сірий	ABS	5902801200274
PA-SPRGLAXMIC-00	-	uchwyt, mounting clip, держатель, ручка	srebrny, silver, серебристый, срібний	stal nierdzewna, stainless steel, нержавеющая сталь, нержавіюча сталь	5902801244711

Ostonki / Covers / Крышки / Кришки:



PA-OSMLGLAXMIC-00N
PA-OSMLGLAXMIC3M-00N

Zaślepki / End caps / Заглушки / Кінцеві ковпачки:



PA-ZASGLAXMICNK-00

Uchwyt, mounting clip, держатель, кліпса монтажна,



PA-SPRGLAXMIC-00



PL Profil GLAX nakładany mini
EN GLAX profile mini surface mounted
RU Профиль GLAX накладной мини
UK Профіль GLAX накладний, mini

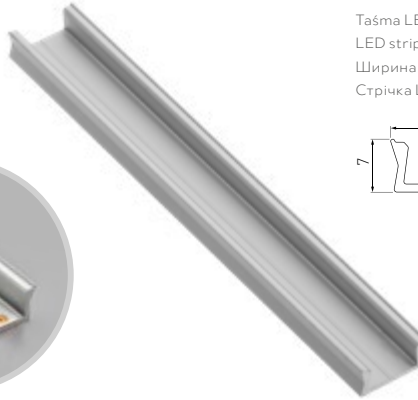

Taśma LED max 10 mm szerokości
LED strip width max 10 mm
Ширина светодиодной ленты не более 10 мм
Стрічка LED максимум 10 мм шириною

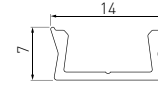

PA-GLAXMNK-AL	2	profil, profile, профиль, профіль	srebrny, silver, серебристый, срібний	aluminium, aluminium, алюминий, алюміній	5902801010316
PA-GLAXMNK-AL-20M			czarny, black, черный, чорний		5902801256660
PA-GLAXMNK-AL-10			biały, white, белый, білий		5902801256684
PA-GLAXMNK-AL-90			szampan, champagne, шампань, шампань		5902801256738
PA-GLAXMNK3M-AL	3		srebrny, silver, серебристый, срібний		5902801010781
PA-GLAXMNK3M-AL-20M			czarny, black, черный, чорний		5902801255854
PA-GLAXMNK3M-AL-10			biały, white, белый, білий		5902801255779
PA-OSMLGLAXM-00	2	osłonka mini, cover mini, крышка мини, мінікришка	mleczna, frosted, молочная, молочный	PC	5902801024023
PA-OSMLGLAXM3M-00	3		transparentna, transparent, прозрачная, прозрачный		5902801024047
PA-OSTRGLAXM-00	2		transparentna, transparent, прозрачная, прозрачный		5902801024030
PA-OSTRGLAXM3M-00	3		czarny, black, черный, чорний		5902801024054
PA-OSCLGLAXM-00	2		czarny, black, черный, чорний		5902801395437
PA-OSCLGLAXM3M-00	3		czarny, black, черный, чорний		5902801395581
PA-OSMLGLAXMK-00	2	osłonka kwadratowa, square cover, крышка квадратная, кришка квадратна	mleczna, frosted, молочная, молочный		5902801040511
PA-OSMLGLAXMO-00		osłonka okrągła, round cover, крышка круглая, кришка кругла	mleczna, frosted, молочная, молочный		5902801222702
PA-ZASGLAXMNK-00	-	zaślepka standard, standard end cap, заглушка стандартная, кінцевий ковпачок стандартний	szary, gray, серый, сірий	ABS	5902801024061
PA-ZASGLAXMNK-10			biały, white, белый, білий		5902801241536
PA-ZASGLAXMNK-90			szampan, champagne, шампань, шампань		5902801245084
PA-ZASGLAXMNK-20M			czarny mat, black matt, чёрный матовый, чорний матовый		5902801245268
PA-ZASGLAXMNNK-00	-	zaślepka kwadratowa, square end cap, заглушка квадратная, кінцевий ковпачок квадратный	szary, gray, серый, сірий		5902801222962
PA-ZASGLAXMNKO-00	-	zaślepka okrągła, round end cap, заглушка круглая, кінцевий ковпачок круглый	szary, gray, серый, сірий		5902801222986
PA-SPRGLAXM-00	-	uchwyt, mounting clip, держатель, ручка	srebrny, silver, серебристый, срібний	stal nierdzewna, stainless steel, нержавеющей сталь, нержавіюча сталь	5902801244711

Oslonki / Covers / Крышки / Кришки:



PA-OSMLGLAXM-00
PA-OSMLGLAXM3M-00

PA-OSTRGLAXM-00
PA-OSTRGLAXM3M-00

PA-OSCLGLAXM-00
PA-OSCLGLAXM3M-00

PA-OSMLGLAXMO-00

PA-OSMLGLAXMK-00

Zaślepki / End caps / Заглушки / Кінцеві ковпачки:



PA-ZASGLAXMNK-00

PA-ZASGLAXMNNK-00

PA-ZASGLAXMNKO-00

Uchwyt, mounting clip, держатель, кліпса монтажна,

PA-SPRGLAXM-00

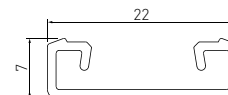

PA-GLAXNK-AL	2	profil, profile, профиль, профіль	srebrny, silver, серебристый, срібний	aluminium, aluminium, алюминий, алюміній	5901867127037
PA-GLAXNK3M-AL	3				5901867196606
PA-OSMLGLAX-00	2	oslonka mini, cover mini, крышка мини, мінікришка	mleczna, frosted, молочная, молочний	PC	5901867111999
PA-OSMLGLAX3M-00	3				5901867197610
PA-OSTRGLAX-00	2				transparentna, transparent, прозрачная, прозорий
PA-OSTRGLAX3M-00	3				5901867197627
PA-ZASGLAXNK-00	-	zaślepka, end cap, заглушка, кінцевий ковпачок	szary, gray, серый, сірий	ABS	5901867136411

Oslonki / Covers / Крышки / Кришки:



PA-OSMLGLAX-00
PA-OSMLGLAX3M-00

PA-OSTRGLAX-00
PA-OSTRGLAX3M-00

Zaślepki / End caps / Заглушки / Кінцеві ковпачки:



PA-ZASGLAXNK-00

PL Profil GLAX nakładany mini, wysoki
EN Profile GLAX surface mounted mini, high
RU Профиль GLAX накладной мини, высокий
UK Профіль GLAX накладний, міні, високий

Brak widocznych punktów świetlnych
Taśma LED max 10 mm szerokości
No visible points of light
LED strip width max 10 mm
Нет видимых точек света
Ширина светодиодной ленты не более 10 мм
Відсутність видимих світлових точок
Стрічка LED максимум 10 мм шириною.



White

Black

Silver

Champagne

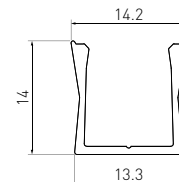

	L m	i			
PA-GLAXMKNW-AL	2	profil, profile, профиль, профіль	srebrny, silver, серебристый, срібний	aluminium, aluminium, алюминий, алюміній	5902801027468
PA-GLAXMKNW-AL-20M			czarny, black, черный, чорний		5902801256929
PA-GLAXMKNW-AL-10			biały, white, белый, білий		5902801256851
PA-GLAXMKNW-AL-90			szampan, champagne, шампань, шампань		5902801256813
PA-OSMLGLAXM-00	2	osłonka mini, cover mini, крышка мини, мінікришка	mleczna, frosted, молочная, молочний	PC	5902801024023
PA-OSTRGLAXM-00			transparentna, transparent, прозрачная, прозорий		5902801024030
PA-OSCLGLAXM-00			czarny, black, черный, чорний		5902801395437
PA-ZASGLAXMKNW-00	-	zaślepka, end cap, заглушка, кінцевий ковпачок	szary, gray, серый, сірий	ABS	5902801223181
PA-ZASGLAXMKNW-10			biały, white, белый, білий		5902801241857
PA-ZASGLAXMKNW-90			szampan, champagne, шампань, шампань		5902801241543
PA-ZASGLAXMKNW-20M			czarny mat, black matt, чёрный матовый, чорний матовий		5902801241802
PA-SPRGLAXM-00	-	uchwyt, mounting clip, держатель, ручка	srebrny, silver, серебристый, срібний	stal nierdzewna, stainless steel, нержавеющая сталь, нержавіюча сталь	5902801244711

Ostonki / Covers / Крышки / Кришки:

Zaślepka / End cap / Заглушка / кінцевий ковпачок:

Uchwyt / mounting clip / держатель / ручка



PA-OSMLGLAXM-00

PA-OSCLGLAXM-00

PA-OSTRGLAXM-00

PA-ZASGLAXMKNW-00

PA-SPRGLAXM-00

PL Profil GLAX wpuszczany, mikro
EN GLAX profile recessed, micro
RU Профиль GLAX врезной, микро
UK Профіль GLAX врізний, мікро

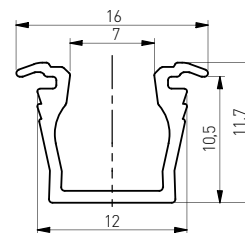
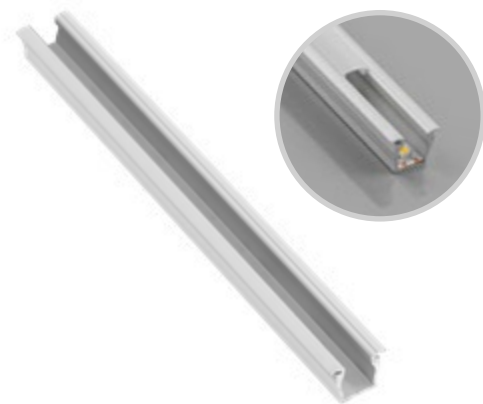

Wąska linia światła,
Brak punktów świetlnych przy użyciu
dedykowanej taśmy LED o szerokości 5 mm
Narrow line of light.
No visible points of light due to dedicated
5mm LED strip
Узкая линия света.
Отсутствуют пункты свечения при
использовании специальной ленты LED
шириной 5 мм
Вузька лінія світла,
Відсутність світлових точок при
використанні
призначеної стрічки LED шириною 5 мм

PA-GLAXMIC-AL	2	profil, profile, профиль, профіль	srebrny, silver, серебристый, срібний	aluminium, aluminium, алюминий, алюміній	5902801281600
PA-GLAXMIC3M-AL	3				5902801281839
PA-OSMLGLAXMIC-00N	2	oslonka mikro, cover micro, крышка микро, мікрокришка	mleczna, frosted, молочная, молочний	PC	5902801359910
PA-OSMLGLAXMIC3M-00N	3				5902801337239
PA-ZASGLAXMIC-00	-	zaślepka, end cap, заглушка, кінцевий ковпачок	szary, gray, серый, сірий	ABS	5902801200205

Osłonki / Covers / Крышки / Кришки:

Zaślepka / End cap / Заглушка / кінцевий ковпачок:



PA-OSMLGLAXMIC-00N
PA-OSMLGLAXMIC3M-00N



PA-ZASGLAXMIC-00

PL Profil GLAX wpuszczany
EN Profile GLAX recessed
RU Профиль LED GLAX врезной
UK Профіль GLAX врізний

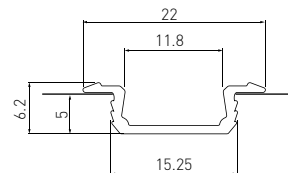

PA-GLAX-AL	2	profil, profile, профиль, профіль	srebrny, silver, серебристый, срібний	aluminium, aluminium, алюминий, алюміній	5901867111975	
PA-GLAX-AL-20M			czarny, black, черный, чорний		5902801256431	
PA-GLAX-AL-10			biały, white, белый, білий		5902801256691	
PA-GLAX-AL-90			szampan, champagne, шампань, шампань		5902801256639	
PA-GLAX3M-AL	3	profil, profile, профиль, профіль	srebrny, silver, серебристый, срібний	aluminium, aluminium, алюминий, алюміній	5901867196583	
PA-GLAX3M-AL-20M			czarny, black, черный, чорний		5902801308789	
PA-GLAX3M-AL-10			biały, white, белый, білий		5902801308932	
PA-OSMLGLAX-00	2	oslonka, cover, крышка, кришка	mleczna, frosted, молочная, молочний	PC	5901867111999	
PA-OSMLGLAX3M-00	3		transparentna, transparent, прозрачная, прозорий		5901867197610	
PA-OSTRGLAX-00	2		czarny, black, черный, чорний		5901867112002	
PA-OSTRGLAX3M-00	3				5901867197627	
PA-OSCLGLAX-00	2				5902801395161	
PA-OSCLGLAX3M-00	3				5902801395314	
PA-ZASGLAX-00	-	zaślepka, end cap, заглушка, кінцевий ковпачок	szary, gray, серый, сірий	ABS	5901867111982	
PA-ZASGLAX-10			biały, white, белый, білий		5902801245145	
PA-ZASGLAX-90			szampan, champagne, шампань, шампань		5902801245169	
PA-ZASGLAX-20M			czarny mat, black matt, чёрный матовый, чорний матовий		5902801244674	

Oslonki / Covers / Крышки / Кришки:

Zaślepka / End cap / Заглушка / кінцевий ковпачок:



PA-OSMLGLAX-00
PA-OSMLGLAX3M-00

PA-OSCLGLAX-00

PA-OSTRGLAX-00
PA-OSTRGLAX3M-00

PA-ZASGLAX-00

PL Profil GLAX wpuszczany, wysoki
EN Profile GLAX recessed, high
RU Профиль LED GLAX врезной, высокий
UK Профіль GLAX врізний, високий

Brak widocznych punktów świetlnych
Taśma LED max 10 mm szerokości
No visible points of light
LED strip width max 10 mm
Нет видимых точек света
Ширина светодиодной ленты не более 10 мм
Відсутність видимих світлових точок
Стрічка LED максимум 10 мм шириною.

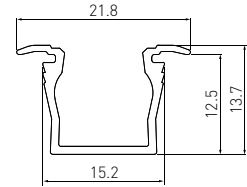

PA-GLAXMW-AL	2	profil, profile, профиль, профіль	srebrny, silver, серебристый, срібний	aluminium, aluminium, алюминий, алюміній	5902801027475
PA-GLAXMW-AL-20M			czarny, black, черный, чорний		5902801256967
PA-GLAXMW-AL-10			biały, white, белый, білий		5902801256622
PA-GLAXMW-AL-90			szampan, champagne, шампань, шампань		5902801257049
PA-OSCLGLAXM-00	2	osłonka mini, cover mini, крышка mini, кришка mini	czarny, black, черный, чорний	PC	5902801395437
PA-OSMLGLAXM-00			mleczna, frosted, молочная, молочный		5902801024023
PA-OSMLGLAXMK-00		osłonka kwadratowa, square cover, крышка квадратная, кришка квадратна			5902801040511
PA-OSTRGLAXM-00		osłonka mini, cover mini, крышка mini, кришка mini	transparentna, transparent, прозрачная, прозрачный		5902801024030
PA-ZASGLAXMW-00	-	zaślepka standard, standard end cap, заглушка стандартная, заглушка стандартная	szary, gray, серый, сірий	ABS	5902801040481
PA-ZASGLAXMW-10			biały, white, белый, білий		5902801241635
PA-ZASGLAXMW-90			szampan, champagne, шампань, шампань		5902801242090
PA-ZASGLAXMW-20M			czarny mat, black matt, чёрный матовый, чорний матовый		5902801241628
PA-ZASGLAXMWK-00	-	zaślepka kwadratowa, square end cap, заглушка квадратная, заглушка квадратна	szary, gray, серый, сірий		5902801040559

Oslonki / Covers / Крышки / Кришки:

Zaślepka / End cap / Заглушка / кінцевий ковпачок:



PA-OSMLGLAXM-00

PA-OSCLGLAXM-00

PA-OSTRGLAXM-00

PA-OSMLGLAXMK-00

PA-ZASGLAXMW-00

PA-ZASGLAXMWK-00

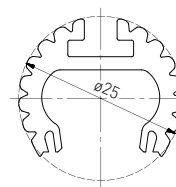

Możliwości montażu jako,
Assembly options as,
Варианты сборки как,
Можливість установки як

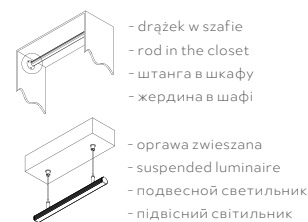

Folder	Length (m)	Info	Material	Color	Barcode
PA-GLAXDR-AL		profil, profile, профиль, профіль	srebrny, silver, серебристый, срібний	aluminium, aluminium, алюминий, алюміній	5902801258954
PA-OSMLGLAX-00	2	osłonka, cover, крышка, кришка	mleczna, frosted, молочная, молочный	PC	5901867111999
PA-OSTRGLAX-00			transparentna, transparent, прозрачная, прозорий		5901867112002
PA-ZASGLAXDR-00	-	zaślepka, end cap, заглушка, кінцевий ковпачок	szary, gray, серый, сірий		ZnAl
PA-ROZGLAX-53	-	rozetka, rail socket, монтажный крепеж, Розетка,		5902801018046	
PA-ROZGLAXP-53	-	rozetka PREMIUM, rail socket PREMIUM, монтажный крепеж PREMIUM, Розетка PREMIUM,		5902801226359	
PA-ZAWGLAXDR-00	1,5	zawieszka, hanger, подвес для профиля, підвіска	chrom, chrome, хром, хром	stal, steel, сталь, сталь	5902801046506

Ostonki / Covers / Крышки / Кришки:



PA-OSMLGLAX-00

PA-OSTRGLAX-00

Zaślepka / End cap / Заглушка / кінцевий ковпачок:



PA-ZASGLAXDR-00

Rozetka / Rail socket / Монтажный крепеж / Розетка:



PA-ROZGLAX-53

PA-ROZGLAXP-53

Zawieszka / Hanger / Подвес для профиля / Підвіска:



PA-ZAWGLAXDR-00

PL Profil GLAX z radiatorem
EN Profile GLAX with heatsink
RU Профиль GLAX радиатор
UK Профіль GLAX радіатор

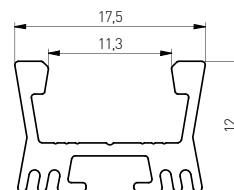

Dedykowana soczewka zawężająca kąt świecenia do 60°.
Możliwość zawieszenia oprawy za pomocą linek
Dedicated lens that narrows the beam angle to 60 degrees
Possibility to suspend the fixture using lines
Специальная линза, сужающая угол свечения до 60 градусов
Возможность монтажа с помощью крепления-тросика
Призначена линза, яка звужує кут освітлення до 60°.
Можливість підвішування світильника за допомогою кабелів

PA-GLAXRAD-AL	2	profil, profile, профиль, профіль	srebrny, silver, серебристый, срібний	aluminium, aluminium, алюминий, алюміній	5902801281877
PA-OSMLGLAXSO-00	2	osłonka soczewka, cover lenticular, крышка линза, кришка лінза	transparentna, transparent, прозрачная, прозорий	PMMA	5902801293153
PA-OSMLGLAX-00	2	osłonka, cover, крышка, кришка	mleczna, frosted, молочная, молочный	PC	5901867111999
PA-OSTRGLAX-00			transparentna, transparent, прозрачная, прозорий		5901867112002
PA-ZASGLAXRAD-00	-	zaślepka, end cap, заглушка, заглушка	szary, gray, серый, сірий	ABS	5902801200373
PA-ZAWGLAXDR-00	1,5	zawieszka, hanger, подвес для профиля, підвіска	chrom, chrome, хром, хром	stal, steel, сталь, сталь	5902801046506
PA-SPRGLAXM-00	-	uchwyt, mounting clip, клипса, клипса	srebrny, silver, серебристый, срібний	stal nierdzewna, stainless steel, нержавеющей сталь, нержавіюча сталь	5902801244711

Osłonki / Covers / Крышки / Кришки:



PA-OSMLGLAXSO-00

PA-OSMLGLAX-00

PA-OSTRGLAX-00

Uchwyt / mounting clip / держатель / монтажн клипса:



PA-SPRGLAXM-00

Zawieszka / Hanger / Подвес для профиля / Підвіска:



PA-ZAWGLAXDR-00

PL Profil GLAX wieńcowy
EN Rim profile GLAX
RU Профиль GLAX, торцевой
UK Профіль GLAX торцевий



White

Black

Silver

Champagne

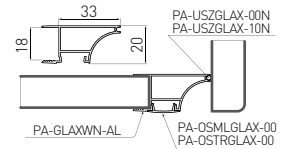

Folder	BOARD mm	L m	i	Material	Material	Barcode
PA-GLAXWN-AL	18	2	profil, profile, профиль, профіль	srebrny, silver, серебристый, срібний	aluminium, aluminium, алюминий, алюміній	5902801258619
PA-GLAXWN3M-AL				5902801363511		
PA-GLAXWN3M-AL-20M		3		czarny, black, черный, чорний		5902801363535
PA-GLAXWN3M-AL-10				biały, white, белый, білий		5902801363641
PA-GLAXWN3M-AL-06				inox, inox, шлифованная сталь, інокс		5902801363665
PA-GLAXWN16-AL	16	2	srebrny, silver, серебристый, срібний	5902801210969		
PA-GLAXWN19-AL	19		5902801210723			
PA-OSMLGLAX-00	-	2	osłonka, cover, крышка, кришка	mleczna, frosted, молочная, молочний	PC	5901867111999
PA-OSTRGLAX-00	-			transparentna, transparent, прозрачная, прозорий		5901867112002
PA-OSCLGLAX-00	-	czarny, black, черный, чорний		5902801395161		
PA-OSMLGLAX3M-00	-	mleczna, frosted, молочная, молочний		5901867197610		
PA-OSTRGLAX3M-00	-	transparentna, transparent, прозрачная, прозорий		5901867197627		
PA-OSCLGLAX3M-00	-	3	czarny, black, черный, чорний	5902801395314		
PA-USZGLAX-00N	-	10	uszczelka, cord gasket, уплотнитель, прокладка	czarny, black, черный, чорний	EPDM	5902801021039
PA-USZGLAX-10N	-			biały, white, белый, білий		5902801297502

Ostonki / Covers / Крышки / Кришки:

Uszczelka / Cord gasket / Уплотнитель / Прокладка:



PA-OSMLGLAX-00
PA-OSMLGLAX3M-00



PA-OSCLGLAX-00
PA-OSCLGLAX3M-00



PA-OSTRGLAX-00



PA-USZGLAX-00N



PA-USZGLAX-10N

PL Profil GLAX kątowy, nakładany
EN GLAX aluminium corner profile – surface mounted
RU Профиль LED GLAX угловой, накладной
UK Профіль LED GLAX кутовий, накладний

meble plus
2019
PRODUKT ROKU



- White
- Black
- Silver
- Champagne

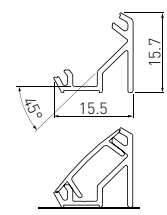

Icon: Folder	Icon: Length (m)	Icon: Information (i)	Icon: Recycle	Icon: Barcode	
PA-GLAXNKKT-AL	2	profil, profile, профиль, профіль	srebrny, silver, серебристый, срібний	aluminium, aluminium, алюминий, алюміній	5901867199089
PA-GLAXNKKT-AL-20M			czarny, black, черный, чорний		5902801256721
PA-GLAXNKKT-AL-10			biały, white, белый, білий		5902801259647
PA-GLAXNKKT-AL-90			szampan, champagne, шампань, шампань		5902801256868
PA-GLAXNKKT3M-AL	3	profil, profile, профиль, профіль	srebrny, silver, серебристый, срібний	aluminium, aluminium, алюминий, алюміній	5901867199072
PA-GLAXNKKT3M-AL-20M			czarny, black, черный, чорний		5902801308758
PA-GLAXNKKT3M-AL-10			biały, white, белый, білий		5902801308956
PA-OSMLGLAX-00	2	osłonka, cover, крышка, кришка	mleczna, frosted, молочная, молочний	PC	5901867111999
PA-OSMLGLAX3M-00	3		transparentna, transparent, прозрачная, прозрачный		5901867197610
PA-OSTRGLAX-00	2		czarny, black, черный, чорний		5901867112002
PA-OSTRGLAX3M-00	3				5901867197627
PA-OSCLGLAX-00	2		osłonka trójkątna, triangular cover, крышка треугольная, кришка трикутна		5902801395437
PA-OSCLGLAX3M-00	3				5902801395314
PA-OSMLGLAXT-00	2	osłonka trójkątna, triangular cover, крышка треугольная, кришка трикутна	mleczna, frosted, молочная, молочний	5902801040627	
PA-ZASGLAXNKKT-00	-	zaślepka standard, end cap standard, заглушка стандартная, заглушка стандартна	szary, gray, серый, сірий	ABS	5902801222900
PA-ZASGLAXNKKT-10			biały, white, белый, білий		5902801241734
PA-ZASGLAXNKKT-90			szampan, champagne, шампань, шампань		5902801245152
PA-ZASGLAXNKKT-20M			czarny mat, black matt, чёрный матовый, чорний матовий		5902801244476
PA-ZASGLAXNKKTT-00		zaślepka trójkątna, end cap triangular, заглушка треугольная, заглушка трикутна	szary, gray, серый, сірий		5902801223136
PA-SPRGLAXMIC-00	-	uchwyt, mounting clip, клипса, клипса	srebrny, silver, серебристый, срібний	stal nierdzewna, stainless steel, нержавеющая сталь, нержавіюча сталь	5902801244711

Oslonki / Covers / Крышки / Кришки:

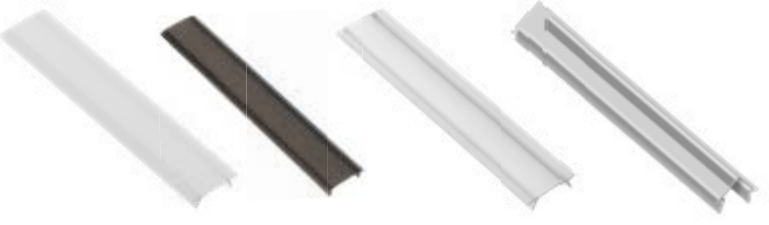

PA-OSMLGLAX-00 PA-OSMLGLAX3M-00 PA-OSCLGLAX-00 PA-OSCLGLAX3M-00 PA-OSTRGLAX-00 PA-OSTRGLAX3M-00 PA-OSMLGLAXT-00

Zaślepki / End caps / Заглушки / Кінцеві ковпачки:



PA-ZASGLAXNKKT-00 Uchwyt, mounting clip, держатель, клипса монтажна, PA-SPRGLAXMIC-00

PL Profil GLAX cokołowy wąski, dwustronny
 EN Corner profile GLAX, two-sided, edge mounted
 RU Профиль GLAX торцевой, узкий, накладной, двусторонний
 UK Профіль GLAX цокольний, вузький, двосторонній

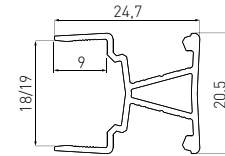

PA-GLAXMNBW3M-AL	18	3	profil, profile, профиль, профіль	srebrny, silver, серебристый, срібний	aluminium, aluminium, алюминий, алюміній	5902801259142
PA-GLAXMNBW3M19-AL	19					5902801281594
PA-OSMLGLAXM3M-00	-		oslonka mini, cover mini, крышка mini, кришка mini	mleczna, frosted, молочная, молочный	PC	5902801024054
PA-OSTRGLAXM3M-00	-		transparentna, transparent, прозрачная, прозорий	5902801024047		

Ostonki / Covers / Крышки / Кришки:



PA-OSMLGLAXM3M-00



PA-OSTRGLAXM3M-00

PL Profil GLAX cokołowy wąski, jednostronny
 EN Corner profile GLAX, one-sided, edge mounted
 RU Профиль GLAX торцевой, узкий, накладной, односторонний
 UK Профіль GLAX цокольний, вузький, односторонній

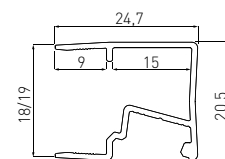

PA-GLAXMNBW3M-AL	18	3	profil, profile, профиль, профіль	srebrny, silver, серебристый, срібний	aluminium, aluminium, алюминий, алюміній	5902801259128
PA-GLAXMNBW3M19-AL	19					5902801281563
PA-OSMLGLAXM3M-00	-		oslonka, cover, крышка, кришка	mleczna, frosted, молочная, молочный	PC	5902801024054
PA-OSTRGLAXM3M-00	-			transparentna, transparent, прозрачная, прозорий		5902801024047

Ostonki / Covers / Крышки / Кришки:



PA-OSMLGLAXM3M-00



PA-OSTRGLAMX3M-00

PL Profil GLAX półkowy mini
EN Shelf profile GLAX mini
RU Профиль GLAX полочный мини
UK Профіль GLAX для полиць, міні

Możliwość zastosowania 3 taśm LED
Possibility of using 3 LED strips
Возможность использования 3 светодиодных лент
Можливість використання 3 стрічок LED

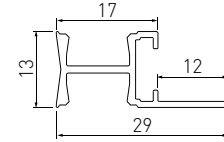
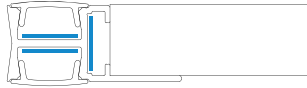

Folder	Length (m)	Info	RoHS	Recycling	Barcode
PA-GLAXMPK-AL	2	profil, profile, профиль, профіль	srebrny, silver, серебристый, срібний	aluminium, aluminium, алюминий, алюміній	5902801258633
PA-OSMLGLAXM-00		osłonka mini, cover mini, крышка mini, кришка mini	mleczna, frosted, молочная, молочный	PC	5902801024030
PA-OSTRGLAXM-00		transparentna, transparent, прозрачная, прозорий	5902801024023		

Ostonki / Covers / Крышки / Кришки:



PA-OSMLGLAXM-00



PA-OSTRGLAXM-00

PL Profil GLAX, z regulowanym kątem świecenia
EN Aluminium Profile LED with adjustable angle
RU Профиль LED GLAX с регулировкой угла свечения
UK Профіль GLAX з регулюванням кута світіння

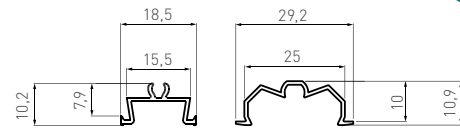

Folder	Length (m)	Info	RoHS	Recycling	Barcode
PA-GLAXREG1-AL	2	profil, profile, профиль, профіль	srebrny, silver, серебристый, срібний	aluminium, aluminium, алюминий, алюміній	5902801257773
PA-GLAXREG2-AL					5902801257797
PA-OSMLGLAX-00	2	osłonka mini, cover mini, крышка mini, кришка mini	mleczna, frosted, молочная, молочный	PC	5901867111999
PA-OSTRGLAX-00					transparentna, transparent, прозрачная, прозорий

Ostonki / Covers / Крышки / Кришки:



PA-OSMLGLAX-00



PA-OSTRGLAX-00

PL Profil GLAX cokolowy jednostronny
 EN GLAX aluminium edge profile – single-sided
 RU Профиль LED GLAX торцевой, односторонний
 UK Профіль GLAX цокольний, односторонній

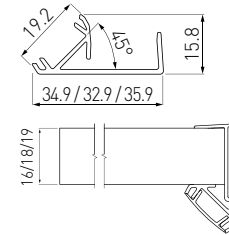

PA-GLAXNB3M16-AL	16	3	profil, profile, профиль, профіль	srebrny, silver, серебристый, срібний	aluminium, aluminium, алюминий, алюміній	5902801257834
PA-GLAXNB3M-AL	18	3				5902801258626
PA-GLAXNB3M19-AL	19	3				5902801257605
PA-OSMLGLAX3M-00	-	3	oslonka, cover, крышка, кришка	mleczna, frosted, молочная, молочний	PC	5901867197610
PA-OSTRGLAX3M-00	-	3		transparentna, transparent, прозрачная, прозорий		5901867197627

Ostonki / Covers / Крышки / Кришки:



PA-OSMLGLAX3M-00



PA-OSTRGLAX3M-00

PL Profil GLAX cokolowy jednostronny, do wypełnienia obrzeżem
 EN GLAX aluminium edge profile – single-sided, option to fill with matching edge banding
 RU Профиль LED GLAX торцевой, односторонний, кромочный
 UK Профіль GLAX цокольний, односторонній, для заповнення крайкою

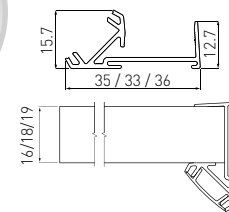

PA-GLAXNB3M16-AL	16	3	profil, profile, профиль, профіль	srebrny, silver, серебристый, срібний	aluminium, aluminium, алюминий, алюміній	5902801259036
PA-GLAXNB3M-AL	18	3				5902801258657
PA-GLAXNB3M19-AL	19	3				5902801258978
PA-OSMLGLAX3M-00	-	3	oslonka, cover, крышка, кришка	mleczna, frosted, молочная, молочний	PC	5901867197610
PA-OSTRGLAX3M-00	-	3		transparentna, transparent, прозрачная, прозорий		5901867197627

Ostonki / Covers / Крышки / Кришки:



PA-OSMLGLAX3M-00



PA-OSTRGLAX3M-00

PL Profil GLAX przegrodowy dwustronny
 EN GLAX aluminium edge profile – double sided
 RU Профиль LED GLAX разделительный, двухсторонний
 UK Профіль GLAX перегородковий, двосторонній

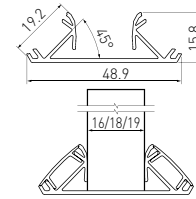

PA-GLAXNBD3M16-AL	16	3	profil, profile, профиль, профіль	srebrny, silver, серебристый, срібний	aluminium, aluminium, алюминий, алюміній	5902801259012
PA-GLAXNBD3M18-AL	18	3				5902801258640
PA-GLAXNBD3M19-AL	19	3				5902801257650
PA-OSMLGLAX3M-00	-	3	oslonka, cover, крышка, кришка	mleczna, frosted, молочная, молочный	PC	5901867197610
PA-OSTRGLAX3M-00	-	3		transparentna, transparent, прозрачная, прозорий		5901867197627

Oslonki / Covers / Крышки / Кришки:



PA-OSMLGLAX3M-00



PA-OSTRGLAX3M-00

PL Profil GLAX przegrodowy dwustronny, do wypełnienia obrzeżem
 EN GLAX aluminium edge profile – double sided, option to fill with matching edge banding
 RU Профиль LED GLAX разделительный, кромочный, двухсторонний
 UK Профіль GLAX перегородковий, двосторонній, для заповнення крайкою

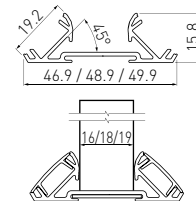

PA-GLAXNBDW3M16-AL	16	3	profil, profile, профиль, профіль	srebrny, silver, серебристый, срібний	aluminium, aluminium, алюминий, алюміній	5902801259050
PA-GLAXNBDW3M18-AL	18	3				5902801258664
PA-GLAXNBDW3M19-AL	19	3				5902801257803
PA-OSMLGLAX3M-00	-	3	oslonka, cover, крышка, кришка	mleczna, frosted, молочная, молочный	PC	5901867197610
PA-OSTRGLAX3M-00	-			transparentna, transparent, прозрачная, прозорий		5901867197627

Oslonki / Covers / Крышки / Кришки:



PA-OSMLGLAX3M-00



PA-OSTRGLAX3M-00

PL Profil GLAX kątowy
EN GLAX corner profile
RU Профиль GLAX угловой
UK Профіль GLAX кутовий



Code	Quantity	Description	Material	Material	Barcode
PA-GLAXKT-AL	2	profil, profile, профиль, профіль	srebrny, silver, серебристый, срібний	aluminium, aluminium, алюминий, алюміній	5901867127020
PA-GLAXKT3M-AL	3				5901867196590
PA-OSMLGLAX-00	2	oslonka, cover, крышка, кришка	mleczna, frosted, молочная, молочный	PC	5901867111999
PA-OSMLGLAX3M-00	3				5901867197610
PA-OSTRGLAX-00	3		transparentna, transparent, прозрачная, прозрачный		5901867112002
PA-OSTRGLAX3M-00	2				5901867197627
PA-ZASGLAXKT-00	-	zaślepka, end cap, заглушка, заглушка	szary, gray, серый, сірий	ABS	5901867136428

Ostonki / Covers / Крышки / Кришки:

Zaślepka / End cap / Заглушка / кінцевий ковпачок:



PL Profil GLAX kątowy, wpuszczany
EN Recessed corner profile GLAX
RU Профиль GLAX угловой, врезной
UK Профіль LED GLAX кутовий, врізний



PA-GLAXWPKT-AL
PA-OSMLGLAX-00
PA-OSTRGLAX-00

Kąt świecenia 22°
Beam angle 22°
Угол свечения 22°
Кут освітлення 22°

Code	Quantity	Description	Material	Material	Barcode
PA-GLAXWPKT-AL	2	profil, profile, профиль, профіль	srebrny, silver, серебристый, срібний	aluminium, aluminium, алюминий, алюміній	5902801257742
PA-OSMLGLAX-00		oslonka, cover, крышка, кришка	mleczna, frosted, молочная, молочный	PC	5901867111999
PA-OSTRGLAX-00			transparentna, transparent, прозрачная, прозрачный		5901867112002

Ostonki / Covers / Крышки / Кришки:

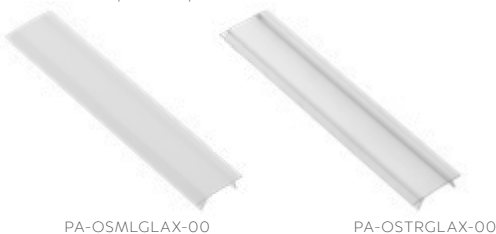

PL Zestaw GLAX wpuszczany
EN GLAX recessed - kit
RU Комплект профиль GLAX врезной
UK Комплект профіль GLAX врізний



White

Black

Silver

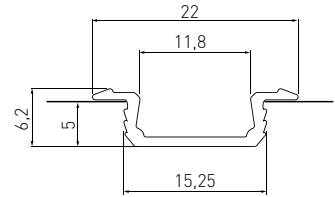

PA-ZGLAXOMZ-00	2	srebrny, silver, серебристый, срібний	aluminium, PC mleczne, ABS; aluminium, PC frosted, ABS; алюминий, PC молочная, ABS; алюміній, PC молочний, ABS	5902801255748
PA-ZGLAXOMZ-20M		czarny, black, черный, чорний		5902801386640
PA-ZGLAXOMZ-10		biały, white, белый, білий		5902801387128

PL Zestaw GLAX nakładany mini
EN GLAX profile mini surface mounted - kit
RU Комплект профиль GLAX накладной, мини
UK Комплект профіль GLAX накладний, міні



White

Black



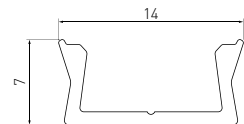

Silver

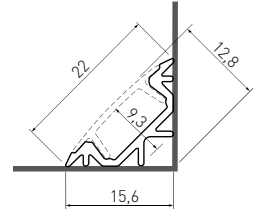

PA-ZGLAXMNKOMZ-00	2	srebrny, silver, серебристый, срібний	aluminium, PC mleczne, ABS; aluminium, PC frosted, ABS; алюминий, PC молочная, ABS; алюміній, PC молочний, ABS	5902801255885
PA-ZGLAXMNKOMZ-20M		czarny, black, черный, чорний		5902801386176
PA-ZGLAXMNKOMZ-10		biały, white, белый, білий		5902801386503

PL Zestaw GLAX kątowy
EN GLAX corner profile - kit
RU Комплект профиль GLAX угловой
UK Комплект профіль GLAX кутовий



				
PA-ZGLAXKTOMZ-00	2	srebrny, silver, серебристый, срібний	aluminium, PC mleczne, ABS; aluminium, PC frosted, ABS; алюминий, PC молочная, ABS; алюміній, PC молочний, ABS	5902801255892



PL Zestaw GLAX kątowy, nakładany
EN GLAX aluminium corner profile – surface mounted – kit
RU Комплект профиль LED GLAX угловой, накладной
UK Комплект профіль LED GLAX кутовий, накладний

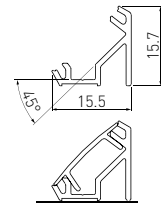

White

Black



				
PA-ZGLAXNKKTOMZ-20M	2	czarny, black, черный, чорний	aluminium, PC mleczne, ABS; aluminium, PC frosted, ABS; алюминий, PC молочная, ABS; алюміній, PC молочний, ABS	5902801386343
PA-ZGLAXNKKTOMZ-10		biały, white, белый, білий		5902801386572



BODY LOTION
SOUL-CHEATMEY & LINE
ABSORBS QUICKLY

SHAVE CREAM

Hand Cream

[orange and grapefruit]

100% organic oil
for the entire family

www.meraki-shop.de

PURE OIL

SHAVE CREAM

[best of]

Contains organic rosemary with a
cleansing and moisturizing effect

www.meraki-shop.de

BODY LOTION

BODY LOTION





OPRAWY LED
LED FIXTURES
СВЕТОДИОДНЫЕ СВЕТИЛЬНИКИ
СВІТЛОДИОДНІ СВЕТИЛЬНИКИ

PL Oprawa nakładana / wpuszczana
 EN Fixture surface mounted / recessed
 RU Светильник накладной / врезной
 UK Світлодіодний світильник накладний / врізний

VASCO



360°

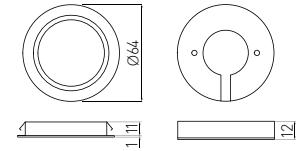

LD-VA24CB-53	130 lm	● 3000 K	aluminium, aluminium, алюминий, алюміній	tworzywo, plastic, пластик, пластик	5908231382627
LD-VA24NE-53		● 4000 K			5908231382641



PL Oprawa LED
 EN LED fixture
 RU Светильник LED
 UK Світлодіодний світильник

LUMINO

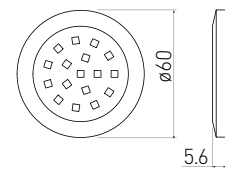

LD-LU16CB-53	85 lm	● 2700 K	aluminium, aluminium, алюминий, алюміній	tworzywo, plastic, пластик, пластик	5901867164742
LD-LU16NE-53		● 4000 K			5901867160874
LD-LU16ZB-53		● 6500 K			5901867160850



PL Oprawa LED z włącznikiem
EN LED fixture with switch
RU Светильник LED с выключателем
UK Світлодіодний світильник з вимикачем

CASTELLO

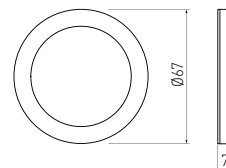

Folder	Light	Color	Material	Material	Barcode
LD-CS36CB-53	180 lm	● 3000 K	aluminium, aluminium, алюминий, алюміній	tworzywo, plastic, пластик, пластик	5908231382597
LD-CS36NE-53		● 4000 K			5908231382603
LD-CS36ZB-53		● 6200 K			5908231382610

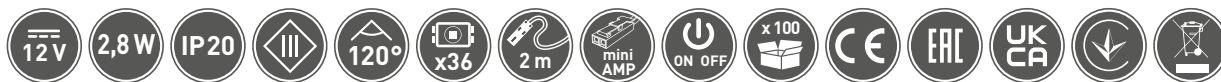

PL Oprawa LED wpuszczana
EN Recessed LED fixture
RU Светодиодный светильник врезной
UK Світлодіодний світильник врізний

ALVARO

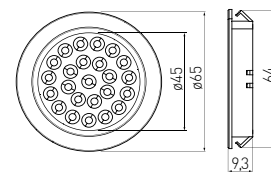

Folder	Light	Color	Material	Material	Barcode
LD-AL24CB-53	130 lm	● 3000 K	aluminium, aluminium, алюминий, алюміній	tworzywo, plastic, пластик, пластик	5901867156976
LD-AL24NE-53		● 4000 K			5901867156969
LD-AL24ZB-53		● 6400 K			5901867156952



PL Oprawa LED
EN LED fixture
RU Светильник LED
UK Світлодіодний світильник

VEGAS

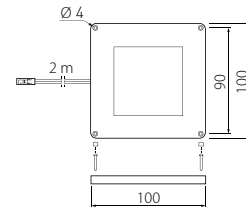

LD-VE15CB-53N	140 lm	● 3000 K	aluminium, aluminium, алюминий, алюміній	tworzywo, aluminium plastic, aluminium пластмасса, алюминий пластик, алюминій	5902801236655
LD-VE15NE-53N	145 lm	● 4000 K			5902801236730
LD-VE15ZB-53N	150 lm	● 6400 K			5902801235610



PL Oprawa 2 w 1
EN Fixture 2 in 1
RU Светильник 2 в 1
UK Світильник 2 в 1

VEGAS

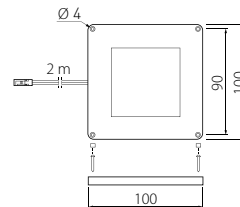

Powiązane produkty:
Włącznik dotykowy bezprzewodowy CCT
AE-WDBP2CCT-10N, AE-WDBP2CCT-20N

Related products:
Wireless touchless switch CCT
AE-WDBP2CCT-10N, AE-WDBP2CCT-20N

Связанных с ними продуктов:
Беспроводной сенсорный выключатель CCT
AE-WDBP2CCT-10N, AE-WDBP2CCT-20N

Пов'язані продукти:
Бездротовий сенсорний вимикач CCT
AE-WDBP2CCT-10N, AE-WDBP2CCT-20N



LD-VE15CBZB-53N	140 lm	● 3000 K - ● 6400 K	aluminium, aluminium, алюминий, алюміній	tworzywo, aluminium plastic, aluminium пластмасса, алюминий пластик, алюминій	5902801235627



TREVI

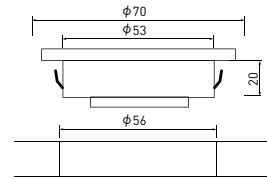

Folder	Light	Color	Material	Material	Barcode
LD-TR24CB-53	300 lm	3000 K	aluminium, aluminium, алюминий, алюминій	tworzywo, plastic, пластик, пластик	5902801032905
LD-TR24NE-53	220 lm	4000 K			5902801298950
LD-TR24ZB-53	300 lm	6400 K			5902801032998



PL Zestaw opraw z włącznikiem
EN Fixture kit with switch
RU Комплект светильников с выключателем
UK Набір світильників з вимикачем

CASTELLO

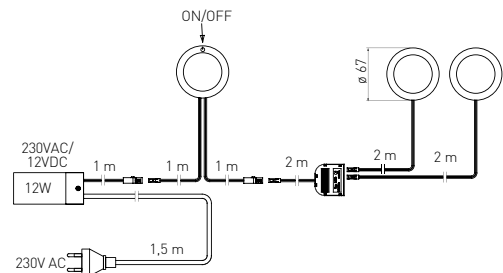

Folder	Light	Color	Material	Material	Barcode
LD-Z3CSCB-53	3 x 180 lm	3000 K	aluminium, aluminium, алюминий, алюминій	tworzywo, plastic, пластик, пластик	5908231389251



PL Zestaw opraw
EN Fixture kit
RU Комплект светильников
UK Набір світильників

BARRI

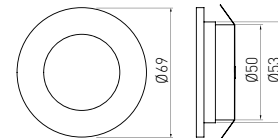

LD-OBP27CB-53	3 x 80 lm	● 2700 K	aluminium, aluminium, алюминий, алюміній	tworzywo, aluminium plastic, aluminium пластмасса, алюминий пластик, алюминій	5908231374127
LD-OBP27ZB-53		● 6400 K			5908231374134



PL Zestaw opraw
EN Fixture kit
RU Комплект светильников
UK Набір світильників

MARBELLA

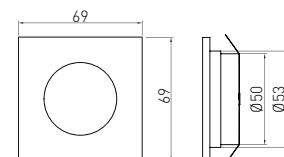

LD-KWP27CB-53	3 x 80 lm	● 2700 K	aluminium, aluminium, алюминий, алюміній	tworzywo, aluminium plastic, aluminium пластмасса, алюминий пластик, алюминій	5908231374103



PL Oprawa na wyciągniku
EN Fixture with arm
RU Светильник типа „дуга”
UK Світлодіодний світильник на консолі

RADIUS II



LD-RA60CB-40N	220 lm	● 3000 K	chrom, chrome, хром, хром	tworzywo, plastic, пластик, пластик	5902801231070
LD-RA60ZB-40N		● 6000 K			5902801234699



PL Oprawa LED bezprzewodowa
EN Cordless LED fixture
RU Светодиодный светильник беспроводной
UK Світильник бездротовий

COMA



LD-IRUSB-53

LD-PIRUSB-53

Przewód USB (do ładowania) - 0,5 m w komplecie
Additional 0,5m USB cable (for charging)
Дополнительный кабель USB (для зарядки) - 0,5 м
Провід USB (для зарядки) - 0,5 м в комплекті

			INFO			
LD-IRUSB-53	40-50 lm	● 4000 K	Czujnik zbliżeniowy IR, jedno- lub dwu-biegowy, Proximity sensor IR, single or double-pole, Датчик движения IR, одно- и многофункциональный, Сенсор IR, одно або двофункційний	aluminium, aluminium, алюминий, алюміній	stal, tworzywo steel, plastic сталь, пластмасса сталь, пластик	5901867188182
LD-PIRUSB-53			Czujnik ruchu PIR, jednobiegowy, Proximity sensor IR, single-pole, Датчик движения PIR, однофункциональный, Сенсор руху PIR, однофункційний			5901867188199



PL Lampka
EN Lamp
RU Лампа
UK Лампа

BOSTON

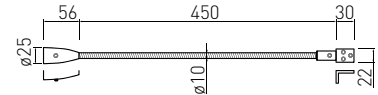

Wymaga zasilacza 12 V, 6 W
Requires 12 V, 6 W power supply
Требуется блок питания 12 В, 6 Вт
Вимагає блоку живлення 12 В, 6 Вт

LD-BOS1CBWG-53	90 lm	3000 K	aluminium, aluminium, алюминий, алюміній	stal, tworzywo, aluminium steel, plastic, aluminium сталь, пластмасса, алюминий сталь, пластик, алюміній	5902801002915



PL Klip LED do półek
EN LED clip for shelves
RU Клипса LED для стеклянных полок
UK Кліпс світлодіодний для полиці



LD-KLPCB-00N
LD-KLPNB-00N
LD-KLPZB-00N



LD-3SKL-ZBN

LD-KLPCB-00N	10 lm	3000 K	tworzywo, plastic, пластик, пластик	5901867188205
LD-KLPNB-00N	-	niebieski, blue, синий, синій		5901867173997
LD-KLPZB-00N	12 lm	6400 K		5901867187734
LD-3SKL-ZBN	12 lm	6400 K	stal, steel, сталь, сталь	5901867175212



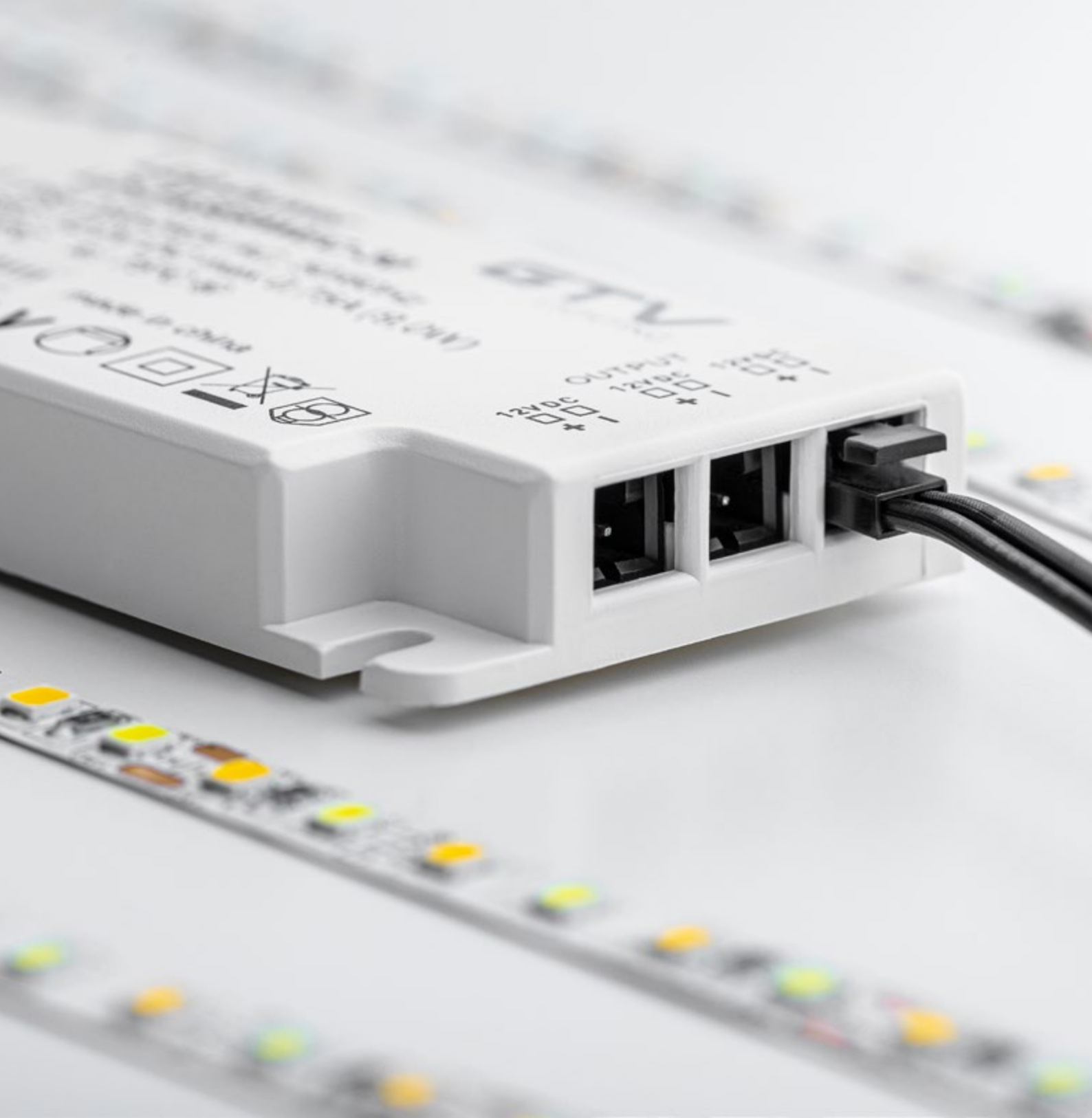

AKCESORIA
ACCESSORIES
AKCECCYAPY
AKCECYAPИ

PL Zasilacz LED EASY CLICK
 EN LED power supply EASY CLICK
 RU Блок питания LED EASY CLICK
 UK Блок живлення LED EASY CLICK

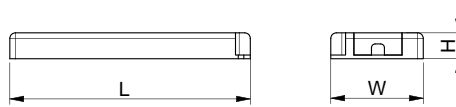

	max	i	A	LxWxH mm			
LD-ZAS09WEC-30	9 W	3 miniAMP	0,75 A	103 x 41 x 12mm	tworzywo, plastic, plastik, пластик	110 g	5902801360664
LD-ZAS15WEC-30	15 W	4 miniAMP	1,25 A	129 x 42 x 16 mm		130 g	5902801361876
LD-ZAS20WEC-30	20 W		1,67 A	129 x 42 x 16 mm		140 g	5902801369872
LD-ZAS30WEC-30	30 W	6 miniAMP	2,5 A	160 x 50 x 18 mm		190 g	5902801370038
LD-ZAS60WEC-30	60 W		5 A	190 x 62 x 21 mm		290 g	5902801369995



PL Zasilacz LED
EN LED power supplies
RU Блоки питания LED
UK Блок живлення LED

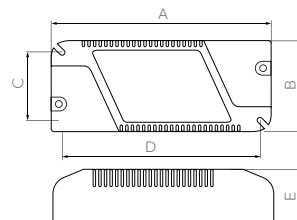

LD-ZAS75W-30	max 75 W	180 x 52 x 42 x 176 x 30	tworzywo, plastic, пластик, пластик	350 g	5901867141477



PL Zasilacz LED 24V
EN LED power supplies 24V
RU Блоки питания LED 24V
UK Блок живлення LED 24V

NEW

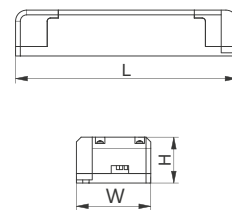

LD-ZAS24PRO80W-30	80 W	181 x 63 x 40 mm	tworzywo, plastic, пластик, пластик	300 g	5902801237409
LD-ZAS24PRO16W-30	16 W				5902801367120
LD-ZAS24PRO33W-30	33 W				5902801327179
LD-ZAS24PRO54W-30	54 W				5902801327186



PL Układ zasilający
EN LED power supplies
RU Система электропитания
UK Система електроживлення

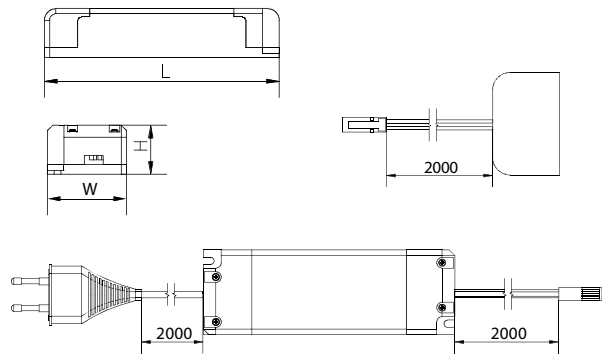

LD-ZZAS07PROKD6		7 W	100 x 39 x 25	tworzywo, plastic, пластик, пластик	5902801246180
LD-ZZAS12PROKD6		12 W	120 x 42 x 27		5902801246364
LD-ZZAS16PROKD6		16 W	120 x 42 x 27		5902801245848
LD-ZZAS24PROKD6		24 W	140 x 47 x 29		5902801246203
LD-ZZAS33PROKD6		33 W	155 x 53 x 30		5902801231087



PL Zasilacz LED PRO
EN LED PRO power supplies
RU Блоки питания LED PRO
UK Блок живлення LED PRO

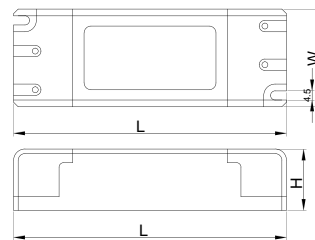

LD-ZASPRO07W-30		7 W	100 x 39 x 25 mm	tworzywo, plastic, пластик, пластик	56g	5902801208331
LD-ZASPRO12W-30		12 W	120 x 42 x 27 mm		82 g	5902801207952
LD-ZASPRO16W-30		16 W	120 x 42 x 27 mm		82 g	5902801207983
LD-ZASPRO24W-30		24 W	140 x 47 x 29 mm		109 g	5902801208270
LD-ZASPRO33W-30		33 W	140 x 47 x 29 mm		150 g	5902801251702
LD-ZASPRO54W-30		54 W	155 x 53 x 30 mm		173 g	5902801207976
LD-ZASPRO65W-30		65 W	181 x 63 x 40 mm		281 g	5902801207969
LD-ZASPRO80W-30		80 W	181 x 63 x 40 mm		290g	5902801208010



PL Zasilacz LED
EN LED power supplies
RU Блоки питания LED
UK Блок живлення LED

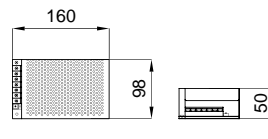

LD-ZAS150-NW	max 150 W	160 x 98 x 50	aluminium, aluminium, алюміній, алюміній	347 g	5901867128829



PL Zasilacz LED
EN LED power supplies
RU Блоки питания LED
UK Блок живлення LED

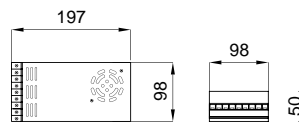

LD-ZAS350-NW	max 350 W	197 x 98 x 50	aluminium, aluminium, алюміній, алюміній	589 g	5901867128843



PL Zasilacze LED
EN LED power supply units
RU Блоки питания LED
UK Блоки живлення LED

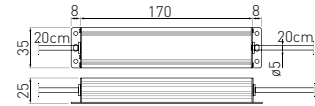

LD-WZA20W-NW

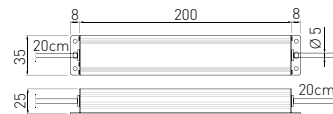

LD-WZA36W-NW

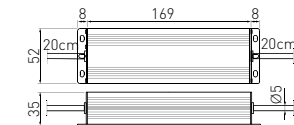

LD-WZA60W-NW



LD-WZA80W-NW

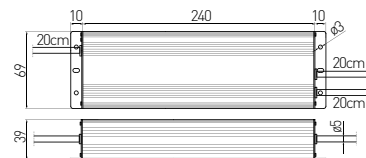

LD-WZA150W-NW

LD-WZA20W-NW	20 W	170 g	5901867128720
LD-WZA36W-NW	36 W	310 g	5901867128744
LD-WZA60W-NW	60 W	990 g	5901867128768
LD-WZA80W-NW	80 W	1000 g	5901867128782
LD-WZA150W-NW	150 W	2000 g	5901867128805



PL Zasilacz LED puszkowy
EN LED power supply
RU Блок питания LED
UK Блок живлення коробковий

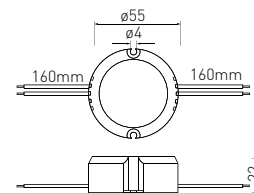

LD-ZASPU15W-30N	15 W	tworzywo, plastic, пластик, пластик	5902801020094



PL Układ zasilający do klipów LED
 EN Power feeder set for LED clips
 RU Блок питания для светодиодных клипс
 UK Система електроживлення для світлодіодних кліпс

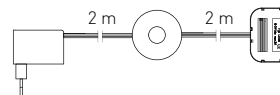

LD-ZSKL15-00N	5 x mini AMP	tworzywo, plastic, пластик, пластик	5902801270970
LD-ZZASG18KWD6	6 x mini AMP		5902801294884



PL Układ zasilający
 EN Power feeder set
 RU Блок питания для светодиодных клипс, 5 разъёмов
 UK Система електроживлення для 5-точкових світлодіодних кліпс

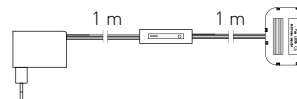

LD-ZWND6W-10	max 6 W	tworzywo, plastic, пластик, пластик	5908231335753
LD-ZWND12-10	max 12 W		5908231336675



PL Zestaw RGB - kontroler, zasilacz LED 6W, pilot i dystrybutor
 EN RGB kit - RGB controller, power supply, remote control and distributor
 RU Комплект RGB – контролер, трансформатор 6W, пульт, дистрибьютор
 UK Набір RGB, контролер, світлодіодний блок живлення 6Вт, пульт і розподільник



LD-ZAC6WDE-RGB	RGB	tworzywo, plastic, пластик, пластик	5908231399663



PL Kontroler RGB mini z pilotem
 EN Mini RGB controller with remote control
 RU Миниконтроллер RGB с пультом
 UK Світлодіодний контролер RGB з міні-пультом



LD-KONMINI-RGB	RGB	tworzywo, plastic, пластмасса, Блок пластик	5908231384676



PL Kontroler 1-strefowy MONO
EN 1-zone controller MONO
RU 1-зонный контроллер MONO
UK Контролер 1-зонний MONO

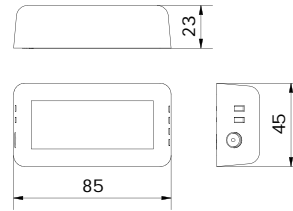

LD-KONML-MONO	MONO	tworzywo, plastic, пластик, пластик	5902801200151
---------------	------	-------------------------------------	---------------



PL Pilot 4-strefowy MONO
EN 4-zone remote controller MONO
RU 4-зонный пульт дистанционного управления MONO
UK 4-зонний пульт дистанційного керування MONO

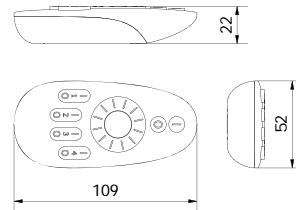

LD-KONML-MONO-PIL	tworzywo, plastic, пластик, пластик	5902801200502
-------------------	-------------------------------------	---------------



PL Panel dotykowy 4-strefowy na baterie MONO
EN Battery powered 4-zone touch panel MONO
RU 4-зонная сенсорная панель с батарейками MONO
UK 4-зонна сенсорна панель з батарейками MONO

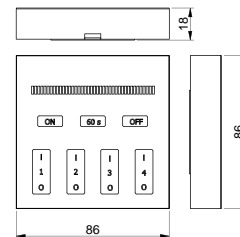

LD-KONML-MONO-PAN	tworzywo, plastic, пластик, пластик	5902801200571
-------------------	-------------------------------------	---------------



PL Kontroler 1-strefowy RGBW
EN 1-zone controller RGBW
RU 1-зонный контроллер RGBW
UK Контролер 1-зонний RGBW

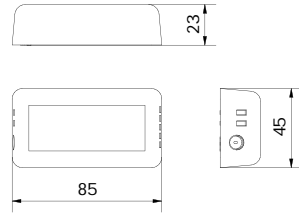

LD-KONML-RGBW	RGBW	tworzywo, plastic, пластик, пластик	5902801200519
---------------	------	-------------------------------------	---------------



PL Pilot 4-strefowy RGBW
EN 4-zone remote controller RGBW
RU 4-зонный пульт дистанционного управления RGBW
UK 4-зонний пульт дистанційного керування RGBW

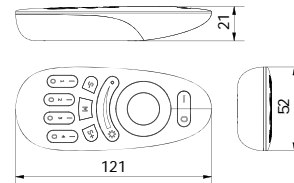

LD-KONML-RGBW-PIL	RGBW	tworzywo, plastic, пластик, пластик	5902801200380
-------------------	------	-------------------------------------	---------------



PL Panel dotykowy 4-strefowy na baterie RGBW
EN Battery powered 4-zone touch panel RGBW
RU 4-зонная сенсорная панель с батарейками RGBW
UK 4-зонна сенсорна панель з батарейками RGBW

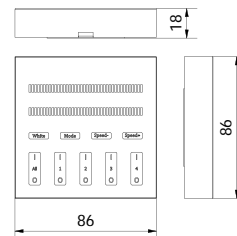

LD-KONML-WRGB-PAN	RGBW	tworzywo, plastic, пластик, пластик	5902801200489
-------------------	------	-------------------------------------	---------------



PL Kontroler WiFi
EN WiFi-Controller
RU WiFi - контроллер
UK WiFi - контролер

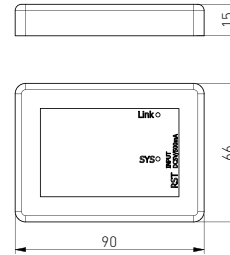

LD-KONML-WIFI	RGB	tworzywo, plastic, пластик, пластик	5902801200588
---------------	-----	-------------------------------------	---------------



PL Adapter do pilota
EN Remote control adapter
RU Адаптер пульта дистанционного управления
UK Адаптер пульта дистанційного керування

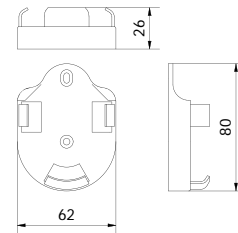

LD-KONML-AD	biały, white, белый, білий	tworzywo, plastic, пластик, пластик	5902801200700
-------------	----------------------------	-------------------------------------	---------------



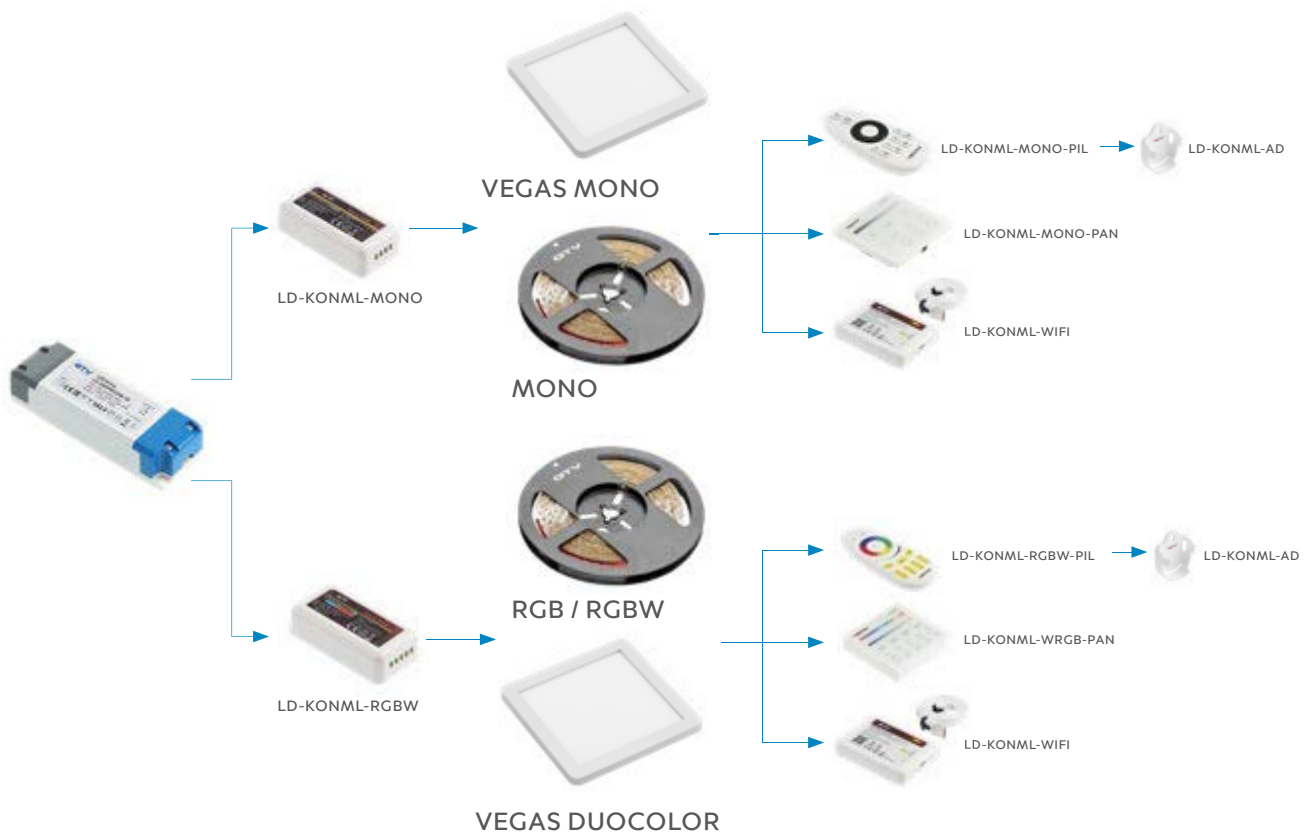

PL Włącznik dotykowy bezprzewodowy on-off
 EN Wireless touchless switch on-off
 RU Беспроводной сенсорный выключатель on-off
 UK Бездротовий сенсорний вимикач on-off



White

Black

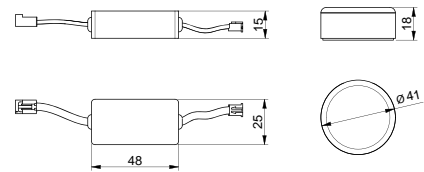

AE-WDBP1-10 N	biały, white, белый, білий	tworzywo, plastic, пластик, пластик	5902801330919
AE-WDBP1-20 N	czarny, black, черный, чорний		5902801330926



PL Włącznik dotykowy bezprzewodowy CCT
 EN Wireless touchless switch CCT
 RU Беспроводной сенсорный выключатель CCT
 UK Бездротовий сенсорний вимикач CCT

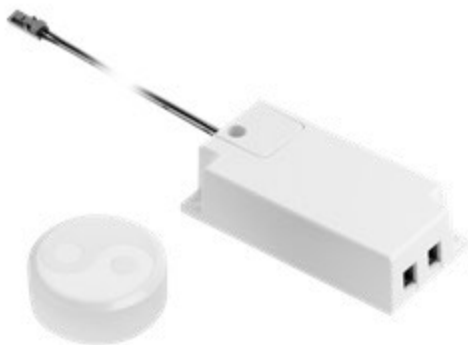

White

Black

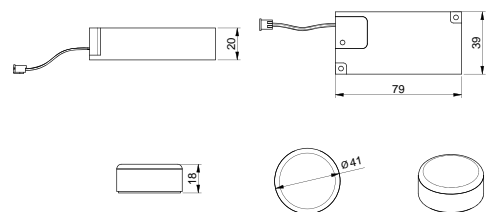

AE-WDBP2CCT-10N	biały, white, белый, білий	tworzywo, plastic, пластик, пластик	5902801330971
AE-WDBP2CCT-20N	czarny, black, черный, чорний		5902801331107





PL Włącznik bezdotykowy
EN Touchless switch
RU Бесконтактный выключатель
UK Безконтактний вимикач

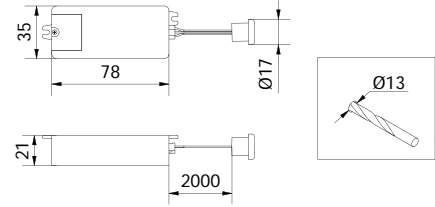

INFO



AE-WBEZDC-10S	dwubiegowy two-pole двухрежимный дворежимный	tworzywo, plastic, пластик, пластик	5901867160348
AE-WBEZDB-10S*	jednobiegowy single-pole однорежимный однорежимный		5901867160324



PL Włącznik dotykowy pod śrubę
EN Touch switch for a screw
RU Сенсорный выключатель под винт
UK Сенсорний вимикач під гвинт

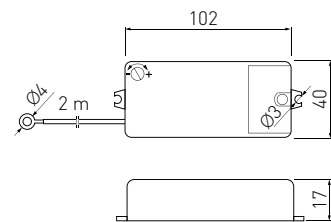

AE-WBEZDK15-10	tworzywo, plastic, пластик, пластик	5902801032110
----------------	-------------------------------------	---------------



PL Włącznik z czujnikiem ruchu PIR
 EN Switch with PIR motion detector
 RU Выключатель с датчиком движения PIR
 UK Вимикач з датчиком руху PIR

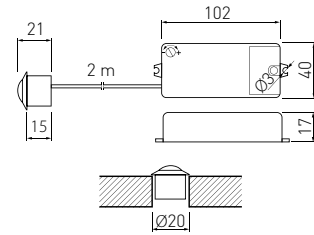

AE-WBEZDPIR-10	tworzywo, plastic, пластик, пластик	5902801032141
----------------	-------------------------------------	---------------



PL Włącznik z dwoma sensorami ruchu PIR II
 EN Switch with two PIR II motion sensors
 RU Выключатель с двумя датчиками движения PIR II
 UK Вимикач з двома датчиками руху PIR II

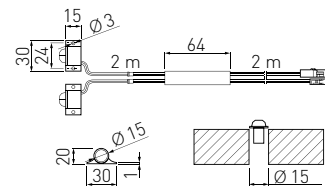

AE-WBEZDPIR2-20	tworzywo, plastic, пластик, пластик	5902801032639
-----------------	-------------------------------------	---------------



PL Włącznik bezdotykowy uniwersalny 3 w 1
 EN 3 in 1 all-purpose touchless switch
 RU Бесконтактный выключатель 3 в 1
 UK Безконтактний вимикач універсальний 3 в 1



White

Black

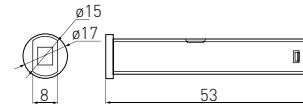

AE-WBBUNI-10DIM	biały, white, белый, білий	tworzywo, plastic, пластик, пластик	5901867158338
AE-WBCUNI-10DIM	czarny, black, черный, чорний		5901867158352



PL Włącznik bezdotykowy, mikro
 EN Touchless switch, micro
 RU Бесконтактный выключатель, микро
 UK Безконтактний вимикач, мікро

NEW

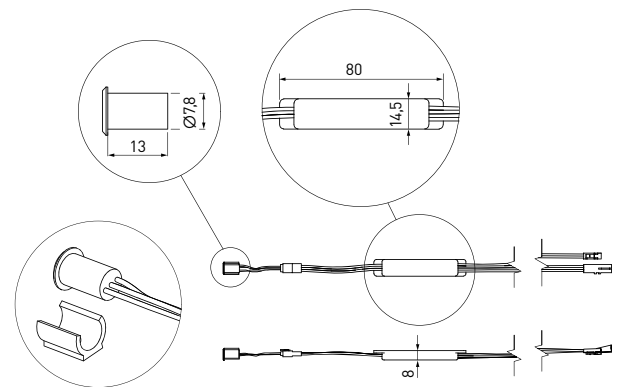

AE-WBE1-20	czarny, black, черный, чорний	tworzywo, plastic, пластик, пластик	5902801458859
AE-WBE1-10	biały, white, белый, білий		5902801458835

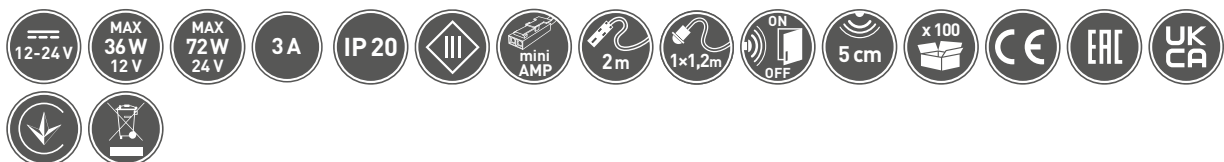

PL Włącznik bezdotykowy, mikro
 EN Touchless switch, micro
 RU Бесконтактный выключатель, микро
 UK Безконтактний вимикач, мікро

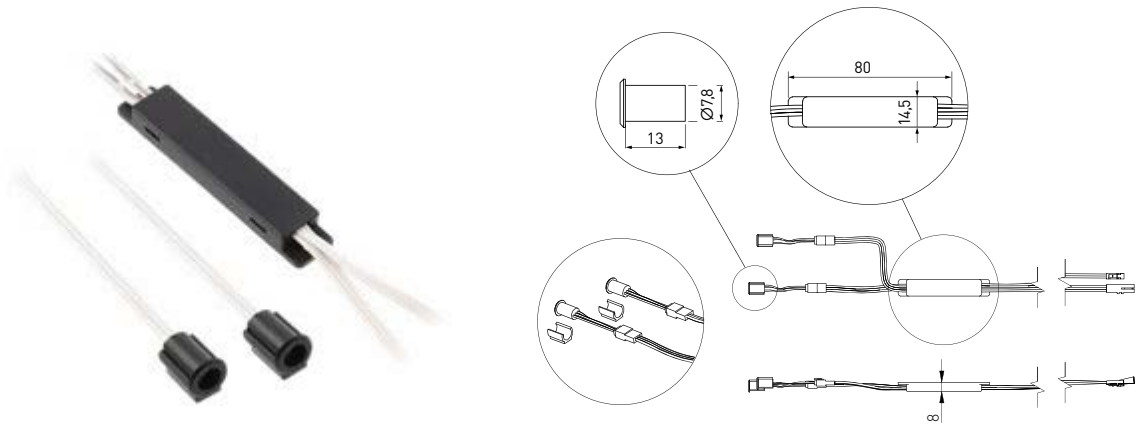

AE-WBE2-20	czarny, black, черный, чорний	tworzywo, plastic, пластик, пластик	5902801458682
AE-WBE2-10	biały, white, белый, білий		5902801458644



PL Włącznik dotykowy ściemniający
 EN Dimmable touch switch
 RU Выключатель с регулятором яркости
 UK Сенсорний вимикач з диммером



White

Black

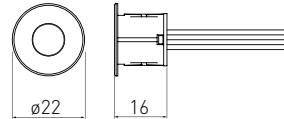

AE-WDSB-10DIM	biały, white, белый, білий	tworzywo, plastic, пластик, пластик	5901867175724
AE-WDSC-10DIM	czarny, black, черный, чорний		5901867175748



PL Włącznik dotykowy ściemniający
EN Dimmable touch switch
RU Выключатель с регулятором яркости
UK Сенсорний вимикач з диммером



AE-WBEZD-NBN	chrom, chrome, хром, хром	tworzywo, plastic, пластик, пластик	5902801367069



PL Włącznik podblatowy
EN Countertop switch
RU Выключатель под столешницу
UK Вимикач під стільницю

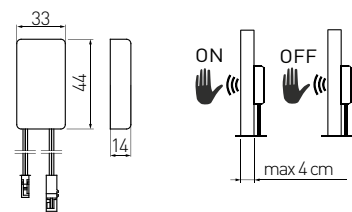

Grubość blatu max 40 mm
Countertop thickness max 40 mm
Толщина столешницы макс. 40 мм
Товщина поверхні максимум 40 мм

AE-WPDRW-00	tworzywo, plastic, пластик, пластик	5901867127167



PL Włącznik do taśm LED montowany w profil
 EN Switch for LED strips mounted in profile
 RU Выключатель для ленты LED
 UK Вимикач для світлодіодних стрічок, що встановлюється в профілі

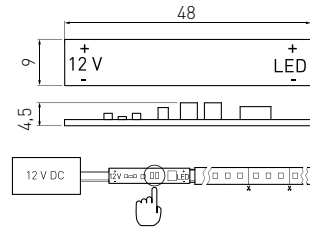

AE-WLPR-60	-	biały, white, белый, білий	plytka elektroniczna circuit board электронная плата електронна панель	1000	5908231398284
AE-WLPR-60P2	2 m			500	5902801022005



PL Włącznik kotykowski
 EN Button switch
 RU Выключатель кнопочный
 UK Вимикач кнопочний

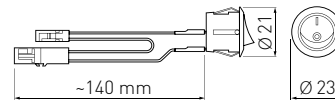

AE-WLB01-10	biały, white, белый, білий	tworzywo, plastic, пластик, пластик	5902801004346
AE-WLC01-20	czarny, black, черный, чорний		5902801004322



PL Przełącznik kołyskowy okrągły
EN Round rocker switch
RU Выключатель клавишный круглый
UK Вимикач кнопковий круглий



AE-WLIP44-15	biały, white, белый, білий.	tworzywo, plastic, пластмасса, пластик	5901867125071
--------------	-----------------------------	--	---------------



PL Ściemniacz LED
EN LED dimmer
RU Светодиодный диммер
UK Світлодіодний диммер

JACKY

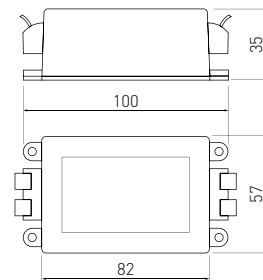

LD-DIMLED-10	czarny, black, черный, чорний	PC	800 g	5908231337597
--------------	-------------------------------	----	-------	---------------



PL Włącznik łańcuszkowy
EN Pull chain switch
RU Цепной выключатель
UK Ланцюговий вимикач



AE-WLLAN1-10	chrom, chrome, хром, хром	tworzywo, plastic, пластик, пластик	5908231313942
AE-WLLAN1-90	złoty, gold, золотой, золотий		5901867124548
AE-WLLAN1-20	czarny, black, черный, чорний		5901867124531



PL Włącznik sznurkowy
EN Pull cable switch
RU Шнурочный выключатель
UK Дротовий вимикач



AE-WLSZN1-10	czarny, black, черный, чорний	polipropylen, polypropylene, полипропилен, полипропилен.	590823133186



PL Kabel zasilający z wtyczką i włącznikiem
 EN Cable with plug and switch
 RU Кабель с вилкой и выключателем
 UK Кабель живлення з вилкою і вимикачем

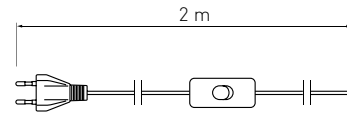

LD-KABE2M-00	biały, white, белый, білий	tworzywo, plastic, пластик, пластик	5908231335265



PL Przewód ze złączką mini AMP
 EN Cable with Mini AMP
 RU Кабель с соединителем mini AMP
 UK Провід з конектором mini AMP

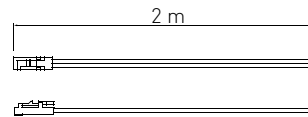

LZ-KA2MM-10	czarny, black, черный, чорний	tworzywo, plastic, пластик, пластик, пластик	5901867174161



PL Przewód ze złączkami mini AMP
 EN Cable with Mini AMP
 RU Кабель с соединителями mini AMP
 UK Провід з конекторами mini AMP

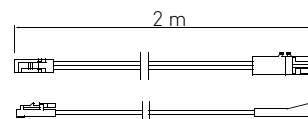

LZ-KAPR2M-10	czarny, black, черный, чорний	tworzywo, plastic, пластик, пластик	5908231335876



PL Złączka do oświetlenia ledowego z dystrybutorem, 3 gniazda
 EN LED fixtures connector with distributor, 3 sockets
 RU Соединитель LED с распределителем, 3 гнезда
 UK Роз'єм для світлодіодного освітлення з розподільником, 3 гнізда

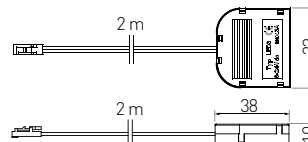

LZ-AKZ312-10N	czarny, black, черный, чорний	tworzywo, plastic, пластик, пластик	5901867174017



PL Złączka do oświetlenia ledowego z dystrybutorem, 6 gniazd
 EN LED fixtures connector with distributor, 6 sockets
 RU Соединитель LED с распределителем, 6 гнезд
 UK Роз'єм для світлодіодного освітлення з розподільником, 6 гнізд

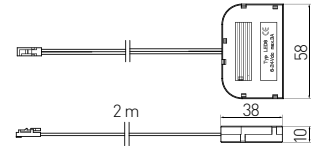

LZ-AKZ612-10N	czarny, black, черный, чорний	tworzywo, plastic, пластик, пластик	5901867187598
---------------	-------------------------------	-------------------------------------	---------------



PL Złączka do taśm LED COB
 EN Connector for COB LED strips
 RU Соединитель для лент LED COB
 UK Роз'єм для світлодіодних стрічок COB

NEW

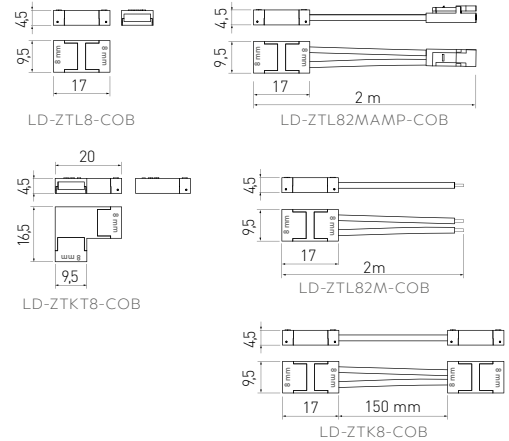

LD-ZTL82MAMP-COB	tworzywo, plastic, пластик, пластик	5902801456138
LD-ZTL82M-COB		5902801454325
LD-ZTL8-COB		5902801455612
LD-ZTK8-COB		5902801455841



PL Złączka XC11 do taśm LED
 EN Connector XC11 for LED strips
 RU Соединитель XC11 для лент LED
 UK Роз'єм XC11 для світлодіодних стрічок



LD-ZTL8MM-02N, LD-ZTL8MM-02N600

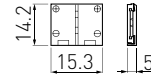

LD-ZTL10MM-02N, LD-ZTLRGB-04N



INFO



LD-ZTL8MM-02N600	8 mm / 600 LED	tworzywo, plastic, пластик, пластик	5902801001536
LD-ZTL10MM-02N	10 mm		5901867172587
LD-ZTLRGB-04N	RGB		5901867172617



PL Złączka XC11 do taśm LED kątowna
 EN Angular connector XC11 for LED strips
 RU Угловой соединитель XC11 для лент LED
 UK Роз'єм XC11 для світлодіодних стрічок кутовий

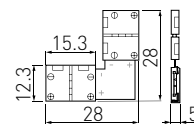

LD-ZTKT8MM-02N, LD-ZTKT8MM-02N600

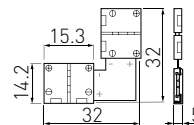

LD-ZTKTRGB-04N



INFO



LD-ZTKT8MM-02N600	8 mm / 600 LED	tworzywo, plastic, пластик, пластик	5902801001550
LD-ZTKT10MM-02N	10 mm		5901867172884
LD-ZTKTRGB-04N	RGB		5901867172822



PL Złącza XC11 do taśm LED z przewodem 15 cm
 EN Connector XC11 with 15 cm cord, for strips
 RU Соединитель XC11 для лент LED, с проводом 15 см
 UK Роз'єм XC11 для світлодіодних стрічок з кабелем 15 см

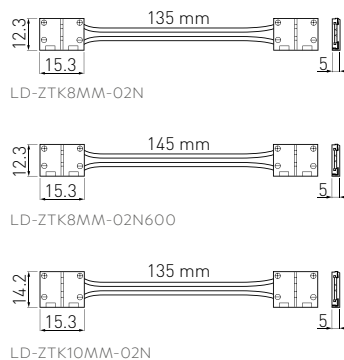

	INFO		
LD-ZTK8MM-02N600	8 mm / 600 LED	tworzywo, plastic, пластик, пластик	5902801001543
LD-ZTK10MM-02N	10 mm		5901867172761



PL Złącza XC11 do taśm LED SLIM
 EN Connector XC11 for LED strips SLIM
 RU Соединитель XC11 для лент LED SLIM
 UK Роз'єм XC11 для світлодіодних стрічок SLIM

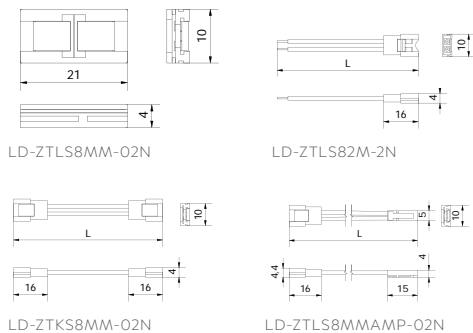

	INFO		
LD-ZTLS8MM-02N	8 mm	-	5902801202377
LD-ZTKS8MM-02N		15 cm	5902801202230
LD-ZTLS82M-2N		200 cm	5902801202391
LD-ZTLS8MMAMP-02N		200 cm + mini amp	5902801205392



PL Ładowarka bezprzewodowa LUX z zasilaczem
 EN Inductive charger with a power feeder LUX
 RU Зарядное устройство индукционное с блоком питания LUX
 UK Зарядний пристрій індукційний з блоком живлення LUX

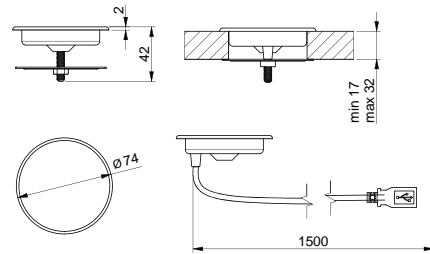

AE-ZLADLUX-40	chrom, chrome, хром, хром	tworzywo, plastic, пластик, пластик	5902801235153
---------------	---------------------------	-------------------------------------	---------------



PL Ładowarka bezprzewodowa / indukcyjna, podblatowa z zasilaczem
 EN Wireless surface charger, under the countertop mount
 RU Беспроводное зарядное устройство, под столешницу
 UK Бездротовий зарядний пристрій під стільницю з блоком живлення

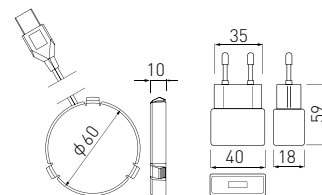

AE-ZLADPOD-20	czarny, black, черный, чорний	tworzywo, plastic, пластик, пластик	5902801031854
---------------	-------------------------------	-------------------------------------	---------------



PL Ładowarka indukcyjna z zasilaczem
 EN Wireless charger with power supply
 RU Беспроводное зарядное устройство с блоком питания
 UK Зарядний пристрій індукційний з блоком живлення

360°

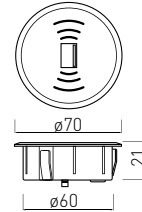

AE-ZUSB-20	czarny, black, черный, чорний	tworzywo, plastic, пластик, пластик	5901867181954
------------	-------------------------------	-------------------------------------	---------------





GNIAZDA MEBLOWE
POWER SOCKETS
УДЛИНИТЕЛИ
ПОДОВЖУВАЧІ

PL Gniazdo meblowe wpuszczane
 EN Recessed power socket
 RU Мебельный удлинитель врезной
 UK Меблевий подовжувач врізний

PRESTINO



AE-PB2FPRES-10



AE-PB2FPRES-20



AE-PB2FPRES-53



AE-PB2SPRES-10



AE-PB2SPRES-20



AE-PB2SPRES-53

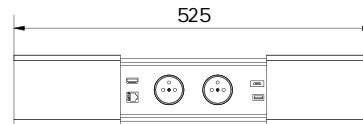
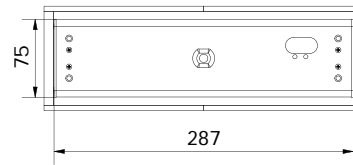
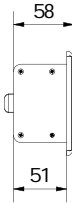
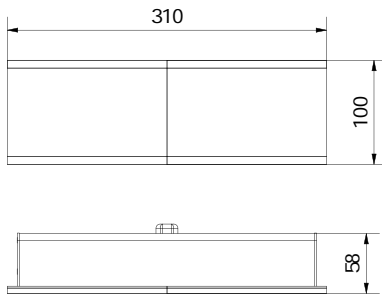

INFO



AE-PB2FPRES-20	USB-A + USB-C DC5V 3A (max 15,0W) DC9V 2A (MAX. 18,0W) DC12V 1.5A (MAX. 18,0W)	2 x french	aluminium, aluminium, алюминий, алюминій	aluminium tworzywo, aluminium plastic, алюминий пластик, алюминій пластик	5902801349812
AE-PB2SPRES-20		2 x schuko			5902801349669
AE-PB2FPRES-53		2 x french			5902801355301
AE-PB2SPRES-53		2 x schuko			5902801349829
AE-PB2FPRES-10		2 x french			5902801355295
AE-PB2SPRES-10		2 x schuko			5902801325601



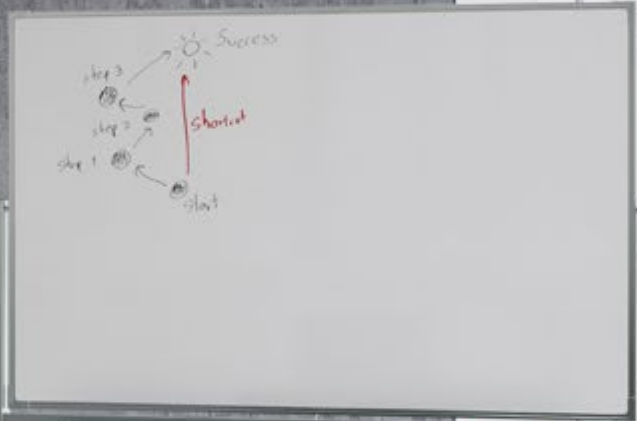

PL Gniazdo meblowe wpuszczane
 EN Recessed power socket
 RU Мебельный удлинитель врезной
 UK Меблевий подовжувач врізний

CHARGER PLUS



AE-BPW1FACP-10



AE-BPW1SACP-10

White

Black

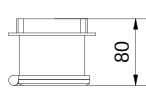
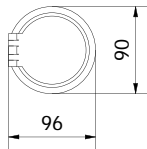

Included



White

Black

Folder	INFO	X	RoHS	Stack	Barcode
AE-BPW1FACP-10	USB A+C 5V/2,4A interchangeable: USB A, HDMI, RJ45	1 x french	biały, white, белый, білий	tworzywo, plastic, пластик	5902801325489
AE-BPW1FACP-20		1 x french	czarny, black, черный, чорний		5902801354977
AE-BPW1SACP-10		1 x schuko	biały, white, белый, білий		5902801325519
AE-BPW1SACP-20		1 x schuko	czarny, black, черный, чорний		5902801355332







COMFORT PLUS



AE-BPW4F120P-10



AE-BPW4S120P-10

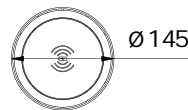
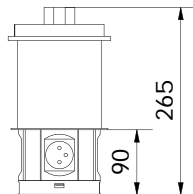

INFO



AE-BPW4F120P-10	2xUSB 5V/3,1A 2xRJ45	4 x french	biały, white, белый, білий	tworzywo, plastic, пластик, пластик	5902801355172
AE-BPW4F120P-20			czarny, black, черный, чорний		5902801355288
AE-BPW4S120P-10		4 x schuko	biały, white, белый, білий		5902801355264
AE-BPW4S120P-20			czarny, black, черный, чорний		5902801354878







CAMINO



AE-BPW2FCAM-20



AE-BPW2FCAM-10

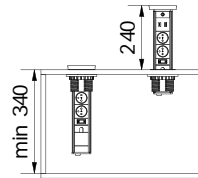
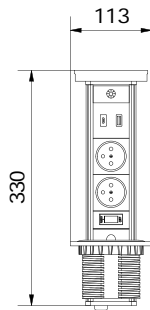

INFO



AE-BPW2FCAM-20	USB-A + USB-C DC5V 3A (max 15,0W) DC9V 2A (MAX. 18,0W) DC12V 1.5A (MAX. 18,0W)	2 x french	czarny, black, черный, чорний	aluminium tworzywo, aluminium plastic, алюміній пластик, алюминій пластик	5902801325410
AE-BPW2SCAM-20		2 x schuko			5902801355233
AE-BPW2FCAM-10		2 x french	biały, white, белый, білий		5902801325533
AE-BPW2SCAM-10		2 x schuko			5902801325656





PL Gniazdo meblowe wpuszczane
 EN Recessed power socket
 RU Мебельный удлинитель врезной
 UK Меблевий подовжувач врізний

AVARO PLUS



AE-PB1FAVAP-10

AE-PB1SAVAP-10

White

Black

Grey

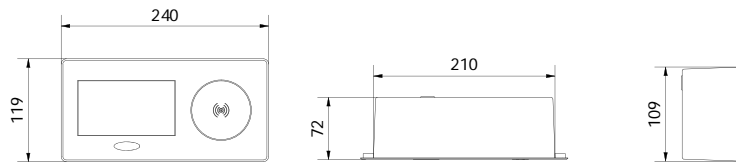

	INFO	X			
AE-PB1FAVAP-20	USB-A + USB-C DC5V 3A (max 15,0W) DC9V 2A (MAX. 18,0W) DC12V 1.5A (MAX. 18,0W)	1 x french	czarny, black, черный, чорний	aluminium tworzywo, aluminium plastic, алюміній пластик, алюміній пластик	5902801325137
AE-PB1SAVAP-20		1 x schuko			5902801355349
AE-PB1FAVAP-53		1 x french	szary, gray, серый, сірий		5902801325786
AE-PB1SAVAP-53		1 x schuko			5902801326172
AE-PB1FAVAP-10		1 x french	biały, white, белый, білий		5902801355196
AE-PB1SAVAP-10		1 x schuko			5902801325540





AVARO



AE-PB1FAVA-10



AE-PB1SAVA-10

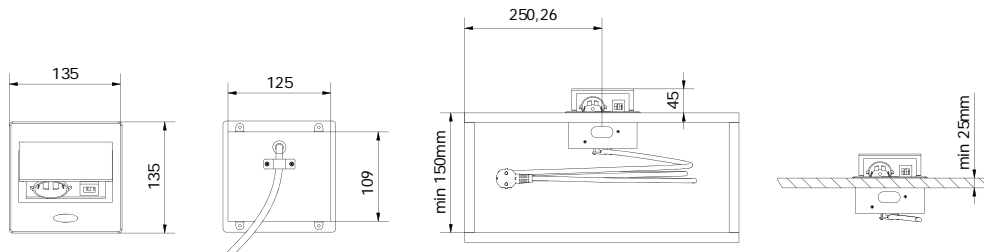

	INFO	X			
AE-PB1FAVA-20	USB A DC5V 2A (MAX. 10,0W)	1 x french	czarny, black, черный, чорний	aluminium tworzywo, aluminium plastic, алюминий пластик, алюміній пластик	5902801355165
AE-PB1SAVA-20		1 x schuko			5902801349706
AE-PB1FAVA-53		1 x french	szary, gray, серый, сірий		5902801355271
AE-PB1SAVA-53		1 x schuko			5902801349713
AE-PB1FAVA-10		1 x french	biały, white, белый, білий		5902801355202
AE-PB1SAVA-10		1 x schuko			5902801355189





PL Gniazdo meblowe wpuszczane
 EN Recessed power socket
 RU Мебельный удлинитель врезной
 UK Меблевий подовжувач врізний

CHARGER

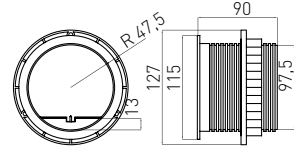

AE-BPW1S2UCH-80	1 x schuko	srebrny, silver, серебряный, срібний	tworzywo, plastic, пластик, пластик	5901867196439
AE-BPW1U2UCH-80	1 x french			5901867196422



PL Gniazdo meblowe wpuszczane
 EN Recessed power socket
 RU Мебельный удлинитель врезной
 UK Меблевий подовжувач врізний

CHARGER MINI



AE-BPW1S1UCH-53

AE-BPW1U1UCH-53

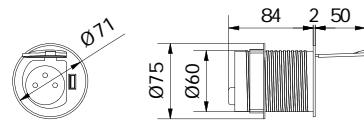

AE-BPW1U1UCH-53	1 x french	aluminium, aluminium, алюминий, алюміній	tworzywo, plastic, пластик, пластик	5902801253065
AE-BPW1S1UCH-53	1 x schuko			5902801253713



PL Gniazdo meblowe wpuszczane
EN Recessed power socket
RU Мебельный удлинитель врезной
UK Меблевий подовжувач врізний

SLIDE



AE-BPW1U1UCH-51

AE-BPW1S1UCH-51

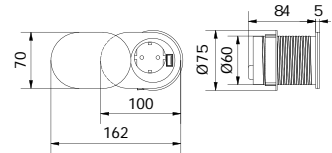

INFO



AE-BPW1U1UCH-51	USB 5V / 2,4A	1 x french	aluminium, aluminium, алюминий, алюміній	tworzywo, plastic, пластик, пластик	5902801253027
AE-BPW1S1UCH-51		1 x schuko			5902801252945



PL Gniazdo meblowe wpuszczane
EN Recessed power socket
RU Мебельный удлинитель врезной
UK Меблевий подовжувач врізний

COMFORT



AE-BPW3S100U-53

AE-BPW4U100-53

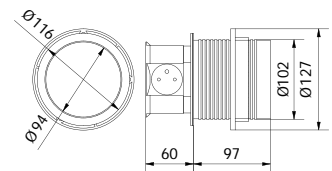

INFO



AE-BPW4U100-53	USB 5V / 2,4A	4 x french	aluminium, aluminium, алюминий, алюміній	aluminium tworzywo, aluminium plastic, алюміній пластик, алюміній пластик	5902801252617
AE-BPW4S100-53		4 x schuko			5902801253003
AE-BPW3U100U-53		3 x french			5902801253010
AE-BPW3S100U-53		3 x schuko			5902801252587



PL Gniazdo meblowe wpuszczane okrągłe ø 100
 EN Мебельный удлинитель врезной круглый ø 100
 RU Мебельный удлинитель врезной круглый ø 100
 UK Меблевий подовжувач врізний круглий ø 100



Black

Silver

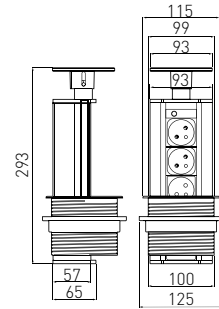

AE-BPW3GU-20	100	3 x french	czarny, black, черный, чорний	aluminium tworzywo, aluminium plastic, алюміній пластик, алюміній пластик	5908231338815
AE-BPW3GU-80			srebrny, silver, серебряный, срібний		5908231338808
AE-BPW3GS-20		3 x schuko	czarny, black, черный, чорний		5908231338839
AE-BPW3GS-80			srebrny, silver, серебряный, срібний		5908231338822

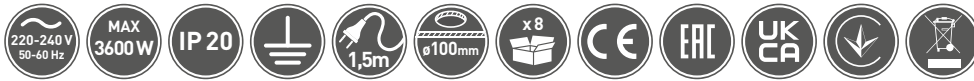

PL Gniazdo meblowe wpuszczane okrągłe ø 60
 EN Round recessed power socket ø 60
 RU Мебельный удлинитель врезной круглый ø 60
 UK Меблевий подовжувач врізний круглий ø 60



Black

Silver

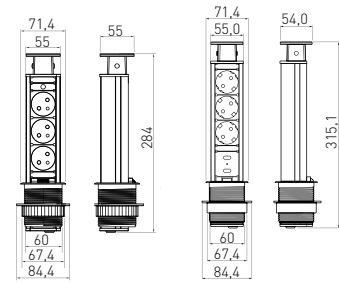

AE-BPW3U60U-20

AE-BPW3U60-80



AE-BPW3U60-20	60	3 x french	-	czarny, black, черный, чорний	aluminium tworzywo, aluminium plastic, алюміній пластик, алюміній пластик	5908231395559	
AE-BPW3U60-80				srebrny, silver, серебряный, срібний		5908231395566	
AE-BPW3S60-20		3 x schuko		czarny, black, черный, чорний		5908231395535	
AE-BPW3S60-80				srebrny, silver, серебряный, срібний		5908231395542	
AE-BPW3U60U-20		5V USB		3 x french		czarny, black, черный, чорний	5901867130983
AE-BPW3U60U-80						srebrny, silver, серебряный, срібний	5901867131003
AE-BPW3S60U-20				3 x schuko		czarny, black, черный, чорний	5901867130945
AE-BPW3S60U-80						srebrny, silver, серебряный, срібний	5901867130969



PL Gniazdo meblowe wpuszczane prostokątne
EN Rectangular recessed power socket
RU Мебельный удлинитель врезной
UK Меблевий подовжувач врізний

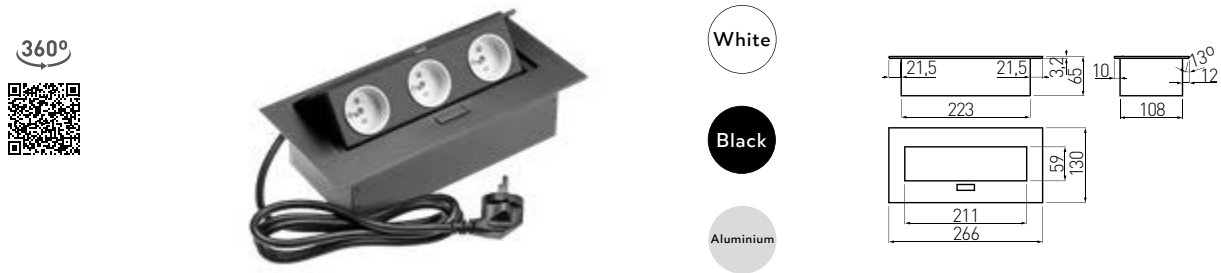

AE-PB03GS-53	-	3 x schuko	aluminium, aluminium, алюминий, алюміній	stal, tworzywo steel, plastic сталь, пластмасса сталь, пластик	5908231362605
AE-PB03GS-20	-	3 x schuko			5901867157089
AE-PB03GS-10	-	3 x schuko			5901867157096
AE-PB03GU-53	-	3 x french			5908231337689
AE-PBC3GU-53	1,5 m	3 x french	5908231389121		
AE-PBC3GU-20	1,5 m	3 x french	czarny, black, черный, чорний		5902801023385
AE-PBC3GU-10	1,5 m	3 x french	biały, white, белый, білий		5901867130730



PL Gniazdo meblowe wpuszczane prostokątne
EN Rectangular recessed power socket
RU Мебельный удлинитель врезной
UK Меблевий подовжувач врізний



AE-PBU02GS-10	2 x schuko	biały, white, белый, білий	stal, tworzywo steel, plastic сталь, пластмасса сталь, пластик	5901867157072
AE-PBU02GS-20		czarny, black, черный, чорний		5901867157065
AE-PBU2GU-10	2 x french	biały, white, белый, білий		5901867131010
AE-PBU2GU-20		czarny, black, черный, чорний		5901867131034
AE-PBU2GU-53		aluminium, aluminium, алюминий, алюміній		5902801265723



PL Gniazdo meblowe wpuszczane
EN Recessed power socket
RU Мебельный удлинитель врезной
UK Меблевий подовжувач врізний

SOFT



White

Black

Aluminium

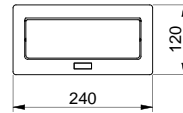

AE-PBSC3GS-10	3 x schuko	-	biały, white, белый, білий	stal, tworzywo steel, plastic сталь, пластмасса сталь, пластик	5902801252129
AE-PBSC3GS-20N			czarny, black, черный, чорний		5902801281730
AE-PBSC3GS-53			aluminium, aluminium, алюминий, алюміній		5902801252167
AE-PBSC3GU-10	3 x french	-	biały, white, белый, білий		5902801252242
AE-PBSC3GU-20N			czarny, black, черный, чорний		5902801281716
AE-PBSC3GU-53			aluminium, aluminium, алюминий, алюміній		5902801251955
AE-PBSUC2GS-10	2 x schuko	5V USB max 2A	biały, white, белый, білий		5902801252259
AE-PBSUC2GS-20N			czarny, black, черный, чорний		5902801281693
AE-PBSUC2GS-53			aluminium, aluminium, алюминий, алюміній		5902801252235
AE-PBSUC2GU-10	2 x french	-	biały, white, белый, білий	5902801252440	
AE-PBSUC2GU-20N			czarny, black, черный, чорний	5902801281761	
AE-PBSUC2GU-53			aluminium, aluminium, алюминий, алюміній	5902801252815	





PL Gniazdo meblowe przepustowe z USB
 EN Through-desk power socket with USB
 RU Мебельный удлинитель проходной с USB
 UK Меблевий подовжувач врізний прохідний з USB

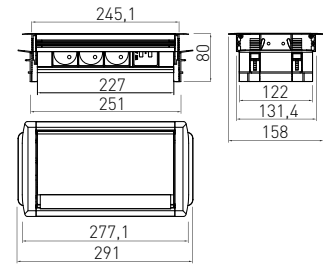

AE-PBC3GS-53BKS	3 x schuko	-	aluminium, aluminium, алюминий, алюміній	aluminium tworzywo, aluminium plastic, алюминий пластик, алюміній пластик	5901867196637
AE-PBC3GS2U-53BKS	3 x schuko	5V USB max 2A			5901867196651



PL Gniazdo meblowe bez kasety
 EN Furniture power socket without housing
 RU Мебельный удлинитель без корпуса
 UK Меблевий подовжувач без корпусу

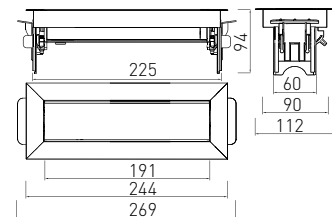

AE-PBC3GS-51BK	3 x schuko	stal szcztkowana brushed steel шлифованная сталь	stal, aluminium, tworzywo steel, aluminium, plastic	5901867196613
AE-PBC3GU-51BK	3 x french	матована сталь	сталь, алюминий, пластмасса сталь, алюминий, пластик	5901867196620



PL Gniazdo meblowe kątowe
 EN Corner furniture power socket
 RU Мебельный удлинитель угловой
 UK Меблевий подовжувач кутювий

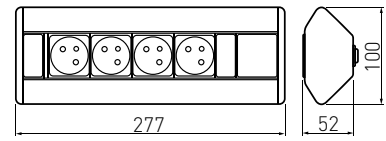

AE-PBKT4S-80

























AE-PBKT3U2U-80

AE-PBKT4U-80	4 x french	-	5V USB max 2A	srebrny, silver, серебряный, срібний	aluminium tworzywo, aluminium plastic, алюминий пластик, алюміній пластик	5901867162779
AE-PBKT4S-80	4 x schuko					5901867162786
AE-PBKT3U2U-80	3 x french	5901867162793				
AE-PBKT3S2U-80	3 x schuko	5901867162809				



Przewodnik po symbolach katalogu | Guide to catalog symbols | Условные обозначения Умовні позначення в каталозі

Ikony elektrotechniczne | Electrical engineering icons | Электротехнические иконки | Іконки електротехнічні

	Odpowiednik mocy Wattage equivalent Эквивалент мощности Еквівалент потужності		Kąt świecenia Beam angle Угол свечения Кут світіння
	Prąd znamionowy Rated current Номинальный ток Номинальний струм		Stopień ochrony IP International protection marking Пылевлагозащита IP Ступінь захисту IP
	Moc źródła światła lub urządzenia Light source or device power Мощность источника света или устройства Потужність джерела світла або пристрою		Czas pracy Nominal lifetime Время работы Час роботи
	Strumień świetlny Luminous flux Луч свечения Світловий потік		Długość przewodu Wire length Длина провода Довжина кабелю
	Długość produktu Product length Длина изделия Довжина виробу		Długość przewodu z wtyczką Length of cord with plug Длина провода с вилкой Довжина кабелю з вилокю
	Materiał obudowy produktu Product casing material Материал корпуса продукта Матеріал корпусу продукту		Długość taśmy LED LED strip length Длина ленты LED Довжина стрічки LED
	Kolor obudowy Casing color Цвет корпуса Колір корпусу		Stopień ochrony IK IK degree of protection Пылевлагозащита IK Ступінь захисту IK
	Temperatura barwowa światła Color temperature Цветовая температура Колірна температура світла		Waga Weight Вес Вага
	Maksymalna ilość opraw do połączenia w linie Maximum unit in line connection Максимальное количество светильников для подключения в линию Максимальна кількість світильників, для підключення в лінії		Rodzaj złączki Type of connector Тип соединителя Тип кріплення
	Klasa energetyczna Energy efficiency class Класс энергоэффективности Клас енергоефективності		Współczynnik oddawania barw Colour rendering index Индекс цветопередачи Індекс передачі кольору
	Zasilanie Voltage Напряжение Напряга		Współczynnik mocy Power factor Фактор силы Коефіцієнт потужності
	Zasilanie napięciem 12 V prąd stały 12 V power supply DC Напряжение питания 12 В постоянный ток Живлення напругою 12 В постійного струму		Współczynnik ośnienia Unified glare rating Кoefficient ослепленности Коефіцієнт осліплення
	Napięcie wyjściowe Output voltage Выходное напряжение Вихідна напруга		Czas włączania Starting time (max) Время включения Час вмикання
	Maksymalne dopuszczalne obciążenie Max permissible load Максимально допустимая нагрузка Максимально допустиме навантаження		



Liczba cykli w/wył
Switching cycle
Количество циклов вкл./выкл.
Кількість циклів вкл/выкл



Współpracuje ze ściemniaczami
Dimmable
Есть возможность подключения диммера
Працює з диммерами



Nie współpracuje ze ściemniaczami
Non-dimmable
Нет возможности подключения диммера
Не працює з диммерами



Rodzaj diody LED
Types of LED diode
Тип диодов LED
Тип світлодіодів



Ilość diod LED
Number of LED diodes
Количество диодов LED
Кількість світлодіодів



Dopuszczalna temperatura pracy
Allowable working temperature
Допустимая рабочая температура
Допустима робоча температура



Rodzaj świetlówki
Type of fluorescent tube
Тип люминесцентной лампы EVG
Тип люмінесцентної лампи



Przekrój przewodu
Wire cross section
Сечение провода
Перетин дроту



Maksymalny zasięg czujnika ruchu
Motion sensor range
Дальность датчика движения
Максимальний радіус дії датчика руху



Kąt widzenia czujnika ruchu
Motion sensor detection angle
Угол обзора датчика движения
Кут огляду датчика руху



Zawartość rtęci
Mercury content
Содержание ртути
Вміст ртуті



Gniazdo Schuko
Schuko socket
Гнездо Schuko
Розетка Schuko



Gniazdo French
French socket
Гнездо French
Розетка French



USB
USB port
USB-порт
USB-порт



Ładowanie przez USB
USB charge
USB зарядка
USB зарядка



Maksymalne obciążenie gniazd USB
Max load USB ports
Максимальное количество портов USB
Максимальне навантаження портів USB



Gniazdo UK
UK socket
Гнездо UK
Розетка UK



Oprawa z włącznikiem
Fixture with switch
Светильник с выключателем
Світильник з вимикачем



Wyłącznik termiczny
Thermal switch
Термовыключатель
Тепловий вимикач



Rekomendowana odległość montażu od powierzchni
Recommended mounting distance from surfaces
Рекомендуется монтаж устройства на расстоянии
Рекомендована відстань установки від поверхні



Średnica otworu montażowego
Mounting hole diameter
Монтажное отверстие диаметром
Діаметр монтажного отвору



Statecznik EVG
Electrical ballast EVG
Пусковое устройство EVG
Баласт EVG



Brak efektu migotania
Flicker free
Нет мерцающего эффекта
Відсутність ефекту мерехтіння



Możliwość montażu modułu awaryjnego CNBOP
Ready for emergency unit assembly
Возможность монтажа аварийного модуля CNBOP
Можливість установки блоку аварійного CNBOP



Pojemność baterii
Battery capacity
Емкость аккумулятора
Ємність батареї



Typ Baterii
Battery type
Тип батареи
Тип батареї



Długość przewodu z wtyczką mini AMP
Length of the cable with mini connector
Длина кабеля с мини-штекером AMP
Довжина кабелю з mini AMP



Długość przewodu z zasilaczem
Length of the cable with driver
Длина кабеля с блоком питания
Довжина кабелю з блоком живлення



Gniazdo RJ45
RJ45 socket
Гнездо RJ45
Роз'єм RJ45



Gniazdo ethernet
Ethernet socket
Гнездо ethernet
Роз'єм ethernet



Gniazdo HDMI
HDMI socket
Гнездо HDMI
Роз'єм HDMI



Ilość gniazd
Number of sockets
Количество розеток
Кількість слотів



Klasa ochronności I
Protection class I
I класс защиты
Клас захисту I



Klasa ochronności II
Protection class II
II класс защиты
Клас захисту II



Klasa ochronności III
Protection class III
III класс защиты
Клас захисту III



Kostka przyłączeniowa - maksymalny przekrój przewodu
Terminal block - maximum cable cross section
Винтовой зажим - максимальное сечение кабеля
Гвинтовий затиск - максимальний перетин кабелю



Maksymalny horyzont kąta działania czujnika
Maximum sensor angle operation
Максимальный горизонт угла наклона датчика
Максимальний горизонт кута дії датчика



Maksymalny prąd obciążenia
Maximum current load
Максимальный ток нагрузки
Максимальний струм навантаження

- 

Miejsce montażu
Place of assembly
Место монтажа
Місце монтажу
- 

Montaż natynkowy
Surface mounting
Поверхностный монтаж
Поверхневий монтаж
- 

Montaż wpuszczany
Flush mount
Скрытый монтаж
Врізний монтаж
- 

Czujnik jednobiegowy
Single-pole sensor
Однополюсный датчик
Однополюсний датчик
- 

Czujnik dwubiegowy
Double-pole sensor
Двухполюсный датчик
Двополюсний датчик
- 

Zabezpieczenie przepięciowe
Overvoltage protection
Защита от перенапряжения
Захист від перенапруги
- 

Przycisk TEST
TEST button
Кнопка TEST
Кнопка TEST
- 

Fukcja ZOOM
ZOOM function
Функция ZOOM
Функція ZOOM
- 

Funkcja czerwonego światła ostrzegawczego
Red light warning function
Функция красной сигнальной лампы
Функція червоного попереджувального світла
- 

Uchwyt magnetyczny
Magnetic handle
Магнитный держатель
Магнітний тримач
- 

Trzy tryby świecenia
Three lighting modes
Три режима освещения
Три режими освітлення
- 

Funkcja flash
Flash function
Функция вспышки
Функція спалаху
- 

Funkcja Power Bank
Power Bank function
Функция Power Bank
Функція Power Bank
- 

Oprowa świecąca z dwóch stron
Two-sided luminaire
Двусторонний светильник
Двосторонній світильник

- 

Mikrofalowy czujnik ruchu
Microwave motion sensor
Датчик движения СВЧ
Мікрохвильова датчик руху
- 

Czujnik ruchu IR
Motion Sensor IR
Датчик движения ИК
Датчик руху ІЧ
- 

Czujnik ruchu PIR
Motion Sensor PIR
Датчик движения PIR
Датчик руху PIR
- 

3 sposoby świecenia: (zewn, wewn, zewn+wewn)
3 types of lighting: (outside, inside, outside + inside)
3 способа свечения: (внешн, внутр, внешн+внутр)
3 способи світіння: (зовніш, внутр, зовніш.+внутр)
- 

3-stopniowy czujnik ruchu
3 step motion sensor
3-ступенчатый датчик движения
3-ступінчастий датчик руху
- 

3 tryby załączania źródła światła
CCT 3 colour modes switch
3 режима регулировки цвета света
источника света
3 режими колірної температури
джерела світла
- 

3-stopniowa regulacja jasności
3 step brightness adjustment
3-ступенчатая регулировка яркости
3-ступінчасте регулювання яскравості
- 

2 tryby załączania źródła światła
CCT 2 colour modes switch
2 режима регулировки цвета света
источника света
2 режими колірної температури джерела світла
- 

Opcja ściemniania
Dimmable
Диммируемый
Регулювання яскравості

Ikony elektrotechniczne pozostałe - rodzaj trzonka
Electrical engineering icons – base type
Электротехнические иконки – тип цоколя
Електротехнічні значки інші-тип цоколя

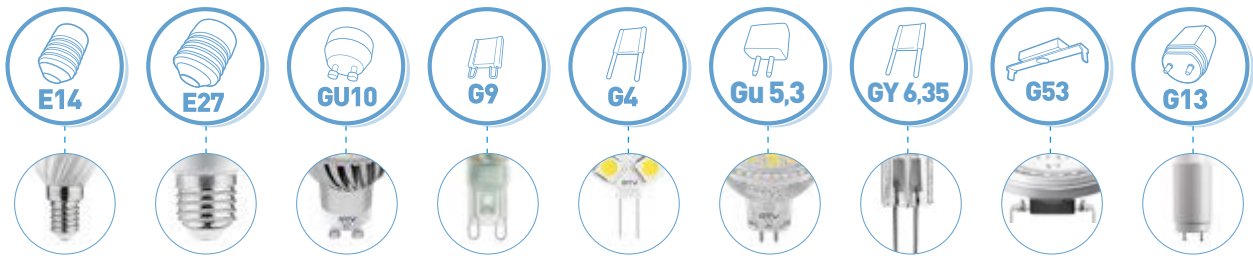

Na zamówienie wersja DALI
DALI on order
DALI на заказ
На замовлення версія DALI



Na zamówienie oprawa przystosowana do częstego załączania
np. współpraca z czujkami ruchu.
Luminaire is compatible with motion detector on request
По заказу светильник предназначенный для работы с датчиками движения
На замовлення світильник, призначений для частого перемикання наприклад,
робота з датчиками руху.



Maksymalna ilość opraw do połączenia w linie
Maximum unit in line connection
Максимальное количество светильников для
подключения в линию
Максимальна кількість світильників, для
підключення в лінії



Piktogramem oznaczone są łączniki, w których można
podłączyć zasilanie szynoprzewodu.
Connectors that can be plugged into the grid are marked by this
pictogram
Пиктограммой обозначены соединители, в которых
можно подключить питание шинпровода.
Піктограмою позначені роз'єми, в яких можна
підключити живлення шинпровода.



Możliwość podłączenia bez użycia narzędzi
No-tool connection option
Возможность подключения без инструментов
Можливість підключення без використання
інструментів



Maksymalna rozpraszana moc źródła światła dla profilu rozgrzanego
do maksymalnie 65 stopni C, dla wersji z kloszem.*
Maximal dissipated power of lamps for heated profiles to 65°C,
when applied with lampshades.*
Максимальная рассеиваемая мощность источников света для
нагреваемого профиля до максимум 65 °С, для версии с абажуром.*
Максимальна розсіюється потужність джерел світла для профілю
розпеченого максимум до 65 градусів С, для версії з плафоном.*



Brak efektu oślnienia
No glare effect
Отсутствие эффекта слепимости
Відсутність ефекту слемимости



Ładowanie bezprzewodowe
Wireless charging
Беспроводная зарядка
Бездротова зарядка



Fukcja SOS, ZOOM
SOS, ZOOM function
Функция SOS, ZOOM
Функція SOS, ZOOM



Współpracuje z modulem awaryjnym
Emergency module compatibility
Работает с модулем аварийного питания
Працює з аварійним модулем

* Rzeczywiste wartości mocy, strumienia świetlnego, temperatury barwowej mogą się różnić w granicach ±5% od podanych wartości. Maksymalna temperatura otoczenia dla powyższych wyników wynosi 24 stopnie C. Kompatybilność taśmy LED z profilem LED zależy od sposobu oraz miejsca montażu.
Real power value, luminous flux, colour temperature may vary within 5% of stated values. Maximal temperature of surroundings for above results is 24°C. Compatibility of LED tape and LED profile depends on a method and place of assembling.

Фактичні значення потужності, світлового потоку, кольорної температури можуть варіюватися в межах ±5% від заданих значень. Максимальна температура навколишньої середовища для вищеуказаних показателів становить 24°C. Совместимость светодиодной ленты со светодиодным профилем зависит от способа и места установки.

Фактичні значення потужності світлового потоку, колірної температури можуть варіюватися в межах ±5% від заданих значень. Максимальна температура навколишнього середовища для цих результатів становить 24 градуси С. Сумісність СВІТЛОДІОДНА стрічка з профілем LED, залежать від способу і місця монтажу.

PL Cyfrowy miernik uniwersalny EN Universal digital meter RU Универсальный цифровой измеритель UK Універсальний цифровий вимірювач



AUTO-RANGE	U.D.C. 600V U.A.C. 600V	I.D.C. 10A
R 2MΩ	DATA HOLD	
LED DIODE	1999 DISPLAY	BATTERY 1,5 / 9V

HT1E602	160 x 75 x 30 mm	1	50

PL Cyfrowy miernik uniwersalny EN Universal digital meter RU Универсальный цифровой измеритель UK Універсальний цифровий вимірювач



NCV	TRUE RMS	SMART U AC/DC	AUTO-RANGE
U.D.C. 600V U.A.C. 600V	I.D.C. 10A I.A.C. 10A	R 99,99MΩ	C 10 mF
BATTERY 1,5 / 9V	DATA HOLD	LED DIODE	9999 DISPLAY

HT1E601	150 x 70 x 50 mm	1	40

PL Cyfrowy miernik uniwersalny EN Universal digital meter RU Универсальный цифровой измеритель UK Універсальний цифровий вимірювач



TRUE RMS	AUTO-RANGE	SELECT	RANGE
RELATIVE	U.D.C. 600V U.A.C. 600V	I.D.C. 10A I.A.C. 10A	R 60MΩ
C 60mF	-20°C ~1000°C	0-10 MHz	DATA HOLD
MIN/MAX		5999 DISPLAY	

HT1E604	190 x 90 x 40 mm	1	20

PL Cęgowy miernik uniwersalny EN Universal clamp meter RU Токовый тестер цифровой UK Щипцевий універсальний вимірювач магетіс пристрій



NCV	TRUE RMS	AUTO-RANGE	U.D.C. 600V U.A.C. 600V	I.A.C. 600A
R 60MΩ	MAX Ø20 mm	DATA HOLD	MIN/MAX	SELECT
	RANGE		5999 DISPLAY	

HT1E621	1	20

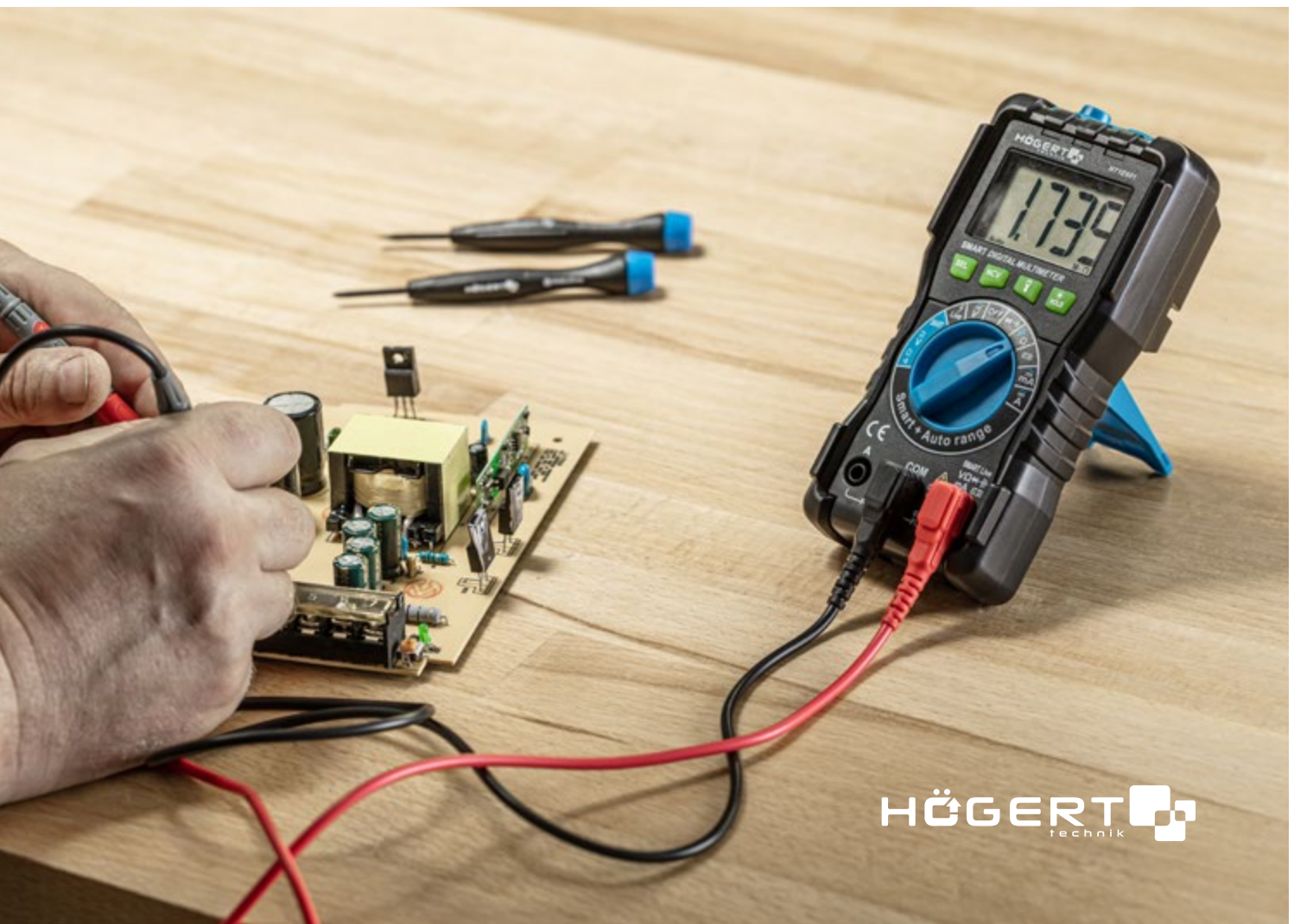



PL Szczypce do cięcia przewodów EN Cable cutting pliers RU Кусачки для резки проводов UK Щипці для різки проводів

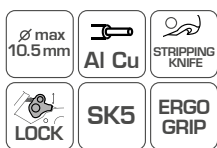

HT1P046	168 mm	∅ 10,5 mm	10	60

PL Szczypce do cięcia przewodów EN Cable cutting pliers RU Бокорезы UK Щипці для різки проводів



HT1P042	160 mm	∅ 3 mm	6	60
HT1P044	200 mm	∅ 11 mm	6	60

PL Nożyce do kabli EN Cable Cutter RU Кабелерез UK Ножиці для кабелів

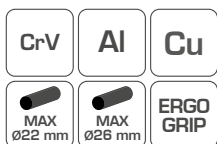

HT1P048	450 mm	1	12
HT1P049	600 mm	1	12

PL Szczypce do cięcia przewodów EN Cable cutter pliers RU Кусачки для резки проводов UK Щипці для різки проводів



HT1P045	185 mm	1,3 - 8,0 mm ² (16, 14, 12, 10, 8 AWG)	10	120

PL Automacyjny ściągacz izolacji EN Automatic wire stripper RU Клещи автома-
-тические для снятия изоляции UK Автоматичний знімач ізоляції

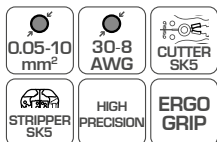

HT1P182	210 mm	0,05 to 10,0 mm ² (30-8 AWG)	10	60
---------	--------	--	----	----

PL Ściągacz izolacji EN Wire stripper RU Инструмент для зачистки проводов
UK Знімач ізоляції

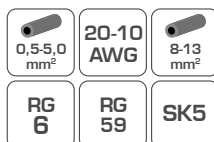

HT1P102	122 mm	0,5-6,0 mm ² (20-10 AWG)	15	90
---------	--------	--	----	----

PL Automacyjny ściągacz izolacji EN Automatic wire stripper RU Клещи для снятия
изоляции UK Автоматичний знімач ізоляції



HT1P188	168 mm	1,0-3,2 mm ² (18-12 AWG)	8	48
---------	--------	--	---	----

PL Ściągacz izolacji EN Wire stripper RU Инструмент для зачистки проводов
UK Знімач ізоляції

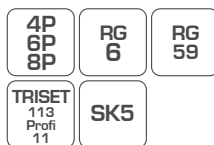







HT1P103	125 mm	RG-6, RG-59, Triset-113, Triset Profi, Triset-11	10	50
---------	--------	---	----	----





PL Szczypce do zaciskania z wymiennymi szczękami EN Crimping plier interchangeable RU Клещи для обжима со сменными матрицами UK Щипці для затискання зі змінними губами



- A  0.5 - 6 mm² (22 - 10 AWG)
- A1  0.5 - 10 mm² (22 - 8 AWG)
- A2  0.5 - 6 mm² (22 - 10 AWG)
- A3  0.1 - 1.5 mm² (26 - 16 AWG)
- A4  0.5 - 2.5 mm² (22 - 14 AWG)
- A5  0.5 - 6 mm² (22 - 10 AWG)

×7
QUICK EXCHANGE
RATCHET
ERGO GRIP





			
HT1P176	220 mm	1	10

PL Szczypce do zaciskania tulejek cienkościennych EN Ferrule crimper wire plier RU Пресс-клещи для зажатия кабельных муфт UK Щипці для затискання тонкостінних муфт







				
HT1P205	175 mm	0.25 - 6 mm ² (23 - 10 AWG)	10	50



PL Zestaw wkrętek 1000 V **EN** Insulated 1000 V screwdriver set **RU** Набор изолированных отверток 1000 V **UK** Набор викруток 1000 V



\varnothing 1,2 x 6,5 x 100 mm,
 1,0 x 5,5 x 100 mm,
 0,8 x 4,0 x 100 mm,
 0,5 x 3,0 x 100 mm
 Φ PH2 x 100 mm,
 PH1 x 80 mm,
 PZ2 x 100 mm,
 PZ1 x 80 mm
 \bullet T10 x 100 mm,
 T15 x 100 mm,
 T20 x 100 mm
 Voltage tester 140 mm



x13 VDE 1000V S2 MAGNETIC ERGO GRIP

HT1S977	1	72

PL Szczypce uniwersalne 1000 V **EN** Insulated combination pliers 1000 V **RU** Плоско-губцы универсальные 1000 V **UK** Універсальні щипці 1000 В



VDE 1000V CrV HRC 55-60 DIN 5749

HT1P903	160 mm	6	60
HT1P905	180 mm	6	60
HT1P907	200 mm	6	60

PL Wkrętko 1000 V płasko-krzyżowy SLIM **EN** Insulated 1000 V SLIM screwdriver **RU** Отвертка изолированная плоско-крестовая SLIM 1000 V **UK** Викрутка з плоским і хрестоподібним шліцом 1000 V SLIM

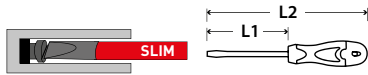

VDE 1000V SLIM PH
 PZ SL CrMo
 MAGNETIC ERGO GRIP EN 60900

		L1	L2		
HT1S973	PH1/SL5	100 mm	192 mm	12	240
HT1S974	PH2/SL6	100 mm	210 mm	12	120
HT1S976	PZ1/SL5	100 mm	192 mm	12	240
HT1S977	PZ2/SL6	100 mm	210 mm	12	120

PL Szczypce boczne 1000 V **EN** Insulated diagonal side cutters 1000 V **RU** Бокорезы 1000 V **UK** Бічні щипці 1000 В



VDE 1000V CrV HRC 55-60 DIN 5749 HIGH LEVERAGE

HT1P909	160 mm	6	60
HT1P911	180 mm	6	60

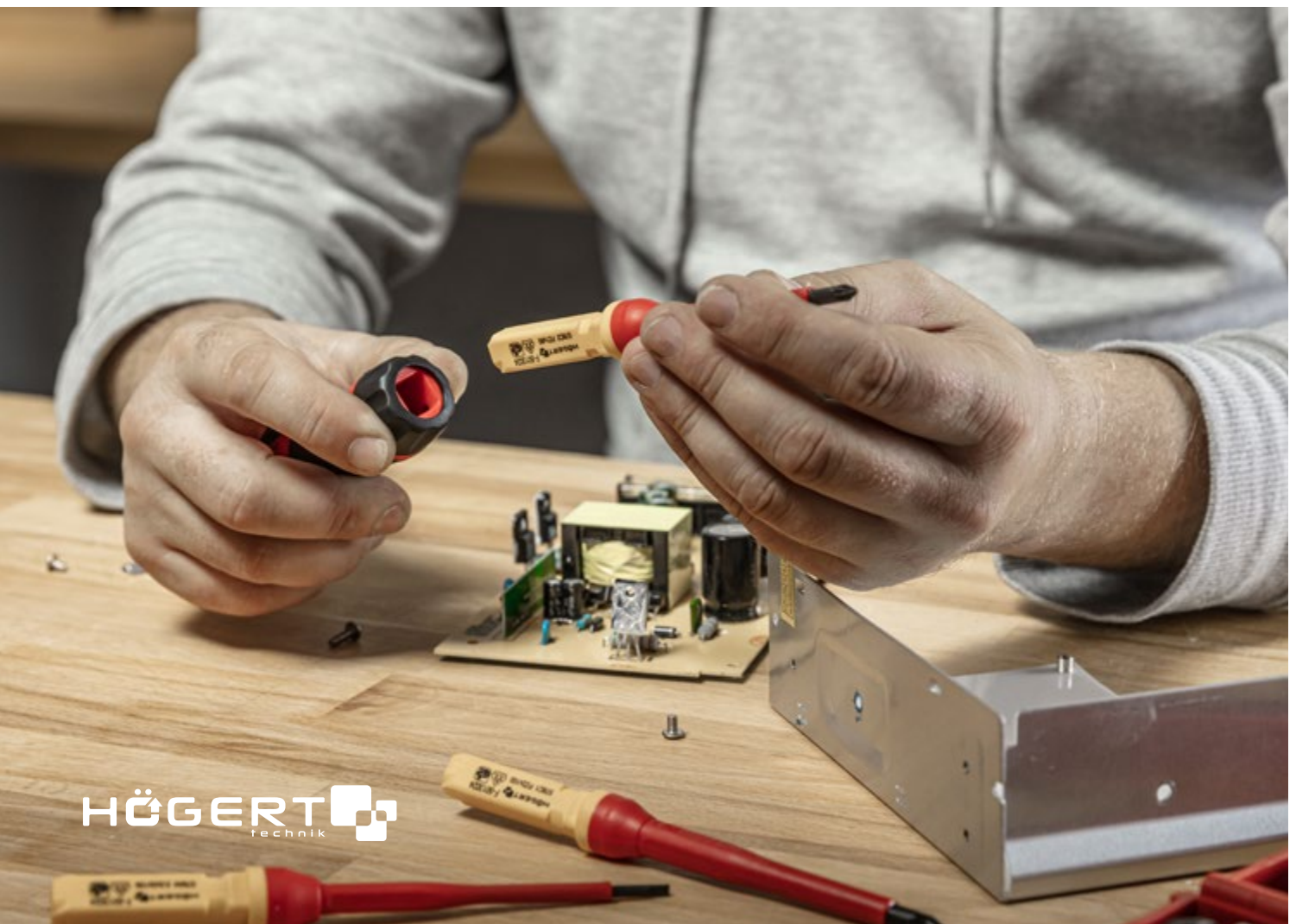



A

AE-27GU10-00.....	388
AE-BPW1FACP-10.....	478
AE-BPW1FACP-20.....	478
AE-BPW1S1UCH-51.....	489
AE-BPW1S1UCH-53.....	488
AE-BPW1S2UCH-80.....	488
AE-BPW1SACP-10.....	478
AE-BPW1SACP-20.....	478
AE-BPW1U1UCH-51.....	489
AE-BPW1U1UCH-53.....	488
AE-BPW1U2UCH-80.....	488
AE-BPW2FCAM-10.....	482
AE-BPW2FCAM-20.....	482
AE-BPW2SCAM-10.....	482
AE-BPW2SCAM-20.....	482
AE-BPW3GS-20.....	490
AE-BPW3GS-80.....	490
AE-BPW3GU-20.....	490
AE-BPW3GU-80.....	490
AE-BPW3S60-20.....	490
AE-BPW3S60-80.....	490
AE-BPW3S60U-20.....	490
AE-BPW3S60U-80.....	490
AE-BPW3S100U-53.....	489
AE-BPW3U60-20.....	490
AE-BPW3U60-80.....	490
AE-BPW3U60U-20.....	490
AE-BPW3U60U-80.....	490
AE-BPW3U100U-53.....	489
AE-BPW4F120P-10.....	480
AE-BPW4F120P-20.....	480
AE-BPW4S100-53.....	489
AE-BPW4S120P-10.....	480
AE-BPW4S120P-20.....	480
AE-BPW4U100-53.....	489
AE-CANOPY-10.....	393
AE-CM3M00-00.....	372
AE-CM3M00-10.....	372
AE-CM1000-00.....	371
AE-CM1500-00.....	375
AE-CM3000-00.....	372
AE-CM4000-00.....	373
AE-CM5000-00.....	373
AE-CM6000-00.....	374
AE-CM9000-00.....	375
AE-CM9000-10.....	375
AE-E14E27-00.....	388
AE-E14GU10-00.....	387
AE-E14RING-10.....	389
AE-E27E14-00.....	388
AE-E27RING-10.....	389
AE-E40E27-00.....	389
AE-GIR10-10.....	287
AE-GR610-10.....	286
AE-GU10E27-00.....	389
AE-MA8028-00.....	392
AE-MA8028-10.....	392
AE-MAS80X80-00.....	392
AE-MAS80X80-10.....	392
AE-OCEE14-00.....	385
AE-OCEE27-00.....	386
AE-OCEE27-MM.....	386
AE-OCEE40-00.....	386
AE-OCEF27-00.....	385
AE-OPE27P-00.....	387
AE-PB1FAVA-10.....	486
AE-PB1FAVA-20.....	486
AE-PB1FAVA-53.....	486
AE-PB1FAVAP-10.....	484
AE-PB1FAVAP-20.....	484
AE-PB1FAVAP-53.....	484
AE-PB1SAVA-10.....	486
AE-PB1SAVA-20.....	486

AE-PB1SAVA-53.....	486
AE-PB1SAVAP-10.....	484
AE-PB1SAVAP-20.....	484
AE-PB1SAVAP-53.....	484
AE-PB2FPRES-10.....	476
AE-PB2FPRES-20.....	476
AE-PB2FPRES-53.....	476
AE-PB2SPRES-10.....	476
AE-PB2SPRES-20.....	476
AE-PB2SPRES-53.....	476
AE-PB03GS-10.....	491
AE-PB03GS-20.....	491
AE-PB03GS-53.....	491
AE-PB03GU-53.....	491
AE-PBC3GS2U-53BKS.....	494
AE-PBC3GS-51BK.....	494
AE-PBC3GS-53BKS.....	494
AE-PBC3GU-10.....	491
AE-PBC3GU-20.....	491
AE-PBC3GU-51BK.....	494
AE-PBC3GU-53.....	491
AE-PBKT3S2U-80.....	495
AE-PBKT3U2U-80.....	495
AE-PBKT4S-80.....	495
AE-PBKT4U-80.....	495
AE-PBSC3GS-10.....	492
AE-PBSC3GS-20N.....	492
AE-PBSC3GS-53.....	492
AE-PBSC3GU-10.....	492
AE-PBSC3GU-20N.....	492
AE-PBSC3GU-53.....	492
AE-PBSUC2GS-10.....	492
AE-PBSUC2GS-20N.....	492
AE-PBSUC2GS-53.....	492
AE-PBSUC2GU-10.....	492
AE-PBSUC2GU-20N.....	492
AE-PBSUC2GU-53.....	492
AE-PBU02GS-10.....	491
AE-PBU02GS-20.....	491
AE-PBU2GU-10.....	491
AE-PBU2GU-20.....	491
AE-PBU2GU-53.....	491
AE-PF3G1M-00.....	380
AE-PF3G3M-00.....	380
AE-PF3G5M-00.....	380
AE-PF5G3M-00.....	380
AE-PF5G5M-00.....	380
AE-PFBEBEN-20.....	381
AE-PFBEBEN-40.....	381
AE-POGRODUN-10.....	382
AE-POGRODUN-20.....	382
AE-POGRODUN-30.....	382
AE-PS3G3M-00.....	380
AE-PS3G5M-00.....	380
AE-PS4G3M-00.....	380
AE-PS4G5M-00.....	380
AE-PS5G3M-00.....	380
AE-PS5G5M-00.....	380
AE-RU0102-00.....	383
AE-RU0103-00.....	385
AE-RU0121-00.....	383
AE-SBEBEN-30.....	381
AE-SBEBEN-50.....	381
AE-SC0102-00.....	384
AE-SC0103-00.....	384
AE-SRC812-00.....	377
AE-SRC812-MIN.....	376
AE-SRC812-MIN2.....	376
AE-VA1UNI-00.....	384
AE-VA1UNI-10.....	384
AE-WBBUNI-10DIM.....	462
AE-WBCUNI-10DIM.....	462
AE-WBE1-10.....	462
AE-WBE1-20.....	462
AE-WBE2-10.....	463

AE-WBE2-20.....	463
AE-WBEZDB-10S*.....	460
AE-WBEZDC-10S.....	460
AE-WBEZDK15-10.....	460
AE-WBEZD-NBN.....	464
AE-WBEZDPIR2-20.....	461
AE-WBEZDPIR-10.....	461
AE-WDBP1-10N.....	458
AE-WDBP1-20N.....	458
AE-WDBP2CCT-10N.....	458
AE-WDBP2CCT-20N.....	458
AE-WDSB-10DIM.....	463
AE-WDSC-10DIM.....	463
AE-WLB01-10.....	465
AE-WLC01-20.....	465
AE-WLIP44-15.....	466
AE-WLLAN1-10.....	467
AE-WLLAN1-20.....	467
AE-WLLAN1-90.....	467
AE-WLPR-60.....	465
AE-WLPR-60P2.....	465
AE-WLSZN1-10.....	467
AE-WPDRW-00.....	464
AE-ZLADLUX-40.....	473
AE-ZLADPOD-20.....	473
AE-ZUSB-20.....	474

B

BK-BHLO50-1000BZ.....	396
BK-BHLO60-1300BZ.....	396
BK-PULO30A-0700AD.....	396
BK-PULO42A-0700BD.....	396
BK-PULO42A-1100AD.....	396
BK-PULO60A-2000AD.....	396

C

CR-CO1000-00.....	366
CR-CO2000-00.....	366
CR-CR3M00-00.....	361
CR-CR3M00-10.....	361
CR-CR4L00-00.....	362
CR-CR5M00-00.....	363
CR-CR9M00-00.....	365
CR-CR9M00-10.....	365
CR-CR1000-00.....	360
CR-CR1000-10.....	360
CR-CR1100-00.....	367
CR-CR1200-00.....	367
CR-CR1400-00.....	368
CR-CR2000-00.....	360
CR-CR2000-10.....	360
CR-CR3000-00.....	361
CR-CR3000-10.....	361
CR-CR5000-00.....	362
CR-CR6000-00.....	363
CR-CR7000-00.....	364
CR-CR8000-00.....	364
CR-CR9000-00.....	365
CR-CR9000-10.....	365
CR-CR13000-00.....	368
CR-CR15000-00.....	369
CR-CR16000-00.....	369
CR-CR17000-00.....	370
CR-CR18000-00.....	370
CR-CR19000-00.....	371
CZ-CZ1000-00.....	377
CZ-CZ2000-00.....	378

G

GT-RM30X60-00.....	75
GT-RM30X120-00.....	75
GT-RM60X60-00.....	75
GZ-E27000-00.....	387

GZ-E27000-10.....	387
GZ-G90000-00.....	383
GZ-GZ10-0000.....	382
GZ-MR16-0000*.....	382

K

KB-W310HUG-20.....	394
KB-W313HUG-20.....	394

L

LB-ARCH8W-00.....	307
LB-ARCH8W-10.....	307
LB-BRE8W-11-DEC.....	304
LB-BRE8W-15-DEC.....	304
LB-FLOW4W-06-DEC.....	298
LB-FRO5W-00-DEC.....	296
LB-GAL3WRU-10.....	295
LB-GAL5WMO-10.....	300
LB-GAL5WRU-10.....	295
LB-GAL8W-00-DEC.....	302
LB-GAL8W-10-DEC.....	302
LB-HAL8W-00-DEC.....	296
LB-HAL8W-10-DEC.....	296
LB-HEL6W-00-DEC.....	304
LB-HEL6W-15-DEC.....	304
LB-HEL6W-20-DEC.....	304
LB-HEL6W-25-DEC.....	304
LB-HIK6WCCT-00.....	298
LB-HIK6WCCT-10.....	298
LB-IZK6WCCT-00.....	299
LB-IZK6WCCT-10.....	299
LB-LIN7W-00-DEC.....	300
LB-LIN7W-10-DEC.....	300
LB-LON12W-10-DEC.....	306
LB-MON3W-02-DEC.....	306
LB-MON3W-40-DEC.....	306
LB-MON3W-41-DEC.....	306
LB-TRIT6W-00-DEC.....	303
LB-TRIT6W-10-DEC.....	303
LB-VEN20W-10.....	307
LB-VEN20WO-00.....	307
LD-3SKL-ZBN.....	445
LD-120G14W-32.....	42
LD-120G14W-40.....	42
LD-120G18W-32.....	42
LD-120G18W-40.....	42
LD-2835-24V-300-20-CB.....	407
LD-2835-24V-300-20-NE4.....	407
LD-2835-24V-300-20-ZB.....	407
LD-2835-24V-600-20-CB.....	407
LD-2835-24V-600-20-NE4.....	407
LD-2835-24V-600-20-ZB.....	407
LD-2835-60-60-20-CCT.....	405
LD-2835-300-20-CB.....	404
LD-2835-300-20-CB-50.....	406
LD-2835-300-20-CBN.....	404
LD-2835-300-20-NE4N.....	404
LD-2835-300-20-NE4P.....	404
LD-2835-300-20-NE4P-50.....	406
LD-2835-300-20-ZB.....	404
LD-2835-300-20-ZB-50.....	406
LD-2835-300-20-ZBN.....	404
LD-2835-300-65-CB.....	404
LD-2835-300-65-CBN.....	404
LD-2835-300-65-NE4.....	404
LD-2835-300-65-NE4N.....	404
LD-2835-300-65-ZB.....	404
LD-2835-300-65-ZBN.....	404
LD-2835-600-5MM-20-CB.....	405
LD-2835-600-5MM-20-NE4.....	405
LD-2835-600-5MM-20-ZB.....	405
LD-2835-600-20-CB.....	404
LD-2835-600-20-NE4.....	404
LD-2835-600-20-ZB.....	404

LD-2835-600-65-CB.....	404	LD-ASTID13-NW-00.....	95	LD-CS36ZB-53.....	440	LD-G4025W-30.....	58
LD-2835-600-65-NE4.....	404	LD-ASTR12WM-NW-00.....	96	LD-DA200W-40.....	127	LD-GL40060-NB.....	69
LD-2835-600-65-ZB.....	404	LD-ASTR12W-NW-00.....	95	LD-DAL100W-NB.....	136	LD-GL40060UGR-NB.....	70
LD-3014-1200-20-CB.....	405	LD-ASTR18WM-NW-00.....	96	LD-DAL150W-NB.....	136	LD-GL40120-NB.....	69
LD-3014-1200-20-NE4.....	405	LD-ASTR18W-NW-00.....	95	LD-DC24A60-12.....	39	LD-HAG136-30.....	152
LD-3014-1200-20-ZB.....	405	LD-ASTR24WM-NW-00.....	96	LD-DE40062-NB.....	73	LD-HAG158-30.....	152
LD-3528-300-20-CB.....	404	LD-ASTR24W-NW-00.....	95	LD-DE40062UGR-NB.....	73	LD-HAG218-30.....	152
LD-3528-300-20-CB-50.....	406	LD-ATM15WBP-NB.....	184	LD-DELOR6WC-NB.....	102	LD-HAG236-30.....	152
LD-3528-300-20-NE4P.....	404	LD-ATM15WCP-NB.....	184	LD-DELOW6WC-NB.....	102	LD-HAG236KL-ME.....	153
LD-3528-300-20-NE4P-50.....	406	LD-ATM20WBK-NB.....	184	LD-DIMLED-10.....	466	LD-HAG236KL-ME.....	153
LD-3528-300-20-NI.....	404	LD-ATM20WCK-NB.....	184	LD-DNV15W-NB.....	122	LD-HAG258-30.....	152
LD-3528-300-20-ZB.....	404	LD-ATOL32W-NW-02.....	91	LD-DNV20W-NB.....	122	LD-HB150W-40.....	134
LD-3528-300-20-ZB-50.....	406	LD-ATOL32W-NW-10.....	91	LD-DNV30W-NB.....	122	LD-HEL136B-30.....	152
LD-3528-300-65-CB.....	404	LD-ATOL32W-WW-40.....	91	LD-E14P35WE-30.....	30	LD-HEL218B-30.....	152
LD-3528-300-65-NE4.....	404	LD-ATOL32W-WW-02.....	91	LD-E14S2WE0-40.....	30	LD-HEL236B-30.....	152
LD-3528-300-65-ZB.....	404	LD-ATOL32W-WW-10.....	91	LD-ES111NW11W25AG-01.....	57	LD-HEL236BU-ME.....	153
LD-3528-600-20-CB.....	404	LD-ATOL32W-WW-40.....	91	LD-ES111NW13W40-00.....	56	LD-HEL236BU-ME.....	153
LD-3528-600-20-CB-50.....	406	LD-BA2E27-00.....	285	LD-ES111NW13W40-10.....	56	LD-HEL258B-30.....	152
LD-3528-600-20-NE4.....	404	LD-BA2GU10-0M.....	285	LD-ES111NW13W40-15.....	56	LD-HEL258BU-ME.....	153
LD-3528-600-20-NE4-50.....	406	LD-BALE27-00.....	285	LD-ES111NW13W120-00.....	56	LD-HEL258BU-ME.....	153
LD-3528-600-20-ZB.....	404	LD-BALGU10-0S.....	285	LD-ES111NW13W120-10.....	56	LD-HER60W12-NB.....	82
LD-3528-600-20-ZB-50.....	406	LD-BERGA50W-30.....	77	LD-ES111NW13W120-15.....	56	LD-HR2X18W12-30.....	80
LD-3528-600-65-CB.....	404	LD-BERGA70W-30.....	77	LD-ES111WW11W25AG-01.....	57	LD-ILUXC10W-64.....	130
LD-3528-600-65-NE4.....	404	LD-BES24WKW-30.....	87	LD-ES111WW13W40-00.....	56	LD-ILUXC20W-64.....	130
LD-3528-600-65-ZB.....	404	LD-BES24WKW-40.....	87	LD-ES111WW13W40-10.....	56	LD-ILUXC30W-64.....	130
LD-5050-300-20-CB.....	405	LD-BES24WOK-30.....	87	LD-ES111WW13W40-15.....	56	LD-ILUXC50W-64.....	130
LD-5050-300-20-NE4.....	405	LD-BES24WOK-40.....	87	LD-ES111WW13W120-00.....	56	LD-ILUXC100W-64.....	130
LD-5050-300-20-NE4-50.....	406	LD-BESTA40W-30.....	78	LD-ES111WW13W120-10.....	56	LD-ILUXCC10W-64.....	130
LD-5050-300-20-ZB.....	405	LD-BESTA60W-30.....	78	LD-ES111WW13W120-15.....	56	LD-ILUXCC20W-64.....	130
LD-5050-300-65-CB.....	405	LD-BETISD50W-30.....	77	LD-ESKA084-51.....	246	LD-ILUXCC30W-64.....	130
LD-5050-300-65-NE4.....	405	LD-BETISD70W-30.....	77	LD-ESKB084-51.....	246	LD-ILUXCC50W-64.....	130
LD-5050-300-65-ZB.....	405	LD-BLRKW18W-61.....	116	LD-ESOA084-51.....	244	LD-ILUXC100W-64.....	130
LD-5630-300-20-CB.....	405	LD-BLR0K18W-61.....	116	LD-ESOB084-51.....	244	LD-IND60W-40.....	140
LD-5630-300-20-NE4.....	405	LD-BNC8WKB-NB.....	176	LD-FEN20W-NW-00.....	90	LD-IND100W-40.....	140
LD-5630-300-20-NE4-50.....	406	LD-BNC8WKC-NB.....	176	LD-FEN30W-NW-00.....	90	LD-IND150W-40.....	140
LD-5630-300-20-ZB.....	405	LD-BNC8WOB-NB.....	176	LD-FRT36WB-NB.....	174	LD-INEXT10W-64.....	128
LD-5630-300-65-CB.....	405	LD-BNC8WOC-NB.....	176	LD-G4P30W-30.....	58	LD-INEXT20W-64.....	128
LD-5630-300-65-NE4.....	405	LD-BNC15WKB-NB.....	180	LD-G4P30W-40.....	58	LD-INEXT30W-64.....	128
LD-5630-300-65-ZB.....	405	LD-BNC15WKC-NB.....	180	LD-G4S1115-32.....	58	LD-INEXT30WP-64.....	128
LD-A60CM3-10W.....	37	LD-BNC15WOB-NB.....	180	LD-G4S1115-45.....	58	LD-INEXT50W-64.....	128
LD-A60CM4-10W.....	37	LD-BNC15WOC-NB.....	180	LD-G9P5WE0-30.....	50	LD-INEXT50WP-64.....	128
LD-A60CZ3-10W.....	37	LD-BNCC8WKB-NB.....	178	LD-G9P5WE0-40.....	50	LD-IRUSB-53.....	444
LD-A60CZ4-10W.....	37	LD-BNCC8WKC-NB.....	178	LD-G9P67W0-30.....	51	LD-J7805WCE-40.....	54
LD-A60FLE8-30.....	44	LD-BNCC8WOB-NB.....	178	LD-G9P67W0-40.....	51	LD-J7806WE-40.....	54
LD-A60FLE8-40.....	44	LD-BNCC8WOC-NB.....	178	LD-G9P95W0-30.....	51	LD-J11809WCE-40.....	55
LD-A60FLE8M-30.....	35	LD-BNCC16WOB2-NB.....	179	LD-G9P95W0-40.....	51	LD-J11810WE-40.....	54
LD-A60FLE8M-40.....	35	LD-BNCC16WOC2-NB.....	179	LD-G9PE35W-30.....	50	LD-JAS15W-40.....	174
LD-A60FP8-18.....	48	LD-BOS1CBWG-53.....	445	LD-G9PE35W-40.....	50	LD-KABE2M-00.....	394
LD-A60FPE8-30.....	48	LD-C35FEP4-30.....	32	LD-G45FLE2EM-30.....	41	LD-KABE2M-00.....	468
LD-AKO4060-NB.....	66	LD-C35FEP4-30L.....	32	LD-G45FLE2EM-40.....	42	LD-KABE2M-10.....	394
LD-AL24CB-53.....	440	LD-C35FLE4-30.....	31	LD-G45FLE4-30.....	31	LD-KALU100K-40.....	99
LD-AL24NE-53.....	440	LD-C35FLE4-30L.....	31	LD-G45FLE4-40.....	31	LD-KALU100W-40.....	99
LD-AL24ZB-53.....	440	LD-C35FLE4-40.....	31	LD-G45FLE4E-30.....	41	LD-KAN150W-NB.....	136
LD-ALCX10W-64.....	131	LD-C35FLE4-40L.....	31	LD-G45FLE4EM-40.....	42	LD-KAN200W-NB.....	136
LD-ALCX20W-64*.....	131	LD-C35FLE4M-30.....	26	LD-G45FLE4M-30.....	29	LD-KAR18W-CCT.....	124
LD-ALF100-27W.....	43	LD-C35FLE4M-30L.....	27	LD-G45FLE4M-40.....	29	LD-KAR25W-CCT.....	124
LD-ALF120-34W.....	43	LD-C35FLE4M-40.....	26	LD-G45FP4-18.....	32	LD-KAT400-00.....	247
LD-ALF140-43W.....	43	LD-C35FLE4M-40L.....	27	LD-G45FPE4-30.....	32	LD-KAT400-01.....	247
LD-AR111NW13W40-00.....	56	LD-C35FP4-18.....	32	LD-G93W25-32.....	50	LD-KAT400-10.....	247
LD-AR111NW13W40-10.....	56	LD-C35FP4-18L.....	32	LD-G93W25-45.....	50	LD-KAT600-00.....	247
LD-AR111NW13W120-00.....	56	LD-CANTH12WKW-40.....	274	LD-G93WE25-30.....	50	LD-KAT600-01.....	247
LD-AR111NW13W120-10.....	56	LD-CANTH12WOK-40.....	274	LD-G93WE25-40.....	50	LD-KAT600-10.....	247
LD-AR111WW13W40-00.....	56	LD-COB12V-20-CBN.....	408	LD-G95FEV4-30.....	46	LD-KDO8WOK-NB.....	103
LD-AR111WW13W40-10.....	56	LD-COB12V-20-CBPQ.....	408	LD-G95FLE8-30.....	44	LD-KDO8WOV-NB.....	103
LD-AR111WW13W120-00.....	56	LD-COB12V-20-NEN.....	408	LD-G95FLE8-40.....	44	LD-KD12WOK-NB.....	103
LD-AR111WW13W120-10.....	56	LD-COB12V-20-NEPQ.....	408	LD-G95FP8-18.....	48	LD-KD12WOV-NB.....	103
LD-ARC15W-NB.....	125	LD-COB12V-20-ZBN.....	408	LD-G95FPE8-30.....	48	LD-KLPCB-00N.....	445
LD-ARC25W-NB.....	125	LD-COB12V-20-ZBPQ.....	408	LD-G125FEV4-30.....	46	LD-KLPNB-00N.....	445
LD-ARC30W-NB.....	125	LD-COB24V-20-CBN.....	408	LD-G125FLE8-30.....	44	LD-KLPZB-00N.....	445
LD-ARG30W60-NB.....	72	LD-COB24V-20-NEN.....	408	LD-G125FLE8-40.....	44	LD-KNG45060-NB.....	72
LD-ARG40W60-NB.....	72	LD-COB24V-20-ZBN.....	408	LD-G125FP8-18.....	48	LD-KNG45312-NB.....	72
LD-ARG55W60-NB*.....	72	LD-CORSO1-00.....	144	LD-G125FPE8-30.....	48	LD-KONMINI-RGB.....	453
LD-ARZ18W-CCT.....	122	LD-CORSO3-00.....	144	LD-G935W04-30.....	50	LD-KONML-AD.....	456
LD-ARZ25W-CCT.....	122	LD-CS36CB-53.....	440	LD-G935W04-40.....	50	LD-KONML-MONO.....	454
LD-ARZ35W-CCT.....	122	LD-CS36NE-53.....	440	LD-G4018W-30.....	58	LD-KONML-MONO-PAN.....	454

LD-KONML-MONO-PIL.....	454	LD-MAW24W-CBP.....	109	LD-ORN24W-NBP-10.....	106	LD-R6380W-30.....	35
LD-KONML-RGBW.....	455	LD-MAW24W-CBP4.....	109	LD-ORW03W-CBP.....	107	LD-R6380W-40.....	35
LD-KONML-RGBW-PIL.....	455	LD-MAW24W-CBP-10.....	110	LD-ORW03W-CBP4.....	107	LD-RA60CB-40N.....	444
LD-KONML-WIFI.....	456	LD-MAW24W-NBP.....	109	LD-ORW03W-NBP.....	107	LD-RA60ZB-40N.....	444
LD-KONML-WRGB-PAN.....	455	LD-MAW24W-NBP4.....	109	LD-ORW03W-NBP4.....	107	LD-RGB-150-20.....	405
LD-KWP27CB-53.....	443	LD-MAW24W-NBP-10.....	110	LD-ORW07W-CBP.....	107	LD-RGB-150-65.....	405
LD-LIV40WNB-00.....	173	LD-MCR12W-NB.....	97	LD-ORW07W-CBP4.....	107	LD-RGBW-300-20.....	405
LD-LIV40WNB-10.....	173	LD-MISS7WKC-NB.....	273	LD-ORW07W-CBP-10.....	108	LD-SAHER1-DUO.....	143
LD-LNG24WB-NB.....	83	LD-MISS7WKS-NB.....	273	LD-ORW07W-NBP.....	107	LD-SAHER3-DUO.....	143
LD-LNG48WB-NB.....	83	LD-MISS7WOC-NB.....	273	LD-ORW07W-NBP4I.....	107	LD-SATU12WM-NB.....	91
LD-LOG16W-LED.....	96	LD-MISS7WOS-NB.....	273	LD-ORW07W-NBP-10.....	108	LD-SATU12W-NW-00.....	90
LD-LSNK06W-NB.....	112	LD-MOD4060-NB.....	68	LD-ORW13W-CBP.....	107	LD-SATU18WM-NB.....	91
LD-LSNK12W-NB.....	112	LD-MOD4060UGR-NB.....	68	LD-ORW13W-CBP4.....	107	LD-SATU18W-NW-00.....	90
LD-LSNK24W-NB.....	112	LD-MOD12030UGR-NB.....	68	LD-ORW13W-CBP-10.....	108	LD-SATU24WM-NB.....	91
LD-LSNO06W-NB.....	112	LD-MOON12W-NB.....	88	LD-ORW13W-NBP.....	107	LD-SATU24W-NW-00.....	90
LD-LSNO12W-NB.....	112	LD-MOON18W-NB.....	88	LD-ORW13W-NBP4.....	107	LD-SATU32W-NW-00.....	90
LD-LSNO24W-NB.....	112	LD-MZ12WKW-NB.....	111	LD-ORW13W-NBP-10.....	108	LD-SATU48W-NW-00.....	90
LD-LSWK03W-NB.....	114	LD-MZ12WOK-NB.....	111	LD-ORW19W-CBP.....	107	LD-SILVAGU10D-20.....	280
LD-LSWK06W-NB.....	114	LD-MZ18WKW-NB.....	111	LD-ORW19W-CBP4.....	107	LD-SILVAGU10D-80.....	280
LD-LSWK15W-NB.....	114	LD-MZ18WOK-NB.....	111	LD-ORW19W-CBP-10.....	108	LD-SILVAGU10J-20.....	280
LD-LSWK24W-NB.....	114	LD-NESSAGU10D-20.....	278	LD-ORW19W-NBP.....	107	LD-SILVAGU10J-80.....	280
LD-LSWO03W-NB.....	114	LD-NESSAGU10D-80.....	278	LD-ORW19W-NBP4.....	107	LD-SM1210-10.....	53
LD-LSWO06W-NB.....	114	LD-NESSAGU10J-20.....	278	LD-ORW19W-NBP-10.....	108	LD-SM1210N-10.....	53
LD-LSWO15W-NB.....	114	LD-NESSAGU10J-80.....	278	LD-ORW24W-CBP.....	107	LD-SM1210Z-10.....	53
LD-LSWO24W-NB.....	114	LD-NF-12V6x12-65-CB.....	409	LD-ORW24W-CBP4.....	107	LD-SM4016-30.....	57
LD-LU16CB-53.....	439	LD-NF-12V6x12-65-NE.....	409	LD-ORW24W-CBP-10.....	108	LD-SM4016-40.....	57
LD-LU16NE-53.....	439	LD-NF-12V6x12-65-ZB.....	409	LD-ORW24W-NBP.....	107	LD-SM4016-64.....	57
LD-LU16ZB-53.....	439	LD-NGU10P-1W.....	52	LD-ORW24W-NBP4.....	107	LD-SM6016-30.....	57
LD-LUM120-30P.....	82	LD-NGU10P-3W.....	52	LD-ORW24W-NBP-10.....	108	LD-SM6016-40.....	57
LD-LUM150-30P.....	82	LD-NGU10P-4W.....	52	LD-OSA16WD-40.....	93	LD-SM6016-64.....	57
LD-LUN40WNB-00-A.....	172	LD-NGU10P-4W.....	52	LD-OSA22WD-40.....	93	LD-SMB45B-10.....	29
LD-LUN40WNB-10-A.....	172	LD-NGU10PN-1W.....	52	LD-OXCX10W-64.....	131	LD-SMB45B-80.....	28
LD-LUNAR60-40.....	78	LD-NGU10PN-3W.....	52	LD-OXCX20W-64.....	131	LD-SMBD45-10.....	42
LD-LUNAR120-80.....	78	LD-NGU10PN-4W.....	52	LD-OZE218-00.....	151	LD-SMBD45-80.....	41
LD-MA24063-NB.....	70	LD-NGU10PZ-1W.....	52	LD-OZE218-01.....	151	LD-SMBKW07W-21.....	115
LD-MA40060-NB.....	70	LD-NGU10PZ-3W.....	52	LD-OZE236-00.....	151	LD-SMBKW14W-21.....	115
LD-MA40312-NB.....	70	LD-NGU10PZ-4W.....	52	LD-OZE236-01.....	151	LD-SMBKW24W-21.....	115
LD-MAN07W-CBP.....	108	LD-OBP27CB-53.....	443	LD-OZE236-01.....	151	LD-SMBK07W-21.....	115
LD-MAN07W-CBP-10.....	110	LD-OBP27ZB-53.....	443	LD-PAR10W40-00.....	276	LD-SMBK14W-21.....	115
LD-MAN07W-NBP.....	108	LD-OGLA3W-00.....	145	LD-PAR10W40-10.....	276	LD-SMBOK14W-21.....	115
LD-MAN07W-NBP-10.....	110	LD-OGLA3W-10.....	145	LD-PAR10W40BC-00.....	276	LD-SMBOK20W-21.....	115
LD-MAN13W-CBP.....	108	LD-OLL20W-CB.....	84	LD-PAR10W40BC-10.....	276	LD-SMC37L-10.....	28
LD-MAN13W-CBP-10.....	110	LD-OLL20W-NB.....	84	LD-PARK3L30W-40.....	139	LD-SMC37L-80.....	27
LD-MAN13W-NBP.....	108	LD-OLL40W-CB.....	84	LD-PARK3L50W-40.....	139	LD-SMDC37-80.....	26
LD-MAN13W-NBP-10.....	110	LD-OLL40W-NB.....	84	LD-PARK3L80W-40.....	139	LD-SMGB45B-30.....	28
LD-MAN19W-CBP.....	108	LD-OLL50W-CB.....	84	LD-PC2A60-6W.....	35	LD-SMGB45B-60*.....	28
LD-MAN19W-CBP-10.....	110	LD-OLL50W-NB.....	84	LD-PC2A60-8W.....	33	LD-SMGB45C-30.....	41
LD-MAN19W-NBP.....	108	LD-OMAH33-00.....	145	LD-PC2A60-12.....	33	LD-SMGB45C-60.....	41
LD-MAN19W-NBP-10.....	110	LD-OME30WNB-10-L.....	170	LD-PC2A60-15W.....	34	LD-SMGC30B-30.....	26
LD-MAN24W-CBP.....	108	LD-OME30WNB-10-T.....	170	LD-PC2A60RGBW-10W.....	37	LD-SMGC30B-60*.....	26
LD-MAN24W-CBP-10.....	110	LD-OME50WNB-10-A*.....	170	LD-PC3A60-10W.....	33	LD-SMGC30C-30.....	39
LD-MAN24W-NBP.....	108	LD-OME50WNB-10-C.....	170	LD-PC3A60-15W.....	34	LD-SMGC30C-60.....	39
LD-MAN24W-NBP-10.....	110	LD-OMN060-30B.....	81	LD-PC3A65-18W.....	34	LD-SMGC30L-30.....	27
LD-MAW03W-CBP.....	109	LD-OMN120-60B.....	81	LD-PC4A65-20W.....	34	LD-SMGC30L-60.....	27
LD-MAW03W-CBP4.....	109	LD-OMN120B-75M.....	81	LD-PC6010-30.....	52	LD-SMNB45B-10.....	29
LD-MAW03W-NBP.....	109	LD-OMN150-70B.....	81	LD-PC6010-40.....	52	LD-SMNB45B-80.....	28
LD-MAW03W-NBP4.....	109	LD-OMN150B-90M.....	81	LD-PC6010-64.....	52	LD-SMNB45-10.....	42
LD-MAW07W-CBP.....	109	LD-ONT120-36.....	84	LD-PC7510-30.....	52	LD-SMNB45-80.....	41
LD-MAW07W-CBP4.....	109	LD-ONTEND-00.....	85	LD-PC7510-40.....	52	LD-SMNC37L-10.....	28
LD-MAW07W-NBP.....	109	LD-ONTMCI-00.....	85	LD-PC7510-64.....	52	LD-SMNC37L-80.....	27
LD-MAW07W-NBP4.....	109	LD-ONTPWR-00.....	85	LD-PIRUSB-53.....	444	LD-SMNC37-80.....	26
LD-MAW07W-NBP-10.....	110	LD-ORN07W-CBP.....	106	LD-PN2A60-8W.....	33	LD-SMNC37-80.....	26
LD-MAW07W-NBP4.....	109	LD-ORN07W-CBP-10.....	106	LD-PN2A60-12.....	33	LD-SMNC37-80.....	26
LD-MAW13W-CBP.....	109	LD-ORN07W-NBP.....	106	LD-PN3A60-10W.....	33	LD-SMNC37-80.....	26
LD-MAW13W-CBP4.....	109	LD-ORN07W-NBP-10.....	106	LD-PN3A60-15W.....	34	LD-SMNC37-80.....	26
LD-MAW13W-NBP.....	109	LD-ORN13W-CBP.....	106	LD-PN3A60-15W.....	34	LD-SMNC37-80.....	26
LD-MAW13W-NBP4.....	109	LD-ORN13W-CBP-10.....	106	LD-PN3A65-18W.....	34	LD-SMNC37-80.....	26
LD-MAW19W-CBP.....	109	LD-ORN13W-NBP.....	106	LD-PN4A65-20W.....	34	LD-SMNC37-80.....	26
LD-MAW19W-CBP-10.....	110	LD-ORN19W-CBP.....	106	LD-PRM10WB-NB.....	175	LD-SMNC37-80.....	26
LD-MAW19W-NBP.....	109	LD-ORN19W-CBP-10.....	106	LD-PRM10WC-NB.....	175	LD-SMNC37-80.....	26
LD-MAW19W-NBP4.....	109	LD-ORN24W-CBP.....	106	LD-PRM10WS-NB.....	175	LD-SMNC37-80.....	26
LD-MAW19W-NBP-10.....	110	LD-ORN24W-CBP-10.....	106	LD-PZ2A60-12.....	33	LD-SMNC37-80.....	26
LD-MAW19W-NBP4.....	109	LD-ORN24W-NBP.....	106	LD-PZ3A60-10W.....	33	LD-SMNC37-80.....	26
LD-MAW19W-NBP-10.....	110	LD-ORN24W-NBP-10.....	106	LD-PZ3A60-15W.....	34	LD-SMNC37-80.....	26
LD-MAW19W-NBP4.....	109	LD-ORN24W-NBP-10.....	106	LD-PZ3A65-18W.....	34	LD-SMNC37-80.....	26
LD-MAW19W-NBP-10.....	110	LD-ORN24W-NBP-10.....	106	LD-PZ4A65-20W.....	34	LD-SMNC37-80.....	26
LD-MAW19W-NBP4.....	109	LD-ORN24W-NBP-10.....	106	LD-R5060W-30.....	30	LD-SMNC37-80.....	26
LD-MAW19W-NBP-10.....	110	LD-ORN24W-NBP-10.....	106	LD-R5060W-40.....	30	LD-SMNC37-80.....	26

LD-SMZGB45C-30.....	41	LD-VALLA12W-40.....	272	LD-ZWND6W-10.....	452	OP-CANOKB-10.....	230
LD-SMZGB45C-60.....	41	LD-VE15CB-53N.....	441	LD-ZWND12-10.....	452	OP-CANOKC-00.....	230
LD-SMZGC30B-30.....	26	LD-VE15CBZB-53N.....	441	LD-ZZAS07PROKD6.....	449	OP-ELVAOBB-10.....	239
LD-SMZGC30B-60*.....	26	LD-VE15NE-53N.....	441	LD-ZZAS12PROKD6.....	449	OP-ELVAOBC-11.....	239
LD-SMZGC30C-30.....	39	LD-VE15ZB-53N.....	441	LD-ZZAS16PROKD6.....	449	OP-ELVAOBM-13.....	239
LD-SMZGC30C-60.....	39	LD-VIL42WUDB-NB.....	173	LD-ZZAS24PROKD6.....	449	OP-ELVAOCC-00.....	239
LD-SMZGC30L-30.....	27	LD-VIL42WUDC-NB.....	173	LD-ZZAS33PROKD6.....	449	OP-ELVAOCM-03.....	239
LD-SMZGC30L-60.....	27	LD-VIPERS30W-40.....	127	LD-ZZASG18KWD6.....	452	OP-KERLKW-00.....	238
LD-SOL36W40-NB.....	66	LD-VIPERS50W-40.....	127	LK-LIVIA-OP.....	173	OP-KERLKW-10.....	238
LD-SPCA60-10W.....	39	LD-VIPERS100W-40.....	127	LK-OMEGA-OP.....	170	OP-LINTOK-00.....	238
LD-SPCGU10-7W.....	51	LD-VIPERS150W-40.....	127	LK-PANELX4-00.....	74	OP-LINTOK-10.....	238
LD-SPNA60-10W.....	39	LD-VLRKW0538-CB.....	120	LK-VILANA-00.....	173	OP-LINTOK-52.....	238
LD-SPNGU10-7W.....	51	LD-VLRKW0538-NB.....	120	LP-BENFICA2-00.....	312	OP-MAROK-02.....	234
LD-SRA08WB-NB.....	182	LD-VLRKW0738-CCT.....	121	LP-BENFICA2-10.....	312	OP-MAROK-10.....	234
LD-SRA08WC-NB.....	182	LD-VLRKW1038-CB.....	120	LP-BENFICA2-80.....	312	OP-OPRKW1-20.....	229
LD-SRA18WB-NB.....	182	LD-VLRKW1038-NB.....	120	LP-VAS8W-10-DEC.....	308	OP-OPRKW1-80.....	229
LD-SRA18WC-NB.....	182	LD-VLROK0538-CB.....	120	LP-VEN20W-10.....	313	OP-OPRKWT-10.....	228
LD-SRW12WKW-NB.....	105	LD-VLROK0538-NB.....	120	LP-VEN20WO-00.....	313	OP-OPRKWT-21.....	228
LD-SRW12WOK-NB.....	105	LD-VLROK0738-CCT.....	121	LP-YORK10W-00-DEC.....	310	OP-OPROK1-20.....	229
LD-SRW18WKW-NB.....	105	LD-VLROK1038-CB.....	120	LP-YORK10W-10-DEC.....	310	OP-OPROK1-80.....	229
LD-SRW18WOK-NB.....	105	LD-VLROK1038-NB.....	120	LT-LA8WT2-60.....	165	OP-OPROK1-10.....	228
LD-SRW24WKW-NB.....	105	LD-WZA20W-NW.....	451	LT-LB3WT4-60.....	165	OP-OPROKR-21.....	228
LD-SRW24WOK-NB.....	105	LD-WZA36W-NW.....	451	LT-LB6WT2-60.....	164	OP-PADRK3-01.....	223
LD-ST64FLE6-30.....	45	LD-WZA60W-NW.....	451	LT-LB8WT6-60.....	165	OP-PADRK3-10.....	223
LD-ST64FLE6-40.....	45	LD-WZA80W-NW.....	451	LT-LC6WT3-60.....	163	OP-PADRK3-21.....	223
LD-ST64FP4-18.....	49	LD-WZA150W-NW.....	451	LT-LK3WBL-60.....	164	OP-PADRK3-52.....	223
LD-ST64FPE6-30.....	49	LD-XARO18W-30.....	80	LT-LKSZ3W-60.....	164	OP-PADRK3-61.....	223
LD-ST64FVE4-30.....	46	LD-XARO36W-30.....	80	LZ-25MM00-00.....	391	OP-PADST3-01.....	222
LD-STAR24W-NW-00.....	88	LD-XARO48W-30.....	80	LZ-40MM00-00.....	391	OP-PADST3-10.....	222
LD-STAR48W-NW-00.....	88	LD-Z3CSCB-53.....	442	LZ-60MM00-00.....	391	OP-PADST3-21.....	222
LD-STEL080W-40.....	140	LD-ZAC6WDE-RGB.....	453	LZ-100MM00-00.....	391	OP-PADST3-52.....	222
LD-STEL150W-40.....	140	LD-ZAS09WEC-30.....	447	LZ-160MM00-00.....	391	OP-PADST3-61.....	222
LD-SZ30W10-30.....	53	LD-ZAS15WEC-30.....	447	LZ-250MM00-00.....	391	OP-PALACEDKW-10.....	232
LD-SZ30W10-40.....	53	LD-ZAS20WEC-30.....	447	LZ-AKZ312-10N.....	469	OP-PALACEDKW-20.....	232
LD-SZ30W10-64.....	53	LD-ZAS24PRO16W-30.....	448	LZ-AKZ612-10N.....	470	OP-PALACEDOK-10.....	232
LD-SZ50W10-30.....	53	LD-ZAS24PRO33W-30.....	448	LZ-KA2MM-10.....	468	OP-PALACEDOK-20.....	232
LD-SZ50W10-40.....	53	LD-ZAS24PRO54W-30.....	448	LZ-KAPR2M-10.....	469	OP-PAST1-01.....	221
LD-SZ50W10-64.....	53	LD-ZAS24PRO80W-30.....	448	LZ-KOI2KO-10.....	391	OP-PAST1-02.....	221
LD-SZ70W10-30.....	53	LD-ZAS30WEC-30.....	447			OP-PAST1-10.....	221
LD-SZ70W10-40.....	53	LD-ZAS60WEC-30.....	447			OP-PAST1-21.....	221
LD-SZ70W10-64.....	53	LD-ZAS75W-30.....	448			OP-PAST1-30.....	221
LD-SZ1510-30.....	52	LD-ZAS150-NW.....	450	O		OP-PIREN1-00.....	214
LD-SZ1510-40.....	52	LD-ZAS350-NW.....	450	OA-MALEDPAN-00.....	397	OP-PIREN1-20.....	214
LD-SZ1510-64.....	52	LD-ZASNF-12V6X12-65.....	409	OA-MALED1-08.....	144	OP-PIREN1-00.....	214
LD-SZ5010-30.....	53	LD-ZASPRO07W-30.....	449	OA-MALED3-08.....	144	OP-PIREN2-00.....	214
LD-SZ5010-40.....	53	LD-ZASPRO12W-30.....	449	OH-ST2500-23.....	393	OP-PIREN2-20.....	214
LD-SZ5010-64.....	53	LD-ZASPRO16W-30.....	449	ON-ALFAKGU10-06.....	291	OP-PIREO1-20.....	217
LD-TERNO1-00.....	143	LD-ZASPRO16W-30.....	449	ON-ALFAKGU10-06-MINI.....	291	OP-PIREO1-81.....	217
LD-TERNO3-00.....	143	LD-ZASPRO24W-30.....	449	ON-ALFAO-C1W.....	292	OP-PIREO2-20.....	217
LD-TIAGOGU10D-01.....	284	LD-ZASPRO24W-30.....	449	ON-ALFAO-C2W.....	292	OP-PIREO2-81.....	217
LD-TIAGOGU10D-01KW.....	282	LD-ZASPRO33W-30.....	449	ON-ALFAOGU10-06.....	291	OP-PRAN5-01.....	226
LD-TIAGOGU10D-20.....	284	LD-ZASPRO54W-30.....	449	ON-ALFAOGU10-06-MINI.....	291	OP-PRAN5-02.....	226
LD-TIAGOGU10D-20KW.....	282	LD-ZASPRO65W-30.....	449	ON-BETAKGU10RK-06.....	292	OP-PRAN5-21.....	226
LD-TIAGOGU10J-01.....	284	LD-ZASPRO80W-30.....	449	ON-BETAOGU10RK-06.....	292	OP-PRAN5-30.....	226
LD-TIAGOGU10J-01KW.....	282	LD-ZASPU15W-30N.....	451	OP-ALSKW-00.....	240	OP-PRAN6-01.....	227
LD-TIAGOGU10J-20.....	284	LD-ZFPL24W06-NB.....	83	OP-ALSKW-10.....	240	OP-PRAN6-02.....	227
LD-TIAGOGU10J-20KW.....	282	LD-ZFPL48W12-NB.....	83	OP-ALSKW-52.....	240	OP-PRAN6-21.....	227
LD-TK100W-40.....	133	LD-ZIT600W-00.....	175	OP-ALSOK-00.....	240	OP-PRAN6-30.....	227
LD-TOK16WD-40.....	93	LD-ZIT600W-01.....	175	OP-ALSOK-10.....	240	OP-PROD3-01.....	224
LD-TOK16WP-40.....	92	LD-ZLSRGB150-00.....	407	OP-ALSOK-52.....	240	OP-PROD3-02.....	224
LD-TOK22W-40.....	92	LD-ZSKL15-00N.....	452	OP-ARIKW-11.....	235	OP-PROD3-21.....	224
LD-TOK22WD-40.....	93	LD-ZTK8-COB.....	470	OP-ARIKW-13.....	235	OP-PROD3-30.....	224
LD-TR24CB-53.....	442	LD-ZTK8MM-02N600.....	472	OP-ARIKW-22.....	235	OP-PROD4-01.....	225
LD-TR24NE-53.....	442	LD-ZTK10MM-02N.....	472	OP-ARIKW-23.....	235	OP-PROD4-02.....	225
LD-TR24ZB-53.....	442	LD-ZTKS8MM-02N.....	472	OP-ARIOK-11.....	235	OP-PROD4-21.....	225
LD-TWI10WOK-40.....	100	LD-ZTKT8MM-02N600.....	471	OP-ARIOK-13.....	235	OP-PROD4-30.....	225
LD-TWI10WOW-40.....	100	LD-ZTKT10MM-02N.....	471	OP-ARIOK-22.....	235	OP-RUBIOKW1-00.....	242
LD-TWN09W-CB.....	118	LD-ZTKTRGB-04N.....	471	OP-ARIOK-23.....	235	OP-RUBIOKW1-10.....	242
LD-TWN16W-CB.....	118	LD-ZTL8-COB.....	470	OP-AURKW-10.....	236	OP-RUBIOKW2-00.....	242
LD-TWW09W-CB.....	118	LD-ZTL8MM-02N600.....	471	OP-AURKW-52.....	236	OP-RUBIOKW2-10.....	242
LD-TWW16W-CB.....	118	LD-ZTL82MAMP-COB.....	470	OP-AUROKB-10.....	236	OP-SALKW-10.....	231
LD-UNF-12V6X12-6X.....	409	LD-ZTL82M-COB.....	470	OP-AUROK-00.....	236	OP-SALOK-10.....	231
LD-VA24CB-53.....	439	LD-ZTLRGB-04N.....	471	OP-AUROK-00.....	236	OS-AERD20W-00.....	188
LD-VA24NE-53.....	439	LD-ZTL8MM-02N.....	472	OP-AUROK-00.....	236	OS-AERD20W-10.....	188
LD-VALLA8W-40.....	272	LD-ZTLS8MM-02N.....	472	OP-AUROK-00.....	236	OS-ARIKW-11.....	200
		LD-ZTLS8MAMP-02N.....	472	OP-AUROK-00.....	236	OS-ARIKW-13.....	200
		LD-ZTLS82M-2N.....	472				

OS-ARIKW-22.....	200
OS-ARIKW-23.....	200
OS-ARIOK-11.....	200
OS-ARIOK-13.....	200
OS-ARIOK-22.....	200
OS-ARIOK-23.....	200
OS-ASTRITE27-20.....	266
OS-ASTRITE27-80.....	266
OS-AVB8090KW1-00.....	190
OS-AVB8090KW1-10.....	190
OS-AVB8090OK1-00.....	190
OS-AVB8090OK1-10.....	190
OS-AVB80160KW2-00.....	192
OS-AVB80160KW2-10.....	192
OS-AVB80160OK2-00.....	192
OS-AVB80160OK2-10.....	192
OS-BLND50W1-00.....	202
OS-BLND50W1-10.....	202
OS-BLND50W2-00.....	203
OS-BLND50W2-10.....	203
OS-BLND50W3-00.....	203
OS-BLND50W3-10.....	203
OS-CAMD40WG9KW-00.....	218
OS-CAMD40WG9KW-10.....	218
OS-CAMD40WG9OK-00.....	218
OS-CAMD40WG9OK-10.....	218
OS-COROUA-30.....	250
OS-CORDUA-30.....	250
OS-CORP36G-30.....	250
OS-CORP40-30.....	250
OS-CORP40G-30.....	250
OS-CORP80-30.....	250
OS-CORP80G-30.....	250
OS-DIEGOGU10-20.....	288
OS-DIEGOGU10-80.....	288
OS-DRAGO14-00.....	201
OS-DRAGO14-10.....	201
OS-DRAGO14-80.....	201
OS-DRAGO18-00.....	201
OS-DRAGO18-10.....	201
OS-DRAGO18-80.....	201
OS-ESOE2711-20.....	268
OS-ESOE2711-80.....	268
OS-FRG20W2-00.....	204
OS-FRG20W2-00-MINI.....	204
OS-FRG20W2-10.....	204
OS-FRG20W2-10-MINI.....	204
OS-GRA0DA-00.....	262
OS-GRA00P-00.....	262
OS-GRA0UA-00.....	262
OS-GRA31P-00.....	262
OS-GRAZIEGU10-01.....	290
OS-GRAZIEGU10-20.....	290
OS-HERZW1-00.....	153
OS-IBBL060-00.....	157
OS-IBKR060-00.....	157
OS-ISUES111-00.....	216
OS-ISUES111-10.....	216
OS-ITL12WKW-LED.....	98
OS-ITL12W-LED.....	98
OS-ITL16W-LED.....	98
OS-KACROO-00.....	158
OS-KAG508-10.....	163
OS-KAM060-00.....	160
OS-KAM060-10.....	160
OS-KAN527-24.....	163
OS-KAY060-00.....	160
OS-KAY060-10.....	160
OS-KEMIOUA-30.....	254
OS-KEMIP40-30.....	254
OS-KEMIP40G-30*.....	254
OS-KEMIP80-30.....	254
OS-KERTOUA-30.....	252
OS-KERTP40-30.....	252
OS-KERTP80-30.....	252

OS-LAGD20W-00.....	189
OS-LAGD20W-10.....	189
OS-LARG0UA-30.....	258
OS-LARGP36G-30.....	258
OS-LARGP40-30.....	258
OS-LARGP40G-30.....	258
OS-LARGP40P-30*.....	258
OS-LARGP80-30.....	258
OS-LE150NJ-01.....	148
OS-LEN100KWG-30.....	270
OS-LEN100OKG-30.....	270
OS-LUP-2GU10-00.....	212
OS-LUP-2GU10-10.....	212
OS-LUP-GU10-00.....	212
OS-LUP-GU10-10.....	212
OS-MARINADA-00.....	264
OS-MARINAH-00.....	264
OS-MARINAP-00.....	264
OS-MARINAP3-00.....	264
OS-MARINAUA-00.....	264
OS-MARMO25-00.....	289
OS-MARMO28-00.....	289
OS-MARMO38-00.....	289
OS-MED0AU-30.....	256
OS-MED0AUP-30*.....	256
OS-MEDP50-30.....	256
OS-MEDP50P-30*.....	256
OS-MILA00A-00.....	249
OS-MILA00U-00.....	249
OS-MILA10P-00.....	249
OS-MILA45P-00.....	249
OS-NSSEL118-00.....	395
OS-NSSEL136-00.....	395
OS-NSSEL158-00.....	395
OS-ORI-2GU10-00.....	210
OS-ORI-2GU10-10.....	210
OS-ORI-3GU10-00.....	211
OS-ORI-3GU10-10.....	211
OS-ORI-GU10-00.....	210
OS-ORI-GU10-10.....	210
OS-OSL1120S-00.....	147
OS-OSL1150S-00.....	147
OS-OSL2120S-00.....	147
OS-OSL2150S-00.....	147
OS-PLCRKM-00.....	155
OS-PLCRKZ-00.....	155
OS-PLCZMI-00.....	156
OS-PLCZOO-00.....	156
OS-REN20WKW1-00.....	206
OS-REN20WKW1-10.....	206
OS-REN20WKW2-00.....	206
OS-REN20WKW2-10.....	206
OS-RINGO1-00.....	158
OS-RIV102KWG-30.....	271
OS-RIV102OKG-30.....	271
OS-RST8080KW1-00.....	198
OS-RST8080KW1-10.....	198
OS-RST80125OK1-00.....	198
OS-RST80125OK1-10.....	198
OS-SAKES111-00.....	213
OS-SAKES111-10.....	213
OS-SAKES111KW-00.....	213
OS-SAKES111KW-10.....	213
OS-SAN20WOK1B-00.....	205
OS-SAN20WOK1B-10.....	205
OS-SAN20WOK2B-00.....	205
OS-SAN20WOK2B-10.....	205
OS-SEL236-ZHQ.....	395
OS-SEL418-ZHQ.....	395
OS-SEN5087OKB-10.....	196
OS-SEN5087OKCZ-00.....	196
OS-SEN5097KWB-10.....	196
OS-SEN5097KWCZ-00.....	196
OS-SENAQ5087OKB-10.....	197
OS-SENAQ5087OKB-80.....	197

OS-SENAQ5087OKCZ-00.....	197
OS-SEND5083OKB-10.....	197
OS-SEND5083OKCZ-00.....	197
OS-SENM5081OKB-10.....	194
OS-SENM5081OKCZ-00.....	194
OS-SENM5091KWB-10.....	194
OS-SENM5091KWCZ-00.....	194
OS-STA422-00.....	394
OS-STA465-00.....	394
OS-TENGU10-00.....	186
OS-TENGU10-10.....	186
OS-TENGU10KW-00.....	186
OS-TENGU10KW-10.....	186
OS-TMG30CM-00.....	264
OS-TOR0AU-00.....	260
OS-TORP50-00.....	260
OS-TORP80-00.....	260
OS-TOS0DA-00.....	266
OS-TOS0DA-80.....	266
OS-TRESID320W-00.....	189
OS-TRESID320W-10.....	189
OS-USTI0UD-30.....	261
OS-USTIP40-30.....	261
OS-USTIP80-30.....	261
OS-VEN20WO1-00.....	207
OS-VEN20WO1-10.....	207
OS-VEN20WO2-00.....	207
OS-VEN20WO2-10.....	207
OS-VEN20WO3-00.....	208
OS-VEN20WO3-10.....	208
OS-VEN20WO4-00.....	208
OS-VEN20WO4-10.....	208
OS-VEN20WO5-00.....	209
OS-VEN20WO5-10.....	209
OS-VEN20WOK4-00.....	209
OS-VEN20WOK4-10.....	209
OS-VENTANAH-00.....	268
OS-VENTANAUA-00.....	268

P

PA-CPGLAXAH-00.....	410
PA-CPGLAXAH-00.....	412
PA-CPGLAXAH-00.....	414
PA-CPGLAXAH-00.....	416
PA-CPGLAXAH-00.....	417
PA-CPGLAXAV-00.....	410
PA-CPGLAXAV-00.....	412
PA-CPGLAXAV-00.....	414
PA-CPGLAXAV-00.....	416
PA-CPGLAXAV-00.....	417
PA-CPGLAXL-00.....	410
PA-CPGLAXL-00.....	412
PA-CPGLAXL-00.....	414
PA-CPGLAXL-00.....	416
PA-CPGLAXL-00.....	417
PA-GLAX3M-AL.....	424
PA-GLAX3M-AL-10.....	424
PA-GLAX3M-AL-20M.....	424
PA-GLAX-AL.....	424
PA-GLAX-AL-10.....	424
PA-GLAX-AL-20M.....	424
PA-GLAX-AL-90.....	424
PA-GLAXDR-AL.....	426
PA-GLAXGKL3M-00C.....	410
PA-GLAXGKS3M-00C.....	412
PA-GLAXGKW3M-00C.....	414
PA-GLAXGKWK3M-00C.....	416
PA-GLAXGKZK3M-00C.....	417
PA-GLAXKT3M-AL.....	434
PA-GLAXKT-AL.....	434
PA-GLAXMIC3M-AL.....	423
PA-GLAXMIC-AL.....	423
PA-GLAXMICNK3M-AL.....	418
PA-GLAXMICNK-AL.....	418

PA-GLAXMNBW3M19-AL.....	430
PA-GLAXMNBW3M-AL.....	430
PA-GLAXMNBW3M19-AL.....	430
PA-GLAXMNBW3M-AL.....	430
PA-GLAXMNBW3M-AL.....	420
PA-GLAXMNBW3M-AL-10.....	420
PA-GLAXMNBW3M-AL-20M.....	420
PA-GLAXMNBW3M-AL.....	420
PA-GLAXMNBW3M-AL-10.....	420
PA-GLAXMNBW3M-AL-20M.....	420
PA-GLAXMNBW3M-AL-90.....	420
PA-GLAXMNBW3M-AL.....	422
PA-GLAXMNBW3M-AL-10.....	422
PA-GLAXMNBW3M-AL-20M.....	422
PA-GLAXMNBW3M-AL-90.....	422
PA-GLAXMPK-AL.....	431
PA-GLAXMW-AL.....	425
PA-GLAXMW-AL-10.....	425
PA-GLAXMW-AL-20M.....	425
PA-GLAXMW-AL-90.....	425
PA-GLAXMNB3M16-AL.....	433
PA-GLAXMNB3M19-AL.....	433
PA-GLAXMNB3M-AL.....	433
PA-GLAXMNBW3M16-AL.....	433
PA-GLAXMNBW3M19-AL.....	433
PA-GLAXMNBW3M-AL.....	433
PA-GLAXMNBW3M16-AL.....	432
PA-GLAXMNB3M19-AL.....	432
PA-GLAXMNB3M-AL.....	432
PA-GLAXMNBW3M16-AL.....	432
PA-GLAXMNBW3M19-AL.....	432
PA-GLAXMNBW3M-AL.....	432
PA-GLAXMNBW3M-AL.....	421
PA-GLAXNK-AL.....	421
PA-GLAXNKKT3M-AL.....	429
PA-GLAXNKKT3M-AL-10.....	429
PA-GLAXNKKT3M-AL-20M.....	429
PA-GLAXNKKT-AL.....	429
PA-GLAXNKKT-AL-10.....	429
PA-GLAXNKKT-AL-20M.....	429
PA-GLAXNKKT-AL-90.....	429
PA-GLAXRAD-AL.....	427
PA-GLAXREG1-AL.....	431
PA-GLAXREG2-AL.....	431
PA-GLAXWN3M-AL.....	428
PA-GLAXWN3M-AL-06.....	428
PA-GLAXWN3M-AL-10.....	428
PA-GLAXWN3M-AL-20M.....	428
PA-GLAXWN16-AL.....	428
PA-GLAXWN19-AL.....	428
PA-GLAXWN-AL.....	428
PA-GLAXWPKT-AL.....	434
PA-OSCLGLAX-00.....	424
PA-OSCLGLAX-00.....	428
PA-OSCLGLAX-00.....	429
PA-OSCLGLAX3M-00.....	424
PA-OSCLGLAX3M-00.....	428
PA-OSCLGLAX3M-00.....	429
PA-OSCLGLAXM-00.....	420
PA-OSCLGLAXM-00.....	422
PA-OSCLGLAXM-00.....	425
PA-OSCLGLAXM3M-00.....	410
PA-OSCLGLAXM3M-00.....	412
PA-OSCLGLAXM3M-00.....	414
PA-OSCLGLAXM3M-00.....	416
PA-OSCLGLAXM3M-00.....	417
PA-OSCLGLAXM3M-00.....	420
PA-OSMLGLAX-00.....	421
PA-OSMLGLAX-00.....	424
PA-OSMLGLAX-00.....	426
PA-OSMLGLAX-00.....	427
PA-OSMLGLAX-00.....	428
PA-OSMLGLAX-00.....	429
PA-OSMLGLAX-00.....	431
PA-OSMLGLAX-00.....	434

PA-OSMLGLAX-00.....	434
PA-OSMLGLAX3M-00.....	421
PA-OSMLGLAX3M-00.....	424
PA-OSMLGLAX3M-00.....	428
PA-OSMLGLAX3M-00.....	429
PA-OSMLGLAX3M-00.....	432
PA-OSMLGLAX3M-00.....	432
PA-OSMLGLAX3M-00.....	433
PA-OSMLGLAX3M-00.....	433
PA-OSMLGLAX3M-00.....	434
PA-OSMLGLAXM-00.....	420
PA-OSMLGLAXM-00.....	422
PA-OSMLGLAXM-00.....	425
PA-OSMLGLAXM-00.....	431
PA-OSMLGLAXM3M-00.....	410
PA-OSMLGLAXM3M-00.....	412
PA-OSMLGLAXM3M-00.....	414
PA-OSMLGLAXM3M-00.....	416
PA-OSMLGLAXM3M-00.....	417
PA-OSMLGLAXM3M-00.....	420
PA-OSMLGLAXM3M-00.....	430
PA-OSMLGLAXM3M-00.....	430
PA-OSMLGLAXMIC-00N.....	418
PA-OSMLGLAXMIC-00N.....	423
PA-OSMLGLAXMIC3M-00N.....	418
PA-OSMLGLAXMIC3M-00N.....	423
PA-OSMLGLAXMK-00.....	420
PA-OSMLGLAXMK-00.....	425
PA-OSMLGLAXMK3M-00.....	410
PA-OSMLGLAXMK3M-00.....	412
PA-OSMLGLAXMK3M-00.....	414
PA-OSMLGLAXMK3M-00.....	416
PA-OSMLGLAXMK3M-00.....	417
PA-OSMLGLAXMO-00.....	420
PA-OSMLGLAXMO3M-00.....	410
PA-OSMLGLAXMO3M-00.....	412
PA-OSMLGLAXMO3M-00.....	414
PA-OSMLGLAXMO3M-00.....	416
PA-OSMLGLAXMO3M-00.....	417
PA-OSMLGLAXSO-00.....	427
PA-OSMLGLAXT-00.....	429
PA-OSMLGLAXT3M-00.....	410
PA-OSMLGLAXT3M-00.....	412
PA-OSMLGLAXT3M-00.....	414
PA-OSMLGLAXT3M-00.....	416
PA-OSMLGLAXT3M-00.....	417
PA-OSTRGLAX-00.....	421
PA-OSTRGLAX-00.....	424
PA-OSTRGLAX-00.....	426
PA-OSTRGLAX-00.....	427
PA-OSTRGLAX-00.....	428
PA-OSTRGLAX-00.....	429
PA-OSTRGLAX-00.....	431
PA-OSTRGLAX-00.....	434
PA-OSTRGLAX-00.....	434
PA-OSTRGLAX3M-00.....	421
PA-OSTRGLAX3M-00.....	424
PA-OSTRGLAX3M-00.....	428
PA-OSTRGLAX3M-00.....	429
PA-OSTRGLAX3M-00.....	432
PA-OSTRGLAX3M-00.....	432
PA-OSTRGLAX3M-00.....	433
PA-OSTRGLAX3M-00.....	433
PA-OSTRGLAX3M-00.....	434
PA-OSTRGLAXM-00.....	420
PA-OSTRGLAXM-00.....	422
PA-OSTRGLAXM-00.....	425
PA-OSTRGLAXM-00.....	431
PA-OSTRGLAXM3M-00.....	420
PA-OSTRGLAXM3M-00.....	430
PA-ROZGLAX-53.....	426
PA-ROZGLAXP-53.....	426
PA-SPRGLAXM-00.....	420
PA-SPRGLAXM-00.....	422

PA-SPRGLAXM-00.....	427
PA-SPRGLAXMIC-00.....	418
PA-SPRGLAXMIC-00.....	429
PA-USZGLAX-00N.....	428
PA-USZGLAX-10N.....	428
PA-ZASGLAX-00.....	424
PA-ZASGLAX-10.....	424
PA-ZASGLAX-20M.....	424
PA-ZASGLAX-90.....	424
PA-ZASGLAXDR-00.....	426
PA-ZASGLAXKT-00.....	434
PA-ZASGLAXMIC-00.....	423
PA-ZASGLAXMICNK-00.....	418
PA-ZASGLAXMNK-00.....	420
PA-ZASGLAXMNK-10.....	420
PA-ZASGLAXMNK-20M.....	420
PA-ZASGLAXMNK-90.....	420
PA-ZASGLAXMNMK-00.....	420
PA-ZASGLAXMNMK-00.....	420
PA-ZASGLAXMNMK-10.....	420
PA-ZASGLAXMNMK-20M.....	420
PA-ZASGLAXMNMK-90.....	420
PA-ZASGLAXMNMK-00.....	420
PA-ZASGLAXMNMK-00.....	420
PA-ZASGLAXMNMK-10.....	422
PA-ZASGLAXMNMK-10.....	422
PA-ZASGLAXMNMK-20M.....	422
PA-ZASGLAXMNMK-90.....	422
PA-ZASGLAXMW-00.....	425
PA-ZASGLAXMW-10.....	425
PA-ZASGLAXMW-20M.....	425
PA-ZASGLAXMW-90.....	425
PA-ZASGLAXMWK-00.....	425
PA-ZASGLAXNK-00.....	421
PA-ZASGLAXNKKT-00.....	429
PA-ZASGLAXNKKT-10.....	429
PA-ZASGLAXNKKT-20M.....	429
PA-ZASGLAXNKKT-90.....	429
PA-ZASGLAXNKKT-00.....	429
PA-ZASGLAXNKKT-10.....	429
PA-ZASGLAXNKKT-20M.....	429
PA-ZASGLAXNKKT-90.....	429
PA-ZASGLAXNKKT-00.....	429
PA-ZASGLAXRAD-00.....	427
PA-ZAWGLAXDR-00.....	426
PA-ZAWGLAXDR-00.....	427
PA-ZGLAXKTOMZ-00.....	436
PA-ZGLAXMNMK-00.....	435
PA-ZGLAXMNMK-10.....	435
PA-ZGLAXMNMK-20M.....	435
PA-ZGLAXMNMK-10.....	436
PA-ZGLAXMNMK-20M.....	436
PA-ZGLAXOMZ-00.....	435
PA-ZGLAXOMZ-10.....	435
PA-ZGLAXOMZ-20M.....	435
PC-ELE724-00.....	379
PC-ELE724-SC.....	379
PC-MECH24-00.....	379
PC-MECH24-SC.....	379

R

RF-HB150W-40.....	134
RM-DE625X625-00.....	75
RM-KNG60X60-00.....	75
RM-KNG300X120-00.....	75
RM-KNG300X600-00.....	75
RM-LUNA120-00.....	172
RM-LUNA120-10.....	172
RM-MA60X60-00.....	75

S

SA1.....	139
SA2.....	139
SO-TK060DE-00.....	133
SO-TK069DE-00.....	133
SO-TK090DE-00.....	133
SO-TK612DE-00.....	133
SW-HLSZT809W-60.....	61
SW-HLSZT818W-120.....	61
SW-HLSZT824W-150.....	61
SW-NSZT810W-60N.....	61
SW-NSZT818W-120N.....	61

SW-NSZT822W-150N.....	61
SW-ZSZT810W-60N.....	61
SW-ZSZT818W-120N.....	61
SW-ZSZT822W-150N.....	61

T

TLD-12W38LN-NB0.....	334
TLD-12W38LN-NB1.....	334
TLD-20W38LN-NB0.....	334
TLD-20W38LN-NB1.....	334
TLD-30W38LN-NB0.....	334
TLD-30W38LN-NB1.....	334

W

WZL-2.....	390
WZL-3.....	390
WZL-4.....	390

X

XAE-BNADB-00.....	347
XAE-BNADC-10.....	347
XAE-GNSCH-00.....	347
XAE-HMKB-00.....	347
XAE-HMKC-10.....	347
XAE-KZASLB-00.....	339
XAE-KZASLC-10.....	339
XAE-KZASPB-00.....	339
XAE-KZASPC-10.....	339
XAE-LELUB-00.....	344
XAE-LELUC-10.....	344
XAE-LELZB-00.....	344
XAE-LELZC-10.....	344
XAE-LKELB-00.....	341
XAE-LKELC-10.....	341
XAE-LKLLZB-00.....	340
XAE-LKLLZC-10.....	340
XAE-LKLPWB-00.....	340
XAE-LKLPWC-10.....	340
XAE-LKLRZWB-00.....	340
XAE-LKLRZWC-10.....	340
XAE-LKRUB-00.....	344
XAE-LKRUC-10.....	344
XAE-LKTRZWL-00.....	342
XAE-LKTRZWLC-10.....	342
XAE-LKTRZWPB-00.....	343
XAE-LKTRZWPC-10.....	343
XAE-LKTWLB-00.....	342
XAE-LKTWLC-10.....	342
XAE-LKTWPB-00.....	343
XAE-LKTWPC-10.....	343
XAE-LKTZLB-00.....	342
XAE-LKTZLC-10.....	342
XAE-LKTZPB-00.....	343
XAE-LKTZPC-10.....	343
XAE-LXXUB-00.....	341
XAE-LXXUC-10.....	341
XAE-LMIZB-00.....	346
XAE-LMIZC-10.....	346
XAE-MS120B-00.....	346
XAE-MS120C-10.....	346
XAE-MSEZB-00.....	346
XAE-MSEZC-10.....	346
XAE-MSUNB-00.....	345
XAE-MSUNC-10.....	345
XAE-ZKUNCB-00.....	341
XAE-ZKUNCC-10.....	341
XAE-ZZWECLB-00.....	345
XAE-ZZWECLC-10.....	345
XAE-ZZWL120B-00.....	345
XAE-ZZWL120C-10.....	345
XLD-1524XLN-NB0.....	336
XLD-1560XLN-NB0.....	336
XLD-3024XLN-NB0.....	336

XLD-3024XLN-NB1.....	336
XLD-3060XLN-NB0.....	336
XLD-3060XLN-NB1.....	336
XLD-4024XLN-NB0.....	336
XLD-4060XLN-NB0.....	336
XLD-GRSGU10KB-NB.....	328
XLD-GRSGU10KC-NB.....	328
XLD-GRSGU10OB-NB.....	328
XLD-GRSGU10OC-NB.....	328
XLD-LKSWLGAB-00.....	330
XLD-LKSWLGAC-00.....	330
XLD-LKSWLGBB-00.....	330
XLD-LKSWLGB-00.....	330
XLD-LKSWLGCC-00.....	330
XLD-LKSWLGCC-00.....	330
XLD-LMAGU10KB-NB.....	326
XLD-LMAGU10KC-NB.....	326
XLD-LMAGU10OB-NB.....	326
XLD-LMAGU10OC-NB.....	326
XLD-SRA08WB-NB.....	332
XLD-SRA08WC-NB.....	332
XLD-SRA18WB-NB.....	332
XLD-SRA18WC-NB.....	332
XLT-1FAC13A-00.....	322
XLT-1FAC19-00.....	322
XLT-1FAC21A-10.....	322
XLT-1FAC24A-10.....	322
XLT-1FAC33-00.....	322
XLT-1FAC34-10.....	322
XLT-1FAC66-00.....	322
XLT-1FAC67-10.....	322
XLT-1FAC68-00.....	322
XLT-1FAC69-10.....	322
XLT-1FAC70-00.....	322
XLT-1FAC71-10.....	322
XLT-1FAC71-10.....	322
XLT-1FAC78-00.....	322
XLT-1FAC79-10.....	322
XLT-ADOGU10-00.....	319
XLT-ADOGU10-10.....	319
XLT-ETNAES111-00.....	319
XLT-ETNAES111-10.....	319
XLT-GRSGU10KB-NB.....	321
XLT-GRSGU10KC-NB.....	321
XLT-GRSGU10OB-NB.....	321
XLT-GRSGU10OC-NB.....	321
XLT-LMAGU10KB-NB.....	320
XLT-LMAGU10KC-NB.....	320
XLT-LMAGU10OB-NB.....	320
XLT-LMAGU10OC-NB.....	320
XLT-ORI-GU10-00.....	318
XLT-ORI-GU10-10.....	318
XLT-Z3OP20SZ1B-00.....	318
XLT-Z3OP20SZ1B-10.....	318
XTR-RA3FZ1B-00.....	339
XTR-RA3FZ1C-10.....	339
XTR-RA3FZ2B-00.....	339
XTR-RA3FZ2C-10.....	339

Z

ZM-PANELSC-00.....	74
ZM-PANELSU-00.....	74

Niniejszy katalog produktów został przygotowany przez GTV Poland. Poprzez ciągłe udoskonalanie swojej oferty, zgodnie z wymogami rynkowymi i prawnymi, GTV Poland zastrzega sobie prawo do wprowadzania zmian w przedstawionym asortymencie. Prezentowana publikacja nie jest ofertą w rozumieniu Kodeksu Cywilnego. Rzeczywiste produkty mogą odbiegać od poglądowych zdjęć i rysunków zamieszczonych w publikacji. GTV Poland zastrzega sobie prawo do zmian i błędów w druku.

This product catalogue has been prepared by GTV Poland. Constantly improving its products so as to follow market and legal requirements, GTV Poland reserves the right to introduce changes in the presented product range. The present publication does not constitute an offer within the meaning of the Civil Code. The real products can differ from the example photographs and drawings in the publication. GTV Poland reserves the right to make changes and printing errors.

Данный каталог был создан компанией GTV Poland. В соответствии с действующим законодательством и требованиями рынка, компания GTV Poland оставляет за собой право вносить изменения в ассортимент предлагаемого товара. Данная публикация носит информационно-ознакомительный характер и не является коммерческим предложением в понимании права. Компания не несет ответственности за возможные цветовые расхождения, опечатки и неточности.

Даний каталог був створений компанією GTV Poland. Відповідно до чинного законодавством і вимогами ринку, компанія GTV Poland залишає за собою право вносити зміни в асортимент пропонованого товару. Дана публікація носить інформаційно-ознайомчий характер і не є комерційною пропозицією в розумінні права. Компанія не несе відповідальності за можливі колірні розбіжності, помилки і неточності.

GTV

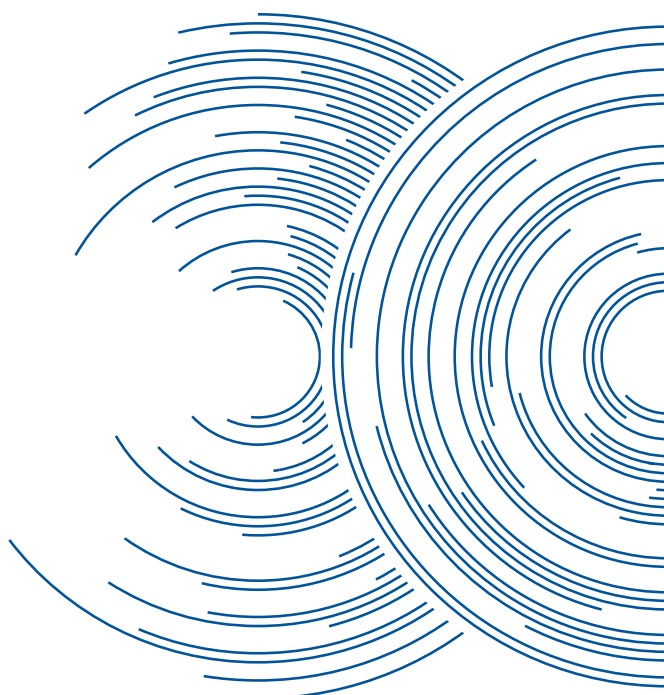

ul. Przejazdowa 21
05-800 Pruszków
Poland

 +48 22 44 47 595

 +48 22 44 47 366
+48 22 44 47 287

 +48 22 44 47 394

 +48 22 44 47 379

 +420 591 160 091

 +48 22 44 47 338
 +48 22 44 47 338

 +48 22 44 47 552
 +48 22 44 47 552
 +48 22 44 47 552

 +48 22 4447 251
 +48 22 4447 251
 +48 22 4447 251

 +48 22 4447 251

 GTV Croatia d.o.o.
ul. Roberta Frangeša Mihanovića 9,
10110 Zagreb, Hrvatska
+ 385 1 798 8089

 GTV Czech Distribution s.r.o.
CTPark Ostrava, Na Rovince 879
720 00 Ostrava-Hrabová
Česká republika
+420 591 160 091
objednavky.ostrava@gtv.com.pl

 GTV España Herrajes e Iluminación, S.L.
Avenida Aragón 30, Planta 8
46021 Valencia (España)
+ 34 961 134 441
+ 48 22 44 47 377
gtv@gtv.es

fax: +48 22 444 75 01
e-mail: oswietlenie@gtv.com.pl
east.lighting@gtv.com.pl
www.gtvdecor.com
Follow us on

